

ENGINE BASE

SERVICE MANUAL

**ISUZU
4JG2**

REFERENCE ONLY

- FORK LIFT(HDF20-30, -2 SERIES)

HYDRA

FOREWORD

This Workshop Manual is designed to help you perform necessary maintenance, service, and repair procedures on applicable Isuzu industrial engines.

Information contained in this Workshop Manual is the latest available at the time of publication.

Isuzu reserves the right to make changes at any time without prior notice.

This Workshop Manual is applicable to 1996 and later models.

NOTICE

Before using this Workshop Manual to assist you in performing engine service and maintenance operations, it is recommended that you carefully read and thoroughly understand the information contained in Section - 1 under the headings "General Repair Instruction" and "Notes on The Format of This Manual"

TABLE OF CONTENTS

SECTION 1.	GENERAL INFORMATION.....	1
SECTION 2.	MAINTENANCE	19
SECTION 3.	ENGINE ASSEMBLY (1) (DISASSEMBLY)	31
SECTION 4.	ENGINE ASSEMBLY (2) (INSPECTION AND REPAIR)	49
SECTION 5.	ENGINE ASSEMBLY (3) (REASSEMBLY)	85
SECTION 6.	LUBRICATING SYSTEM	113
SECTION 7.	COOLING SYSTEM	125
SECTION 8.	FUEL SYSTEM.....	135
SECTION 9.	ENGINE ELECTRICALS	147
SECTION 10.	TROUBLESHOOTING.....	173
SECTION 11.	SPECIAL TOOL LIST	199
SECTION 12.	CONVERSION TABLE.....	203

SECTION 1

GENERAL INFORMATION

TABLE OF CONTENTS

ITEM	PAGE
General repair instructions	2
Notes on the format of this manual	2
Main data and specifications	6
Tightening torque specifications	7
Augular nut and bolt tightening method	9
Special parts fixing nuts and bolts	11

GENERAL REPAIR INSTRUCTIONS

1. Before performing any service operation with the engine mounted, disconnect the grounding cable from the battery.
This will reduce the chance of cable damage and burning due to short circuiting.
2. Always use the proper tool or tools for the job at hand.
Where specified, use the specially designed tool or tools.
3. Use genuine ISUZU parts.
4. Never reuse cotter pins, gaskets, O-rings, lock washers, and self locking nuts. Discard them as you remove them. Replace them with new ones.
5. Always keep disassembled parts neatly in groups. This will ensure a smooth reassembly operation.
It is especially important to keep fastening parts separate. These parts vary in hardness and design, depending on their installation position.
6. All parts should be carefully cleaned before inspection or reassembly.
Oil ports and other openings should be cleaned with compressed air to make sure that they are completely free of obstructions.
7. Rotating and sliding part surfaces should be lubricated with oil or grease before reassembly.
8. If necessary, use a sealer on gaskets to prevent leakage.
9. Nut and bolt torque specifications should be carefully followed.
10. Always release the air pressure from any machine-mounted air tank(s) before dismantling the engine or disconnecting pipes and hoses. To not do so is extremely dangerous.
11. Always check and recheck your work. No service operation is complete until you have done this.

NOTES ON THE FORMAT OF THIS MANUAL

This Workshop Manual is applicable to ISUZU industrial engine or engines which is or are stated in the title.

When more than two engine models are dealt in the manual, such engines have common parts and components as well as data and specifications, unless otherwise specified.

1. Find the applicable section by referring to the Table of Contents at the beginning of the Manual.
2. Common technical data such as general maintenance items, service specifications, and tightening torques are included in the "General Information" section.
The section ENGINE ASSEMBLY is an exception. This parts are divided in three sections to facilitates indexing.
3. Each section is divided into sub-sections dealing with disassembly, inspection and repair, and reassembly.

4. When the same servicing operation is applicable to several different units, the manual will direct you to the appropriate page.
5. For the sake of brevity, self-explanatory removal and installation procedures are omitted. More complex procedures are covered in detail.
6. Each service operation section in this Workshop Manual begins with an exploded view of the applicable area. A brief explanation of the notation used follows.

Disassembly Steps - 2

1. Water by-pass hose
2. Thermostat housing
3. Water pump
- ▲ 4. Injection nozzle holder
5. Glow plug and glow plug connector
6. Cylinder head cover
- ▲ 7. Rocker arm shaft and rocker arm
8. Push rod
- ▲ 9. Cylinder head

10. Cylinder head gasket
- ▲ 11. Crankshaft damper pulley with dust seal
12. Timing gear case cover
13. Timing gear cover
14. Timing gear oil pipe
15. Idler gear "B" and shaft
- ▲ 16. Idler gear "A"
- ▲ 17. Idler gear shaft

Inverted Engine

Parts marked with an asterisk (*) are included in the repair kit.

Parts within a square frame are to be removed and installed as a single unit, and their disassembly steps or reassembly steps are shown in the illustrations respectively.

The number tells you the service operation sequence.

Removal of unnumbered parts is unnecessary unless replacement is required.

The "* Repair Kit" indicates that a repair kit is available.

The parts listed under "Disassembly Steps" or "Reassembly Steps" are in the service operation sequence.

The removal or installation of parts marked with a triangle (▲) is an important operation. Detailed information is given in the text.

GENERAL INFORMATION

7. Below is a sample of the text of the Workshop Manual.

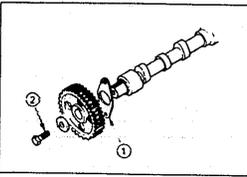

4. Camshaft Timing Gear

- 1) Install the thrust plate ①.
- 2) Apply engine oil to the bolt threads ②.
- 3) Install the camshaft timing gear with the timing mark stamped side facing out.

Camshaft Timing Gear Bolt Torque kg·m(lb.ft/N·m)

11.0 ± 1.0 (79.5 ± 7.2/107.8 ± 9.8)

This is the item shown in the illustration. It is marked with a triangle (▲) on the Major Components page.

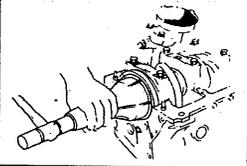

13. Crankshaft Rear Oil Seal

- 1) Apply engine oil to the oil seal lip circumference and the oil seal outer circumference.
- 2) Use the oil seal installer to install the oil seal to the cylinder body.

Oil Seal Installw: 5-8840-0141-0

Letters and numbers contained in a circle refer to the illustration.

Special tools are identified by the tool name and/or number. The illustration shows how the special tool is to be used.

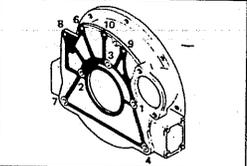

14. Flywheel Housing

- 1) Apply liquid gasket to the shaded area shown in the illustration.
- 2) Tighten the flywheel housing bolts to the specified torque a little at a time in the sequence shown in the illustration.

Flywheel Housing Bolt Torque kg·m(lb.ft/N·m)

M10×1.25 (0.40×0.05) Bolt	5.6±1.0 (40.5±7.2/ 54.9±9.8)
M12×1.25 (0.47×0.05) Bolt	10.5±1.0 (76.0±7.2/103.0±9.8)
M12×1.75 (0.47×0.07) Bolt	9.8±1.0 (71.0±7.2/ 96.0±9.8)

Symbols indicate the type of service operation or step to be performed. A detailed explanation of these symbols follows.

Service data and specifications are given in this table.

8. The following symbols appear throughout this Workshop Manual. They tell you the type of service operation or step to perform.

 Removal	 Adjustment
 Installation	 Cleaning
 Disassembly	 Important operation requiring extra care
 Reassembly	 Specified torque (tighten)
 Alignment (marks)	 Special tool use required or recommended (Isuzu tool or tools)
 Directional indication	 Commercially available tool use required or recommended
 Inspection	 Lubrication (oil)
 Measurement	 Lubrication (grease)
	 Sealant application

9. Measurement criteria are defined by the terms "standard" and "limit".

A measurement falling within the "standard" range indicates that the applicable part or parts are serviceable.

"Limit" should be thought of as an absolute value.

A measurement which is outside the "limit" indicates that the applicable part or parts must be either repaired or replaced.

10. Components and parts are listed in the singular form throughout the Manual.

11. Directions used in this Manual are as follows:

Front

The cooling fan side of the engine viewed from the flywheel.

Right

The right hand side viewed from the same position.

Left

The left hand side viewed from the same position.

Rear

The flywheel side of the engine.

Cylinder numbers are counted from the front of the engine.

The front most cylinder is No. 1 and rear most cylinder is the final cylinder number of the engine.

The engine's direction of rotation is counterclockwise viewed from the flywheel.

MAIN DATA AND SPECIFICATIONS

Engine Model		4JG2
Item		
Engine type		Water cooled, four-cycle, in-line, overhead valve
Combustion chamber type		Swirl chamber
Cylinder liner type		Dry
No. of cylinders - Bore x Stroke	mm(in.)	4 - 95.4 x 107 (3.76 x 4.21)
Total piston displacement	cc(cid)	3,059 (187)
Compression ratio (To 1)		20.1
*Engine dimensions	mm(in.)	710 x 555 x 733 (28.0 x 21.9 x 28.9)
Length x Width x Height		
*Engine weight (Dry)	kg(lb.)	244 (538)
Fuel injection order		1 - 3 - 4 - 2
*Fuel injection timing (B.T.D.C.)	degrees	6
Specified fuel		Diesel fuel
Injection pump		Bosch VE type
Governor		Mechanical, type
*Low idle speed	rpm	675 - 725
Injection nozzle		Throttle type
Injection starting pressure	MPa(kg/cm ² /psi)	14.7 (150/2,130)
Fuel filter type		Cartridge paper element
Water sedimentor (if so equipped)		Sediment/water level indicating type
Compression pressure	MPa(kg/cm ² /psi)	2.94 (30/427)
Valve clearance (at cold)	Intake mm(in.)	0.40 (0.016)
	Exhaust mm(in.)	0.40 (0.016)
Lubrication method		Pressurized circulation
Oil pump		Trochoid type
Main oil filter type		Cartridge paper element, full flow
Partial oil filter		Not equipped
*Lubricating oil volume	lit.(US/gal.)	7.5 (1.98)
Oil cooler (if so equipped)		Water cooled built in oil filter
Cooling method		Pressurized forced circulation
Coolant volume (engine only)	lit.(US/gal.)	4.5 (1.19)
Water pump		Belt driven impeller type
Thermostat type		Wax pellet type
*Alternator	V-A	12 - 35
*Starter	V-kW	12 - 2.2

Specifications marked with an asterisk (*) will vary according to engine application.

TIGHTENING TORQUE SPECIFICATIONS

The tightening torque values given in the table below are applicable to the bolts unless otherwise specified.

STANDARD BOLT

kg·m (lb.ft/N·m)

Strength Class	4.8 (4T)	(7T)	8.8		9.8 (9T)
			Refined	Non-Refined	
Bolt Identification					
Bolt Diameter × pitch (mm)	 No mark	—			
M 6 × 1.0	0.4 ~ 0.8 (2.9 ~ 5.8/3.9 ~ 7.8)		0.5 ~ 1.0 (3.6 ~ 7.2/4.9 ~ 9.8)		—
M 8 × 1.25	0.8 ~ 1.8 (5.8 ~ 13.0/7.8 ~ 17.7)		1.2 ~ 2.3 (8.7 ~ 16.6/11.8 ~ 22.6)		1.7 ~ 3.1 (12.3 ~ 22.4/16.7 ~ 30.4)
M10 × 1.25	2.1 ~ 3.5 (15.2 ~ 25.3/20.6 ~ 34.3)		2.8 ~ 4.7 (20.3 ~ 34.0/27.5 ~ 46.1)		3.8 ~ 6.4 (27.5 ~ 46.3/37.3 ~ 62.8)
M12 × 1.25	5.0 ~ 7.5 (36.2 ~ 54.2/49.0 ~ 73.6)		6.2 ~ 9.3 (44.8 ~ 67.3/60.8 ~ 91.2)		7.7 ~ 11.6 (55.7 ~ 83.9/75.5 ~ 113.8)
M14 × 1.5	7.8 ~ 11.7 (56.4 ~ 84.6/78.5 ~ 114.7)		9.5 ~ 14.2 (68.7 ~ 102.7/93.2 ~ 139.3)		11.6 ~ 17.4 (83.9 ~ 125.6/113.8 ~ 170.6)
M16 × 1.5	10.6 ~ 16.0 (76.7 ~ 115.7/103.0 ~ 156.9)		13.8 ~ 20.8 (99.8 ~ 150.4/135.3 ~ 204.0)		16.3 ~ 24.5 (118.9 ~ 177.2/159.9 ~ 240.3)
M18 × 1.5	15.4 ~ 23.0 (111.1 ~ 166.4/151.0 ~ 225.6)		19.9 ~ 29.9 (143.9 ~ 216.3/195.2 ~ 391.3)		23.4 ~ 35.2 (169.3 ~ 254.6/229.5 ~ 345.2)
M20 × 1.5	21.0 ~ 31.6 (151.9 ~ 228.6/205.9 ~ 307.9)		27.5 ~ 41.3 (198.9 ~ 298.7/269.7 ~ 405.0)		32.3 ~ 48.5 (233.6 ~ 350.8/316.8 ~ 475.6)
M22 × 1.5	25.6 ~ 42.2 (185.2 ~ 305.2/251.1 ~ 413.8)		37.0 ~ 55.5 (267.6 ~ 401.4/362.9 ~ 544.3)		43.3 ~ 64.9 (313.2 ~ 469.4/424.6 ~ 636.5)
M24 × 2.0	36.6 ~ 55.0 (264.7 ~ 397.8/358.9 ~ 539.4)		43.9 ~ 72.5 (317.5 ~ 523.9/430.5 ~ 711.0)		56.5 ~ 84.7 (408.7 ~ 612.6/554.1 ~ 830.6)
*M10 × 1.5	2.0 ~ 3.4 (14.5 ~ 24.6/19.6 ~ 32.4)		2.8 ~ 4.6 (20.3 ~ 33.3/27.5 ~ 45.1)		3.7 ~ 6.1 (26.8 ~ 44.1/36.3 ~ 59.8)
*M12 × 1.5	4.6 ~ 7.0 (33.3 ~ 50.6/45.1 ~ 68.7)		5.8 ~ 8.6 (42.0 ~ 62.2/56.9 ~ 84.3)		7.3 ~ 10.9 (52.8 ~ 78.8/71.6 ~ 106.9)
*M14 × 2.0	7.3 ~ 10.9 (52.8 ~ 78.8/71.6 ~ 106.9)		9.0 ~ 13.4 (65.1 ~ 96.9/88.3 ~ 131.4)		10.9 ~ 16.3 (78.8 ~ 118.9/106.9 ~ 159.9)
*M16 × 2.0	10.2 ~ 15.2 (73.8 ~ 110.0/100.0 ~ 149.1)		13.2 ~ 19.8 (95.5 ~ 143.2/129.5 ~ 194.2)		15.6 ~ 23.4 (112.8 ~ 169.3/162.8 ~ 229.5)

An asterisk (*) indicates that the bolts are used for female threaded parts that are made of soft materials such as casting. Those shown in parentheses in the strength class indicate the classification by the old standard.

TIGHTENING TORQUE SPECIFICATIONS

The tightening torque values given in the table below are applicable to the bolts unless otherwise specified.

FLANGED HEAD BOLT

kg·m (lb.ft/N·m)

Bolt head marking Nominal size (dia. x pitch)			
M 6 × 1	0.5 ~ 0.9 (3.61 ~ 6.50/4.6 ~ 8.5)	0.6 ~ 1.2 (4.33 ~ 8.67/5.88 ~ 11.76)	—
M 8 × 1.25	1.1 ~ 2.0 (7.95 ~ 14.46/10.78 ~ 19.61)	1.4 ~ 2.9 (4.33 ~ 8.67/5.88 ~ 11.76)	1.9 ~ 3.4 (13.74 ~ 24.59/18.63 ~ 33.34)
M10 × 1.25	2.3 ~ 3.9 (17.35 ~ 28.20/23.53 ~ 38.24)	3.6 ~ 6.4 (26.03 ~ 44.12/35.30 ~ 59.82)	4.3 ~ 7.2 (31.10 ~ 52.07/42.16 ~ 70.60)
*M10 × 1.5	2.3 ~ 3.8 (16.63 ~ 27.48/22.55 ~ 37.26)	3.5 ~ 5.8 (25.31 ~ 41.95/34.32 ~ 56.87)	4.1 ~ 6.8 (29.65 ~ 49.18/40.20 ~ 66.68)
M12 × 1.25	5.6 ~ 8.4 (40.50 ~ 60.75/54.91 ~ 82.37)	7.9 ~ 11.9 (57.14 ~ 86.07/77.47 ~ 116.69)	8.7 ~ 13.0 (62.92 ~ 94.02/85.31 ~ 127.48)
*M12 × 1.75	3.5 ~ 9.5 (37.61 ~ 56.41/50.99 ~ 76.49)	7.3 ~ 10.9 (52.80 ~ 78.83/71.58 ~ 106.89)	8.1 ~ 12.2 (58.58 ~ 88.24/79.43 ~ 119.64)
M14 × 1.5	8.5 ~ 12.7 (61.48 ~ 91.85/83.35 ~ 124.54)	11.7 ~ 17.6 (84.62 ~ 127.30/114.73 ~ 172.59)	12.6 ~ 18.9 (91.13 ~ 136.70/123.56 ~ 185.34)
*M14 × 2	7.6 ~ 11.5 (57.14 ~ 85.34/77.47 ~ 115.71)	11.1 ~ 16.6 (80.28 ~ 120.06/108.85 ~ 162.79)	11.8 ~ 17.7 (85.34 ~ 128.02/115.71 ~ 173.57)
M16 × 1.5	11.8 ~ 17.7 (85.34 ~ 128.02/115.71 ~ 173.57)	17.1 ~ 26.5 (125.85 ~ 189.50/170.63 ~ 256.93)	18.0 ~ 27.1 (130.19 ~ 196.01/176.52 ~ 265.76)
*M16 × 2	11.2 ~ 16.7 (81.00 ~ 120.79/109.83 ~ 163.77)	16.6 ~ 24.9 (120.06 ~ 180.10/162.79 ~ 244.18)	17.2 ~ 25.7 (124.40 ~ 186.61/168.67 ~ 253.01)

A bolt with an asterisk (*) is used for female screws of soft material such as cast iron.

ANGULAR NUT AND BOLT TIGHTENING METHOD



1. Carefully wash the nuts and bolts to remove all oil and grease.

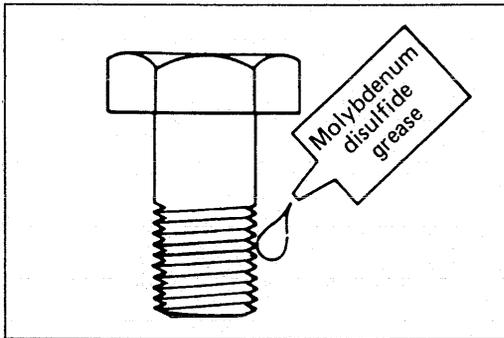

2. Apply a coat of molybdenum disulfide grease to the threads and setting faces of the nuts and bolts.

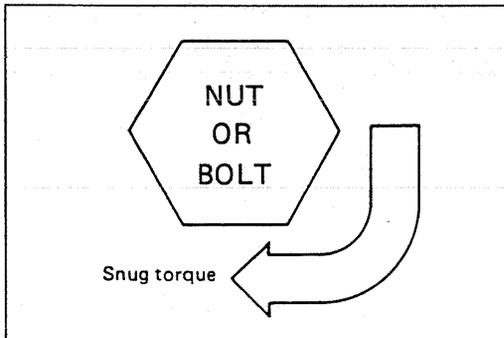

3. Tighten the nuts and bolts to the specified torque (snug torque) with a torque wrench.

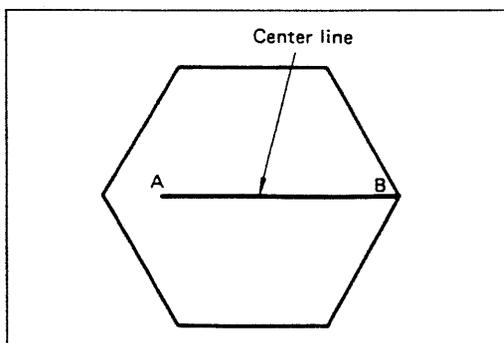

4. Draw a line [A-B] across the center of each bolt.

GENERAL INFORMATION

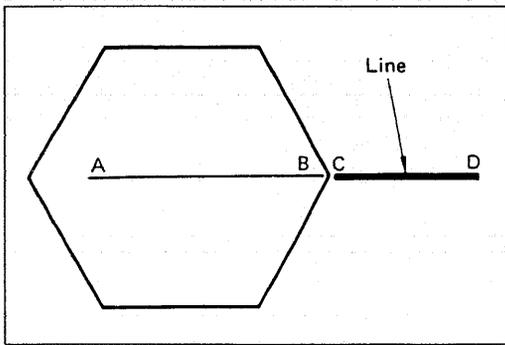

5. Draw another line (C-D) on the face of each of the parts to be clamped. This line should be an extension of the line [A-B].

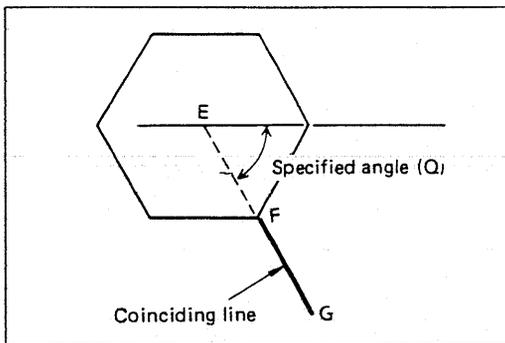

6. Draw another line [F-G] on the face of each of the parts to be clamped. This line will be in the direction of the specified angle (Q) across the center [E] of the nut or bolt.

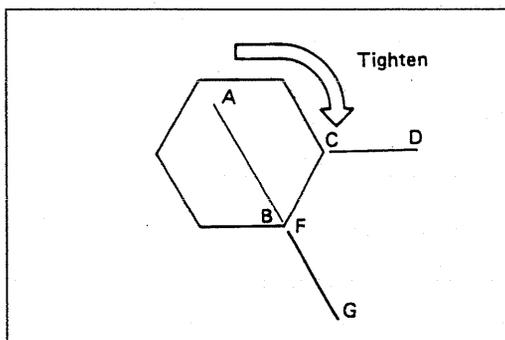

7. Use a socket wrench to tighten each nut or bolt to the point where the line [A-B] is aligned with the line [F-G].

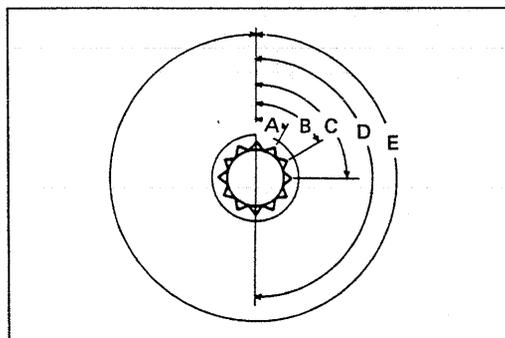

Example: Specified Angle and Tightening Rotation

A	30°	1/12 of a turn
B	60°	1/6 of a turn
C	90°	1/4 of a turn
D	180°	1/2 of a turn
E	360°	One full turn



SPECIAL PARTS FIXING NUTS AND BOLTS

Cylinder Head Cover, Cylinder Head, and Rocker Arm Shaft Bracket

kg·m(lb.ft./N·m)

0.8 - 1.8
(5.8 - 13.0/8 - 18)

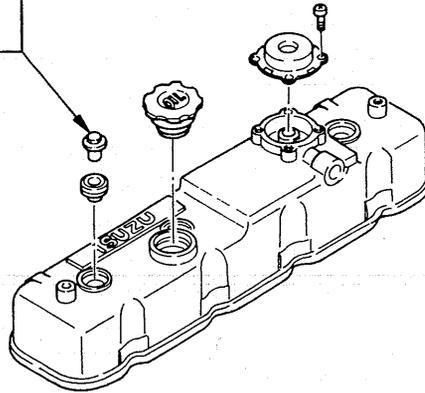

5.0 - 6.0
(36 - 43/49 - 59)

1.0 - 2.0
(7 - 14/10 - 20)

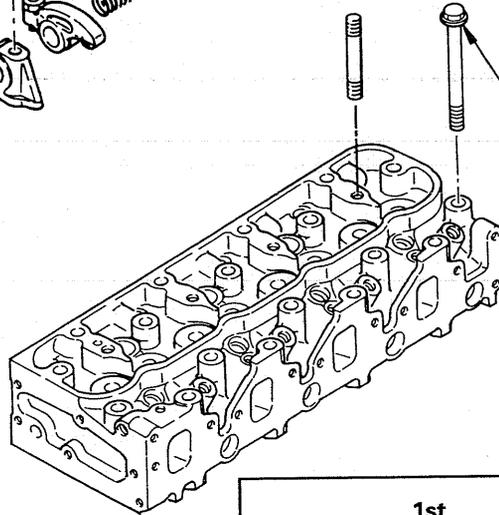
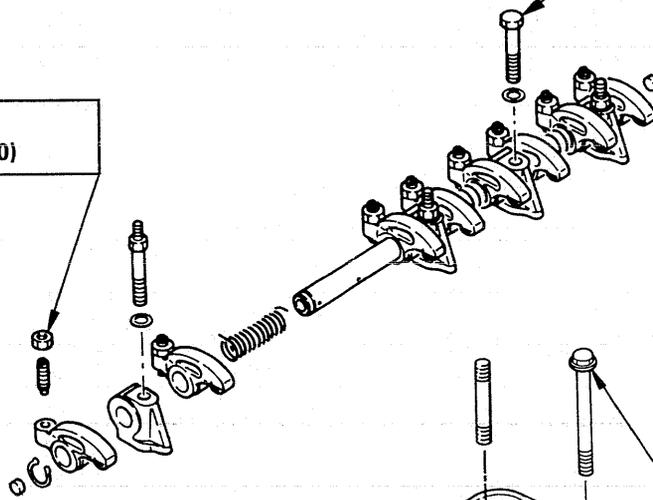

1st	2nd	3rd
4.5 - 5.5 (33 - 40/44 - 54)	60 - 75°	60 - 75°

Apply engine oil to thread portion



Crankshaft Bearing Cap, Connecting Rod Bearing Cap, Crankshaft Damper Pulley, Flywheel, and Oil Pan

kg·m(lb.ft./N·m)

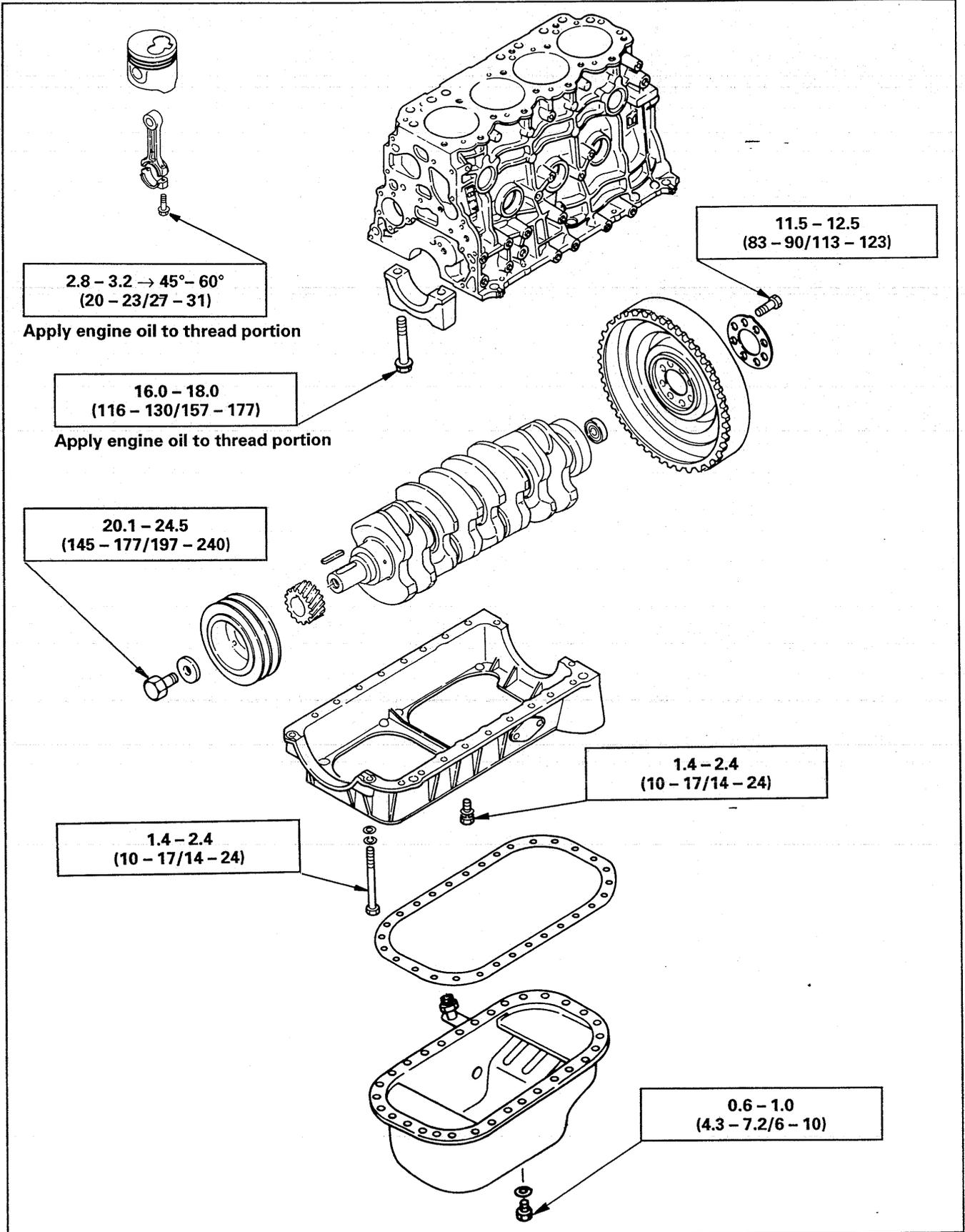



Timing Gear Case, Flywheel Housing, Camshaft, and Timing Gear

kg·m(lb.ft./N·m)

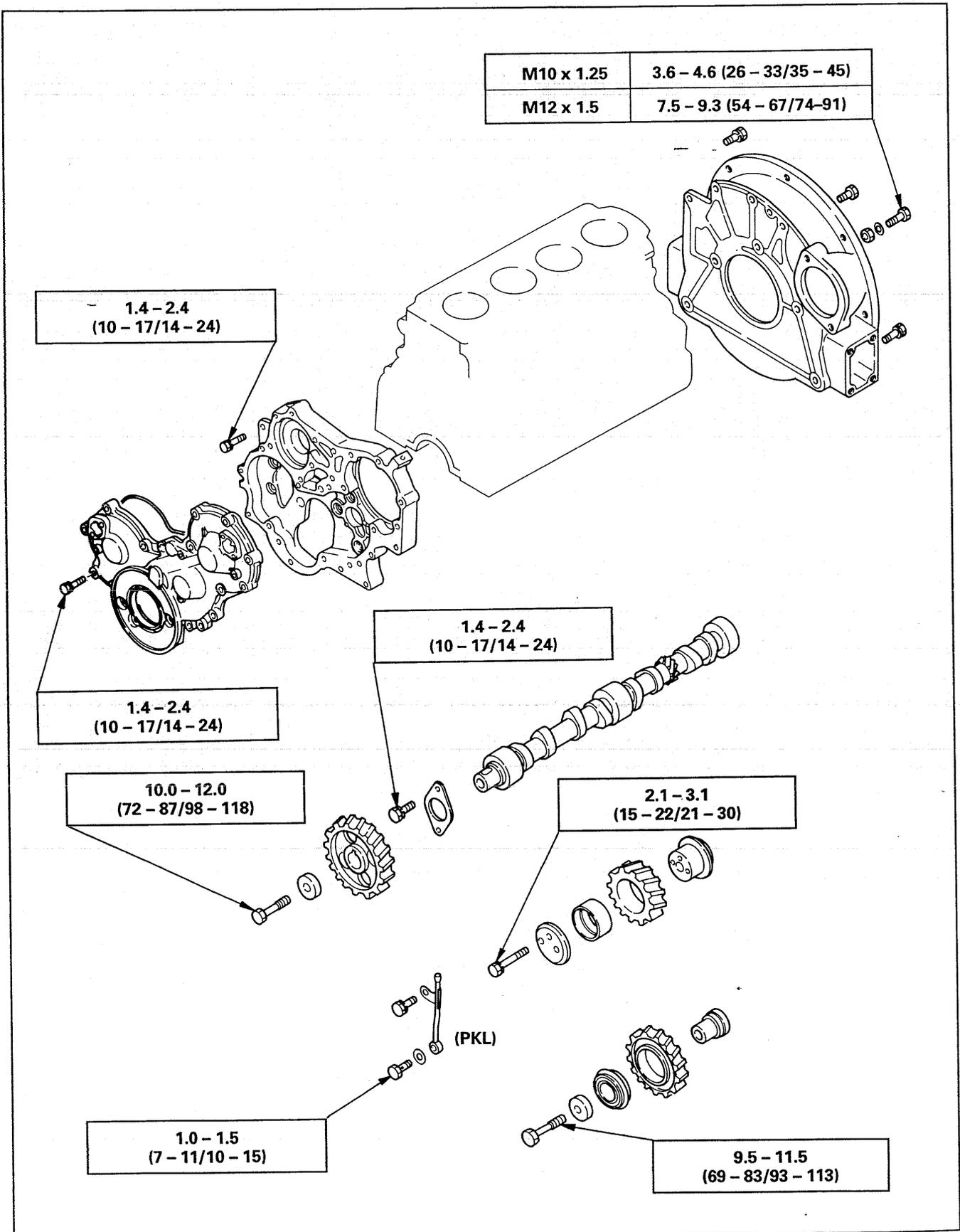



Cooling and Lubricating System

kg·m(lb.ft./N·m)

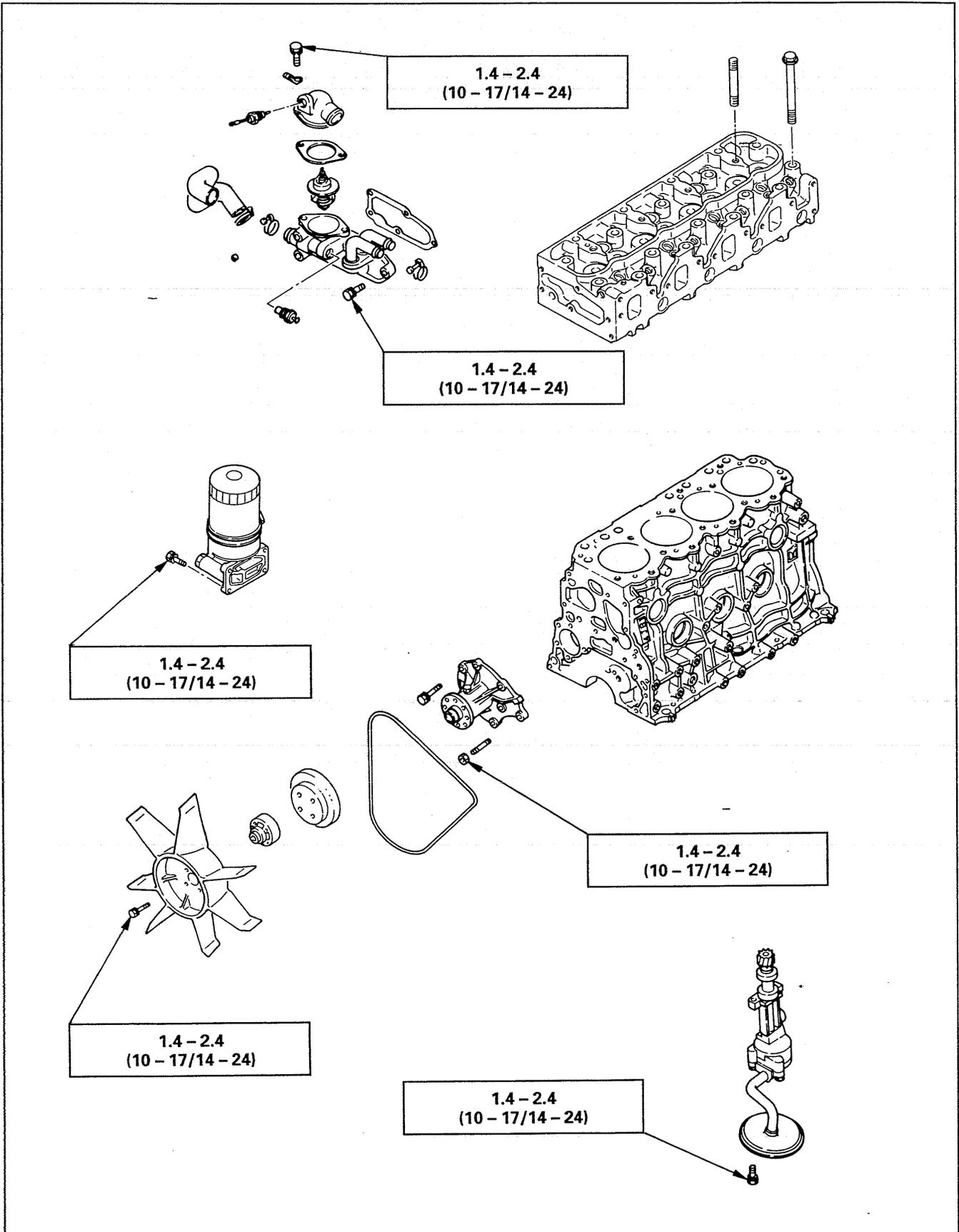



Intake and Exhaust Manifold

kg·m(lb.ft./N·m)

1.4 - 2.4
(10 - 17/14 - 24)

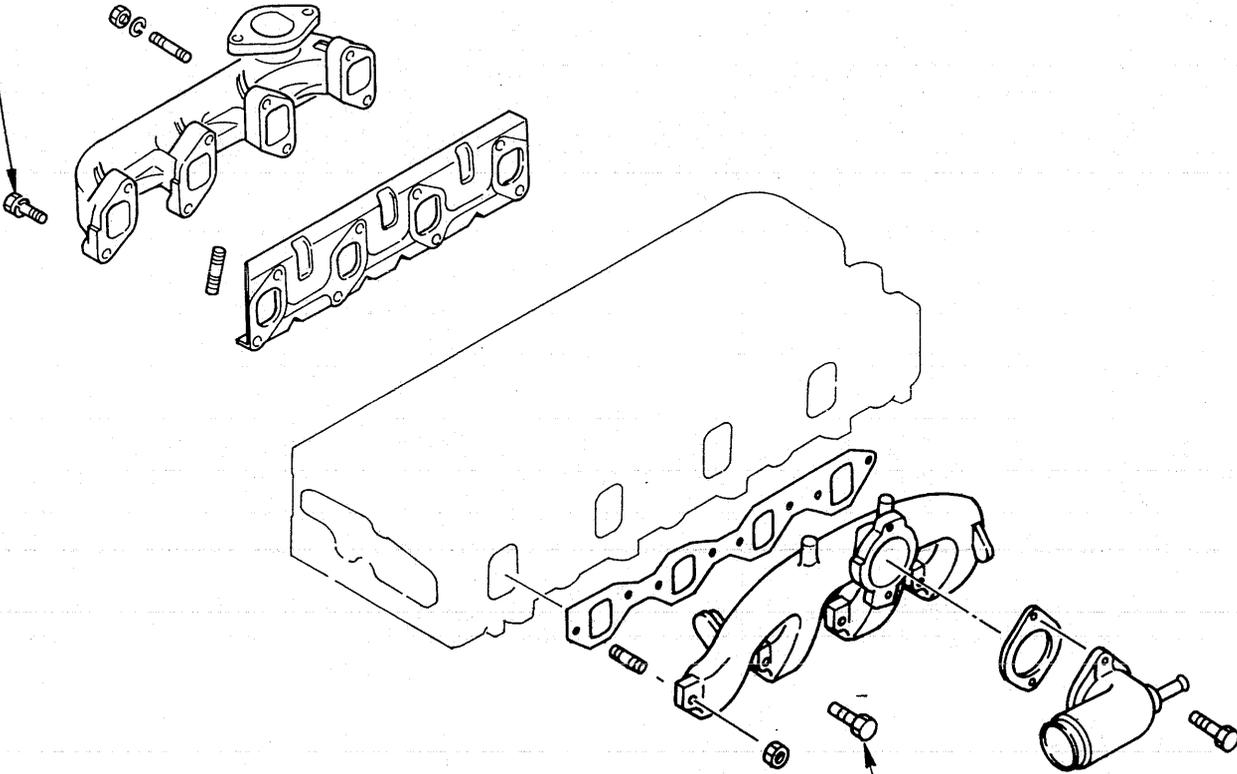

1.4 - 2.4
(10 - 17/14 - 24)



kg·m(lb.ft./N·m)

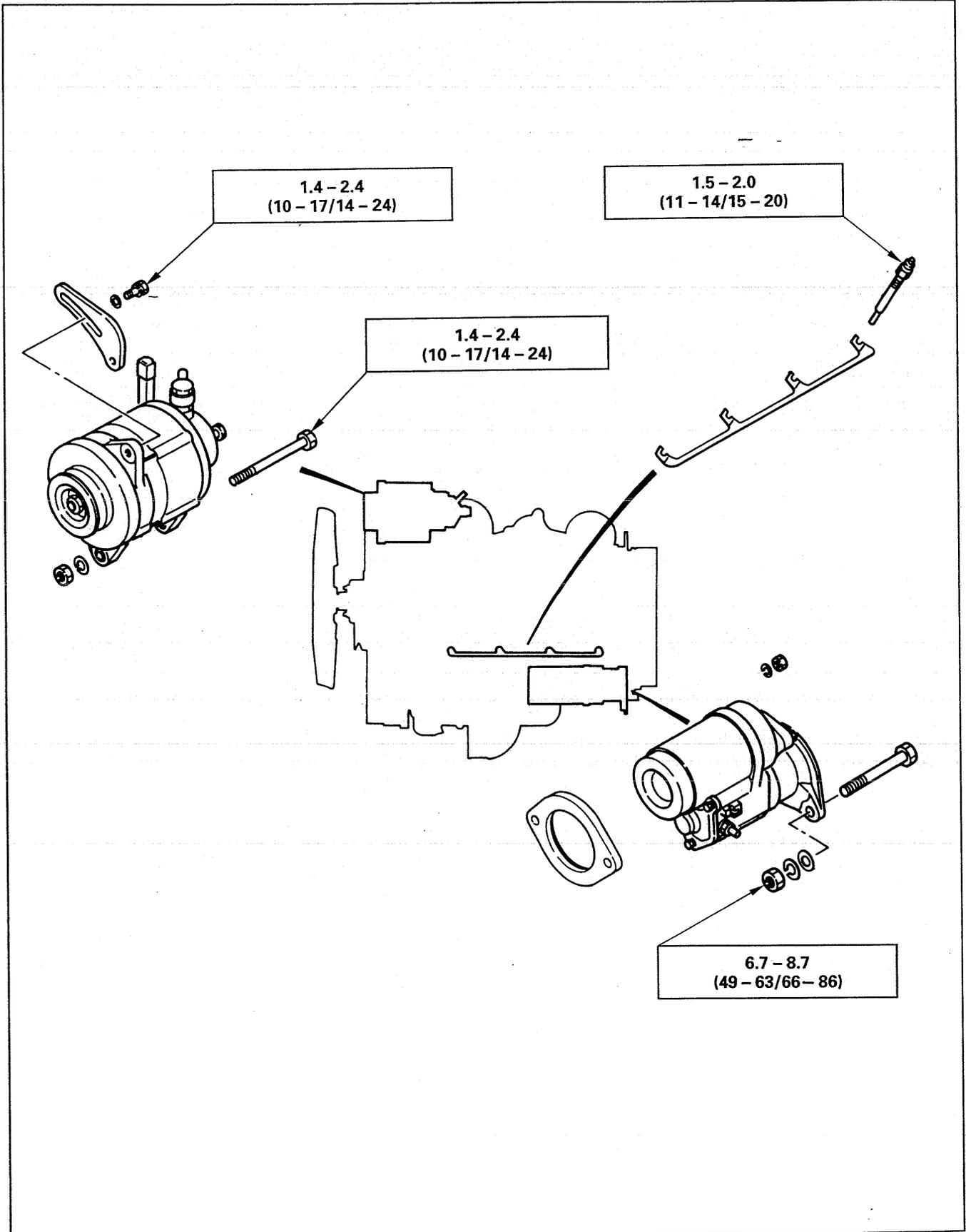



Fuel Injection System

kg·m(lb.ft./N·m)

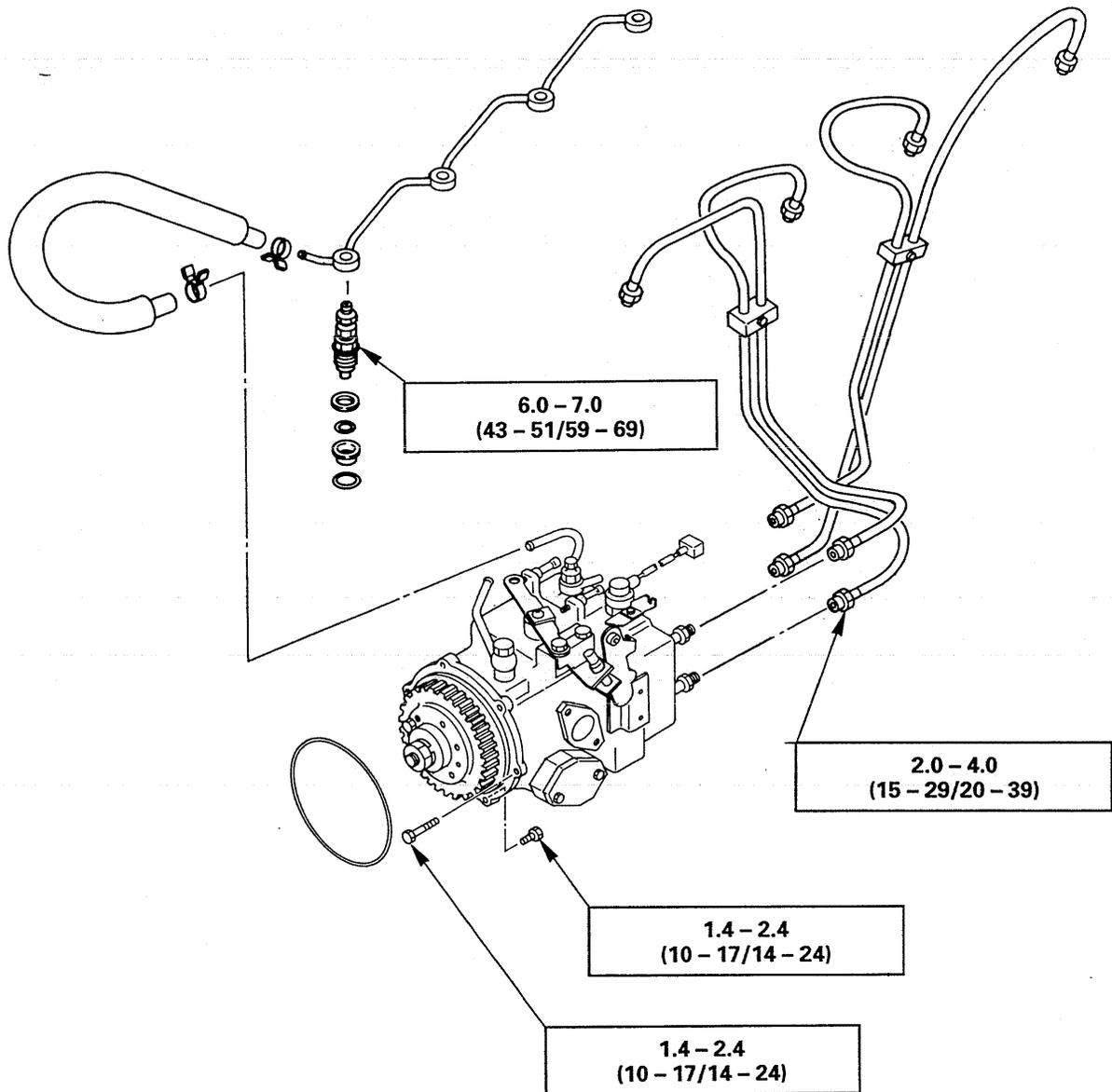

MEMO

A series of horizontal dotted lines for writing.

SECTION 2

MAINTENANCE

TABLE OF CONTENTS

ITEM	PAGE
Model identification	20
Injection pump identification	20
Lubricating system	20
Fuel system	21
Cooling system	24
Valve clearance adjustment	25
Injection timing	26
Compression pressure measurement	27
Recommended lubricants	28
Repair kits	29

MAINTENANCE

Servicing refers to general maintenance procedures to be performed by qualified service personnel. Maintenance interval such as fuel or oil filter changes should be referred to "INSTRUCTION MANUAL".

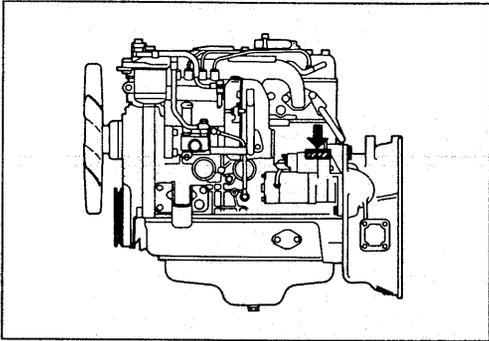

MODEL IDENTIFICATION

Engine Serial Number

The engine number is stamped on the rear left hand side of the cylinder body.

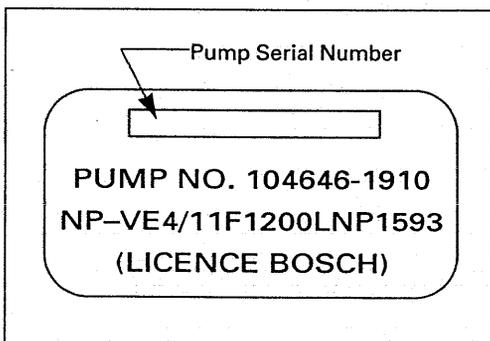

INJECTION PUMP IDENTIFICATION

Injection volume should be adjusted after referring to the adjustment data applicable to the injection pump installed.

The injection pump identification number (A) is stamped on the injection pump identifications plate.

Note:

Always check the identification number before beginning a service operation.

Applicable service data will vary according to the identification number. Use of the wrong service data will result in reduced engine performance and engine damage.

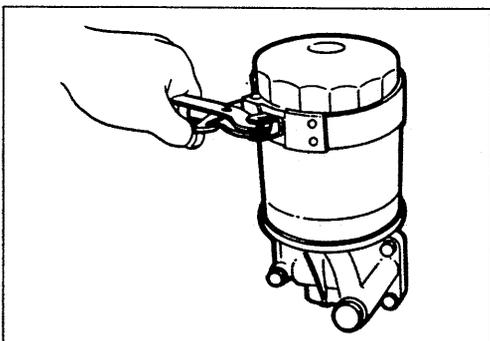

LUBRICATING SYSTEM

Main Oil Filter

Replacement Procedure

1. Loosen the drain plug to drain the engine oil.
2. Wait a few minutes and then retighten the drain plug.
3. Loosen the used oil filter by turning it counterclockwise with a filter wrench.

Filter Wrench





- Clean the oil filter fitting face.
This will allow the new oil filter to seat properly.



- Apply a light coat of engine oil to the O-ring.
- Turn in the new oil filter until the filter O-ring is fitted against the sealing face.

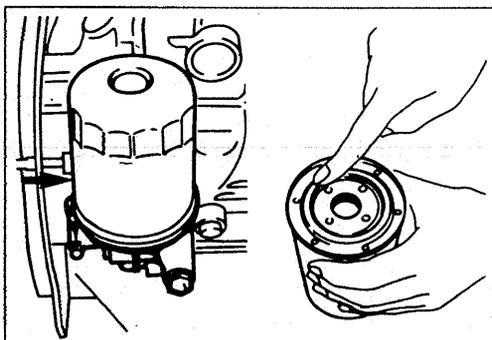

- Use a filter wrench to turn in the filter an additional 1 and 1/4 of a turn.
Filter Wrench



- Check the engine oil level and replenish to the specified level if required.
- Start the engine and check for oil leakage from the main oil filter.

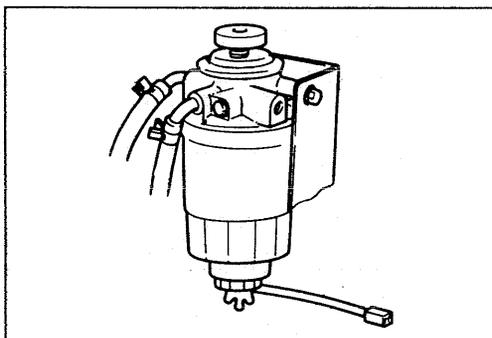

FUEL SYSTEM

Fuel Filter

Replacement Procedure



- Loosen the used fuel filter by turning it counterclockwise with the filter wrench.
Filter Wrench: 5-8840-0253-0 (J-22700)
- Remove the level sensor from the filter by turning it counterclockwise with a wrench.



- Install the level sensor to the new fuel filter with a wrench.

Level Sensor Torque	kg-m (lb-ft/N-m)
- 1.3 (9/13)	

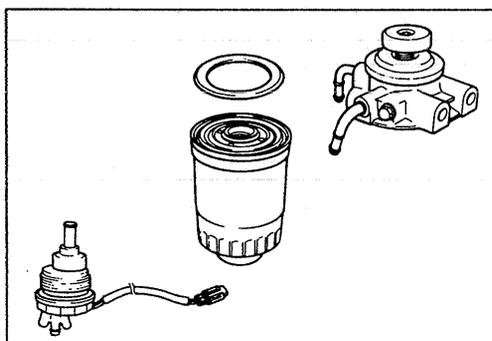

- Apply a light coat of engine oil to the O-ring.
- Turn in the fuel filter until the sealing face comes in contact with the O-ring.
- Turn in the fuel filter an additional 2/3 of a turn with a filter wrench.



Filter Wrench: 5-8840-0253-0 (J-22700)

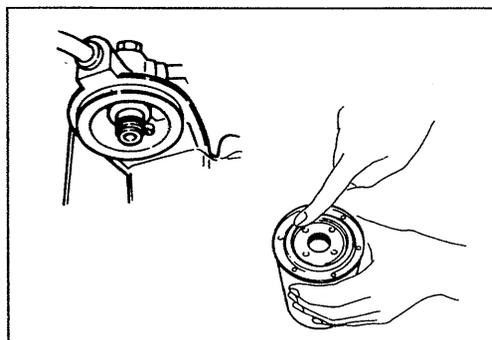

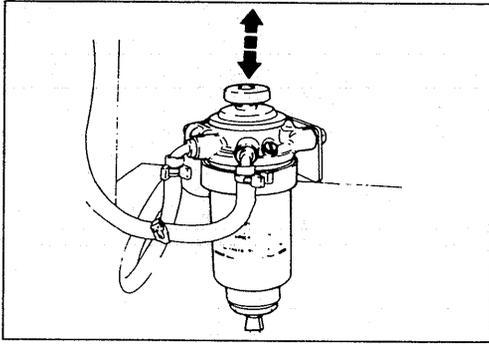

8. Loosen the bleeder plug on the injection pump overflow valve.
9. Operate the priming pump until fuel begins to flow from the fuel filter.
10. Retighten the bleeder plug.
11. Operate the priming pump several times and check for fuel leakage.

NOTE:

The use of an ISUZU genuine fuel filter is strongly recommended.



**Water Separator (Water Sedimentor)
(Optional Equipment)**

Check the water separator float ① level.

If the float ① has reached level ②, loosen the drain plug ③ (at the bottom side of the water separator) to drain the water.



Drain Plug Torque kg·m(lb.ft./N·m)

0.9 – 1.5 (6.5 – 10.9/8.8 – 14.7)

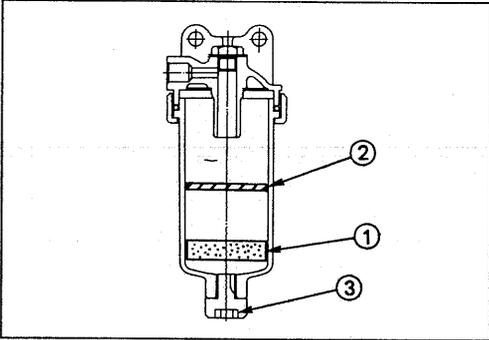

Fuel Filter with Water Level Sensor

Water Draining Procedure

The indicator light will come on when the water level in the water separator exceeds the specified level.

Drain the water and foreign material from the water separator with the following procedure.

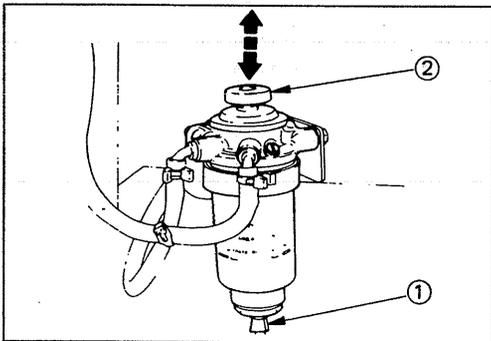

1. Open the engine hood and place a container (Approximately 0.2 liter capacity) at the end of the vinyl hose beneath the drain plug on the separator.
2. Loosen the drain plug by turning it counterclockwise (Approximately 5-turns) and operate the priming pump up and down about 10 times until water is drained approximately 0.1 liter.
3. After draining, securely tighten the drain plug by turning it clockwise and operate the priming pump manually up and down several times.
4. After starting the engine, check to see that there is no fuel leak from the drain plug.

Also check to see that the fuel filter water indicator light has turned off.

If water separator requires frequent draining, have the fuel tank drained for removal of water at your Isuzu Dealer.

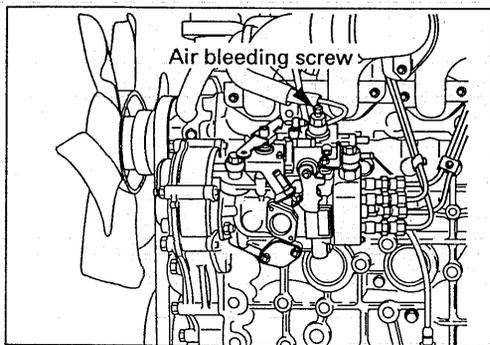

Air Bleeding

1. Loosen the bleeder screw on the injection pump overflow valve.
2. Operate the priming pump until fuel mixed with foam flows from the bleeder screw.
3. Tighten the bleeder screw.
4. Operate the priming pump several times and check for fuel leakage.

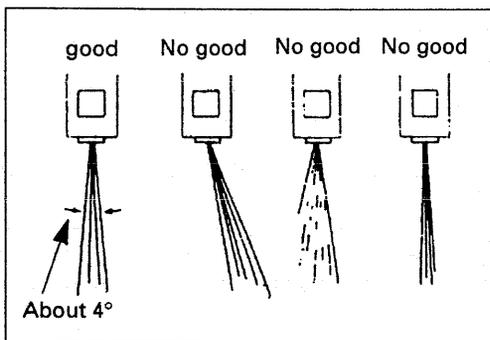
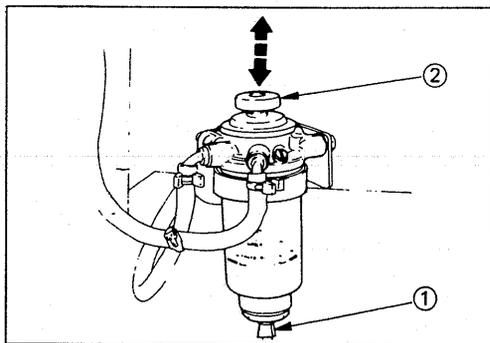

Injection nozzle

Check to see if the spray condition and the injection pressure are normal. Adjust them to the specified value respectively when they don't meet the standard value.

kg/cm² (psi/MPa)

Injection pressure	150 (2130/14.7)
--------------------	-----------------



Using a nozzle tester, adjust the injection pressure with a shim.

Special tool: Nozzle tester



WARNING:

TEST FLUID FROM THE INJECTION NOZZLE TESTER WILL SPRAY OUT UNDER HIGH PRESSURE. IT CAN EASILY PUNCTURE A PERSON'S SKIN. KEEP YOUR HANDS AWAY FROM THE INJECTION NOZZLE TESTER AT ALL TIMES.

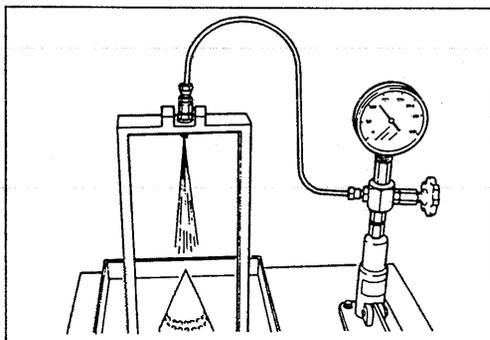

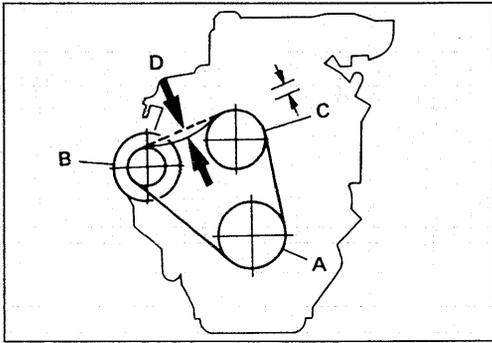

COOLING SYSTEM

Cooling Fan Drive Belt

Fan belt tension is adjusted by moving the alternator.

- A Crankshaft damper pulley
- B Alternator pulley
- C Cooling fan drive pulley
- D Depress the drive belt mid-portion with a 10 kg (22 lb/98 N) force.

Drive Belt Deflection mm(in.)

	10.0 (0.39)
--	-------------

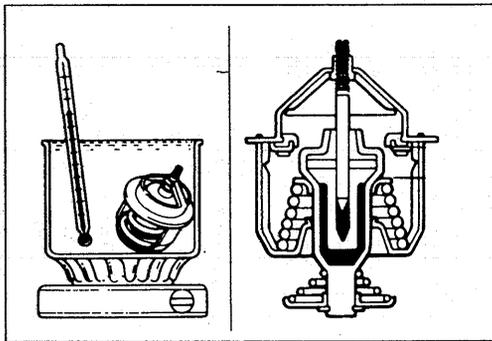

Thermostat

Operating Test

1. Completely submerge the thermostat in water.
2. Heat the water.
Stir the water constantly to avoid direct heat being applied to the thermostat.

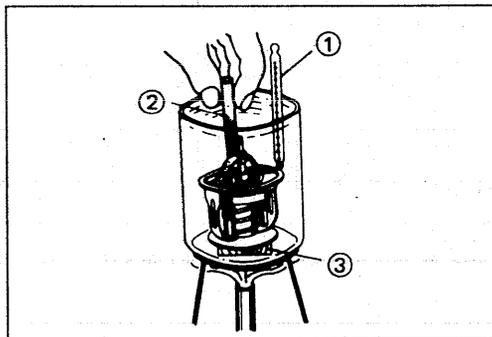

3. Check the thermostat initial opening temperature.

Thermostat Initial Opening Temperature °C(°F)

	76.5 (170)
--	------------



4. Check the thermostat full opening temperature.

Thermostat Full Opening Temperature °C(°F)

	90 (194)
--	----------



Valve Lift at Fully Open Position mm(in.)

	8.0 (0.31)
--	------------

- ① Thermostat
- ② Agitating Rod
- ③ Wooden Piece

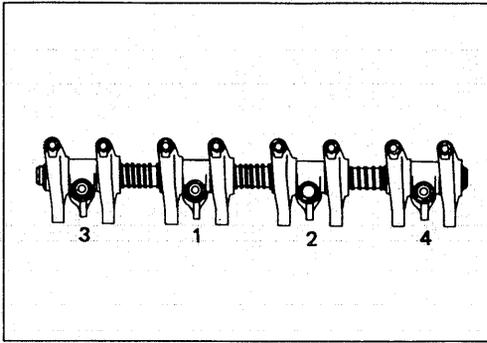

VALVE CLEARANCE ADJUSTMENT



1. Retighten the rocker arm shaft bracket bolts in sequence as shown in the illustration.

Rocker Arm Shaft Bracket Bolt
Torque

kg·m(lb.ft./N·m)

5.0 – 6.0 (36 – 43/49 – 59)

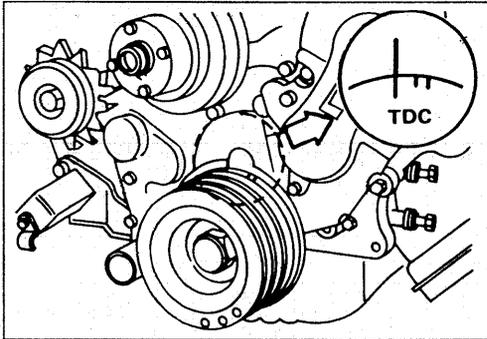

2. Bring the piston in either the No. 1 cylinder or the No. 4 cylinder to TDC on the compression stroke by turning the crankshaft until the crankshaft damper pulley TDC line is aligned with the timing pointer.

3. Check for play in the No. 1 intake and exhaust valve push rods.

If the No. 1 cylinder intake and exhaust valve push rods have play, the No. 1 piston is at TDC on the compression stroke.

If the No. 1 cylinder intake and exhaust valve push rods are depressed, the No. 4 piston is at TDC on the compression stroke.

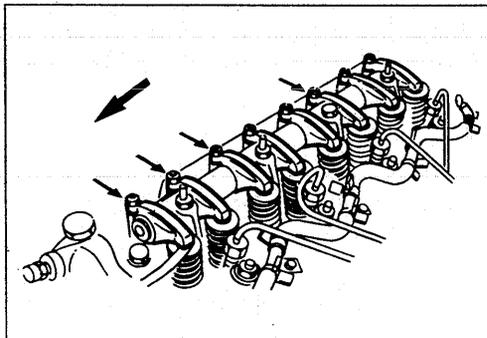

Adjust the No. 1 or the No. 4 cylinder valve clearances while their respective cylinders are at TDC on the compression stroke.

Valve Clearance

mm(in.)

0.40 (0.016)

Loosen each valve clearance adjusting screw as shown in the illustration. (At TDC on the compression stroke of the No. 1 cylinder)

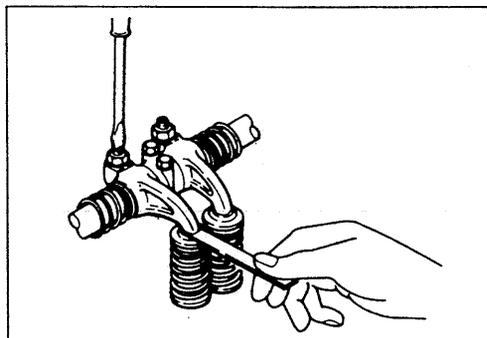

Insert a feeler gauge of the appropriate thickness between the rocker arm and the valve stem end.

4. Turn the valve clearance adjusting screw until a slight drag can be felt on the feeler gauge.
5. Tighten the lock nut securely.

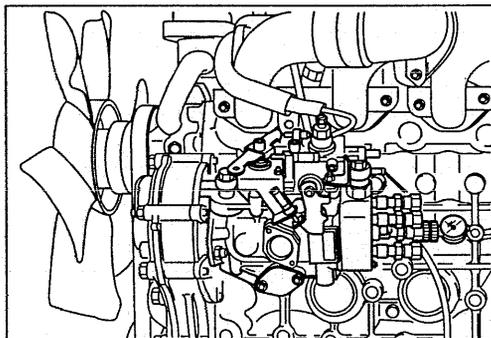
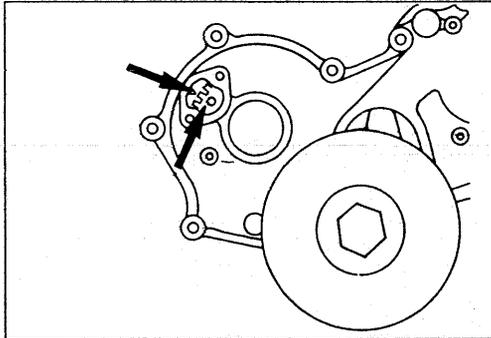
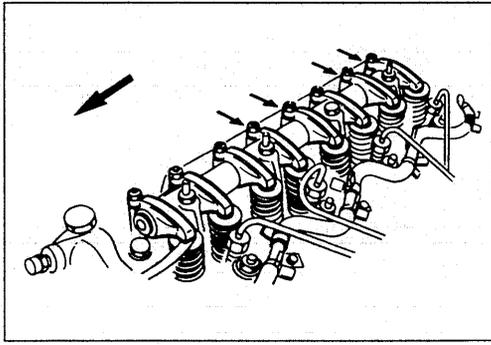

080ES002

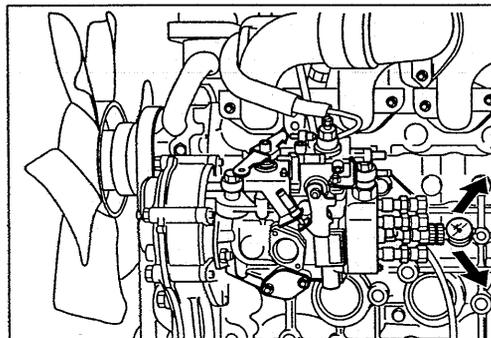

080ES003

Rotate the crankshaft 360°.

Realign the crankshaft damper pulley TDC line with the timing pointer.

Adjust the clearances for the remaining valves as shown in the illustration. (At TDC on the compression stroke of the No. 4 stroke)

INJECTION TIMING

Injection Timing Confirmation Procedure

1. Rotate the crankshaft clockwise to align the camshaft gear timing mark "O" with the timing gear case cover pointer.

The No. 1 cylinder will now be at the point where nearly injection timing.

2. Remove injector pump distributor head plug.
3. Fit a dial gauge and set lift to 1 mm.
4. Set crankshaft damper pulley Top Dead Center mark about 45° before Top Dead Center from the pointer.
5. Set dial gauge in the "0" position.

Measuring device: 5-8840-0145-0

6. Turn the crankshaft a little rightwise and leftwise and see if the pointer is stable in the "0" position.
7. Turn the crankshaft in the normal direction and read the measuring device's indication at TDC.



Starting Timing	mm (in)
0.5 (0.02)	

8. If the injection timing is outside the specified range, continue with the following steps.
9. Loosen the injection pump fixing nuts and bracket bolts.
10. Adjust the injection pump setting angle.
 - If injection timing will be advanced, move the injection pump away from the engine.
 - If injection timing will be retarded, move the injection pump toward the engine.

Tighten the pump fixing nut, adjust bolt and pump distribution head plug to the specified torque.

Pump Fixing Bolt	kg·m (lb·ft/N·m)
1.9 (13/19)	

Injection Pump Distributor Head Plug	kg·m (lb·ft/N·m)
1.7 (12/17)	

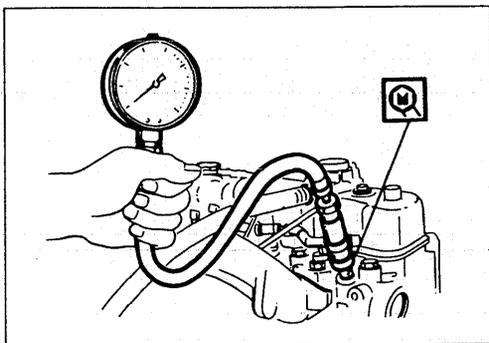

COMPRESSION PRESSURE MEASUREMENT

1. Start the engine and allow it to run for several minutes to warm it up.
2. Stop the engine and cut the fuel supply.
3. Remove all of the glow plugs from the engine.



Compression Gauge :5-8840-2008-0
 Adapter :5-8531-7001-0

4. Set a compression gauge to the No. 1 cylinder glow plug hole.
5. Turn the engine over with the starter motor and take the compression gauge reading.

Compression Pressure kg/cm²(psi/MPa) at 250 rpm

Standard	Limit
30 (427/2.94)	22 (313/2.16)

RECOMMENDED LUBRICANTS

ENGINE TYPE	TYPES OF LUBRICANTS
Without turbocharger	Diesel engine oil CC or CD grade

ENGINE OIL VISCOSITY CHART

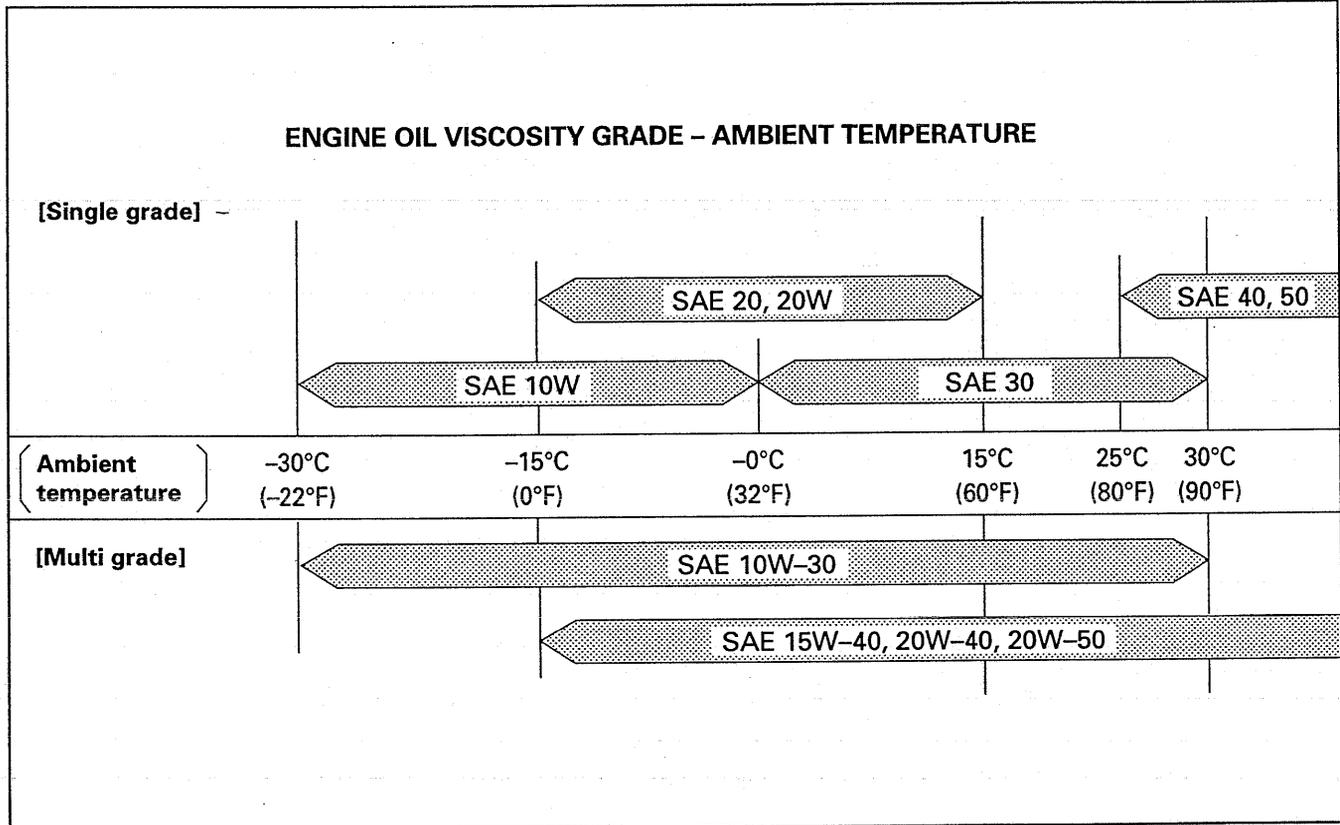

ENGINE REPAIR KIT

All of the numbered parts listed below are included in the Engine Repair Kit.

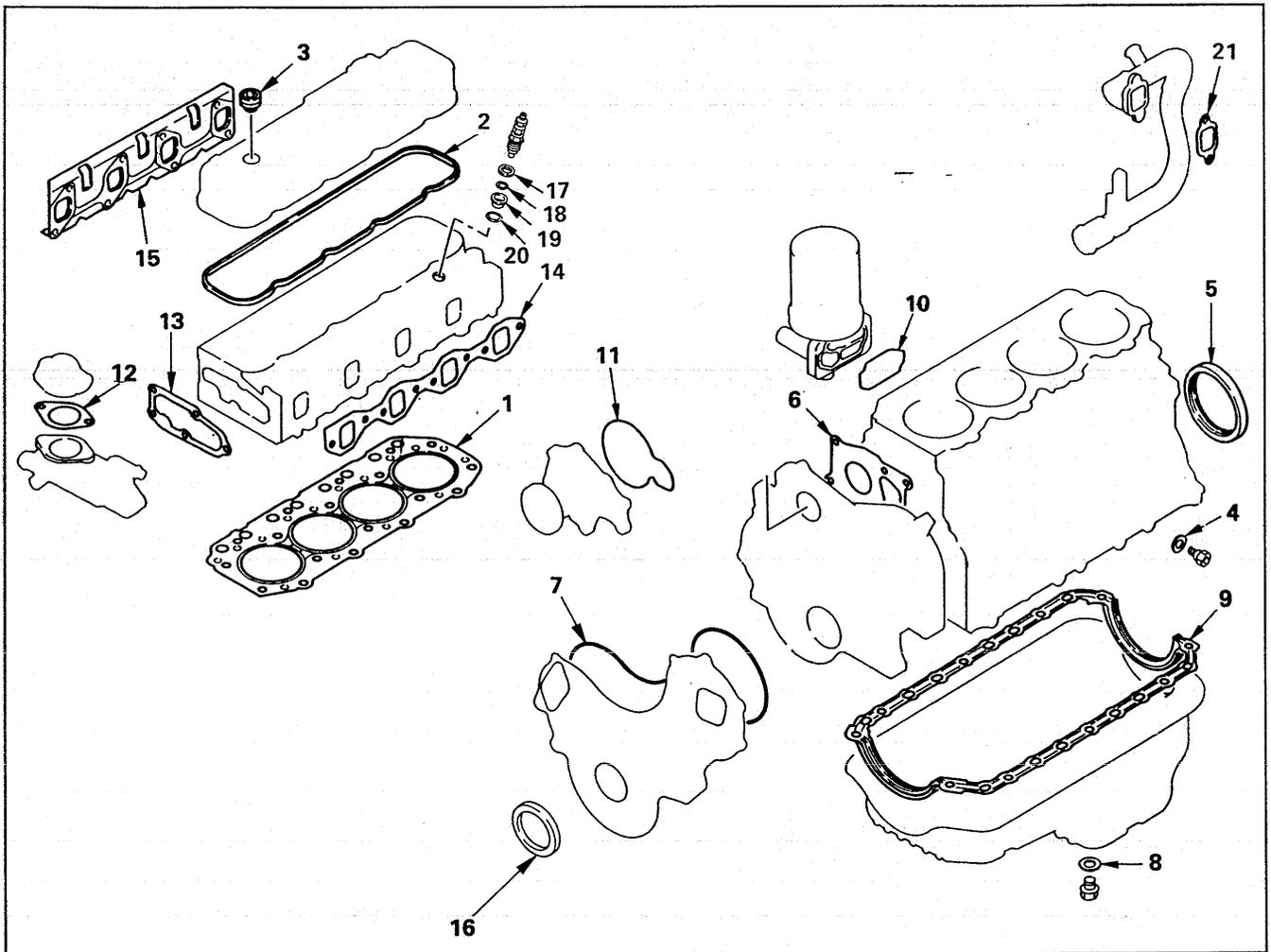

- | | |
|-------------------------------|-------------------------------|
| 1. Cylinder head gasket | 11. Water pump gasket |
| 2. Cylinder head cover gasket | 12. Water outlet pipe gasket |
| 3. Head cover cap nut gasket | 13. Thermostat housing gasket |
| 4. Drain cock gasket | 14. Intake manifold gasket |
| 5. Crankshaft rear oil seal | 15. Exhaust manifold gasket |
| 6. Gear case gasket | 16. Crankshaft front oil seal |
| 7. Gear case cover gasket | 17. Nozzle holder washer |
| 8. Oil pan drain plug gasket | 18. Corrugated washer |
| 9. Oil pan gasket | 19. Heat shield |
| 10. Oil filter gasket | 20. Heat shield washer |
| | 21. Cyl. block side gasket |

MEMO

A series of horizontal dotted lines for writing a memo.

SECTION 3

ENGINE ASSEMBLY (1)

TABLE OF CONTENTS

ITEM	PAGE
Disassembly	32



DISASSEMBLY

These disassembly steps are based on the 4JG2PE engine.

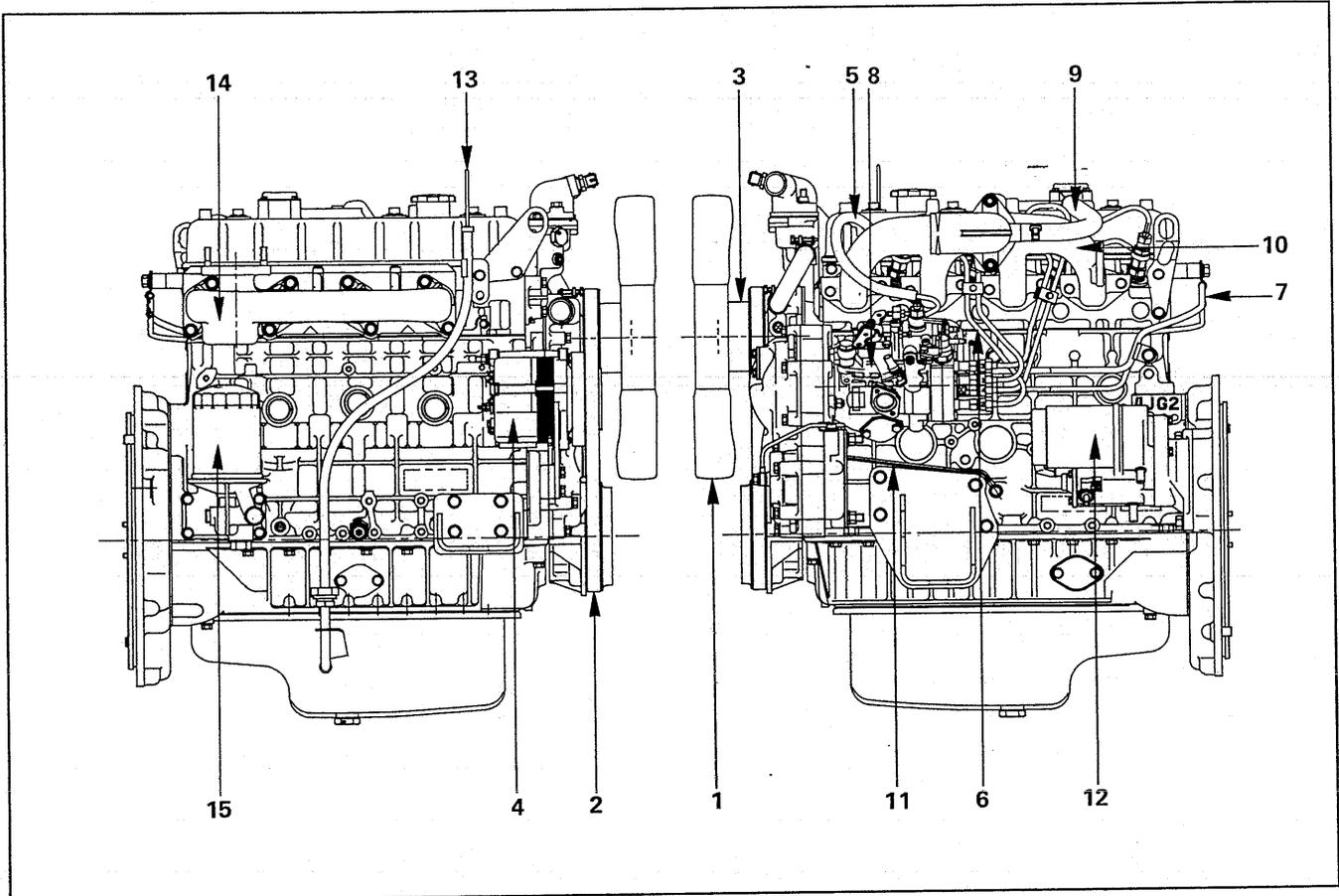

Disassembly Steps - 1

- | | |
|-----------------------------------|-----------------------------|
| 1. Cooling fan and spacer | 9. Breather hose |
| 2. Cooling fan drive belt | 10. Inlet manifold |
| 3. Cooling fan drive pulley | 11. Oil pipe |
| 4. Alternator and adjusting plate | 12. Starter motor |
| 5. Fuel hose (Leak off) | 13. Dipstick and guide tube |
| 6. Injection pipe | 14. Exhaust manifold |
| 7. Fuel pipe | 15. Oil filter |
| 8. Injection pump | |



Important Operations (Disassembly Steps - 1)

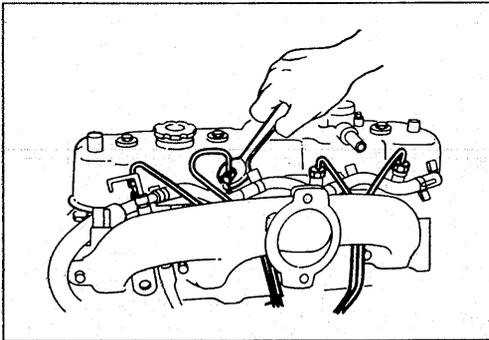

6. Fuel Injection Pipe with Clip

- 1) Loosen the injection pipe sleeve nuts at the delivery valve side.
Do not apply excessive force to the injection pipes.
- 2) Loosen the injection pipe clips.
- 3) Remove the injection pipes.

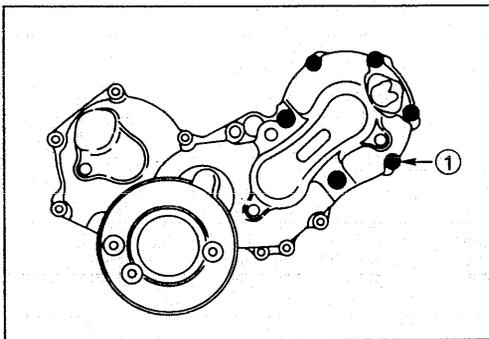

8. Injection Pump

- 1) Remove the six injection pump bracket bolts from the cylinder body timing gear case.
- 2) Pull the injection pump with the injection pump timing gear free from the rear.

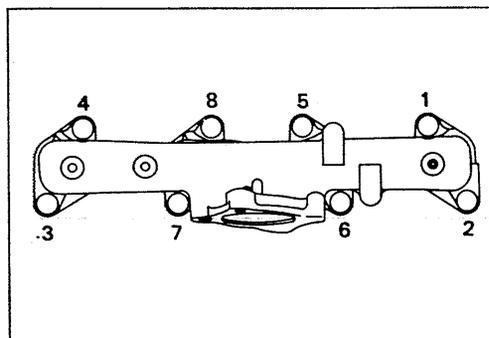
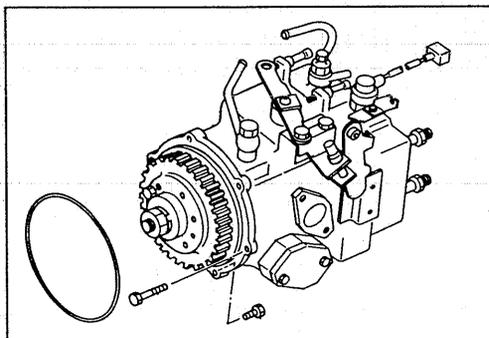

14. Exhaust Manifold

Loosen the exhaust manifold bolts a little at a time in the numerical order shown in the illustration.

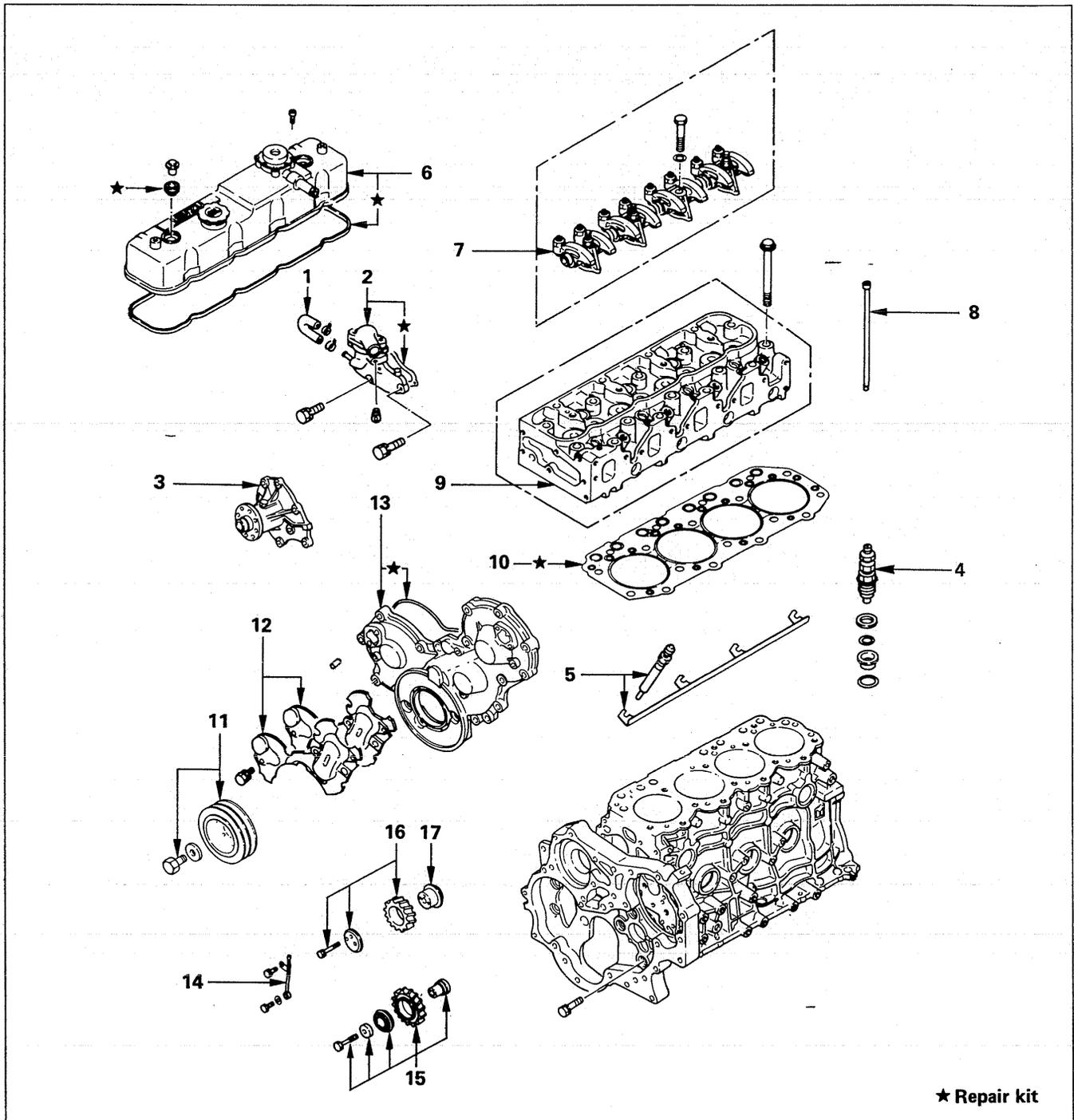

★ Repair kit

Disassembly Steps - 2

- | | |
|--------------------------------------|--------------------------------|
| 1. Water by-pass hose | 10. Cylinder head gasket |
| 2. Thermostat housing | ▲ 11. Crankshaft damper pulley |
| 3. Water pump | 12. Timing gear case cover |
| ▲ 4. Injection nozzle holder | 13. Timing gear cover |
| 5. Glow plug and glow plug connector | 14. Timing gear oil pipe |
| 6. Cylinder head cover | 15. Idler gear "B" and shaft |
| ▲ 7. Rocker arm shaft and rocker arm | ▲ 16. Idler gear "A" |
| 8. Push rod | 17. Idler gear shaft |
| ▲ 9. Cylinder head | |

Inverted Engine

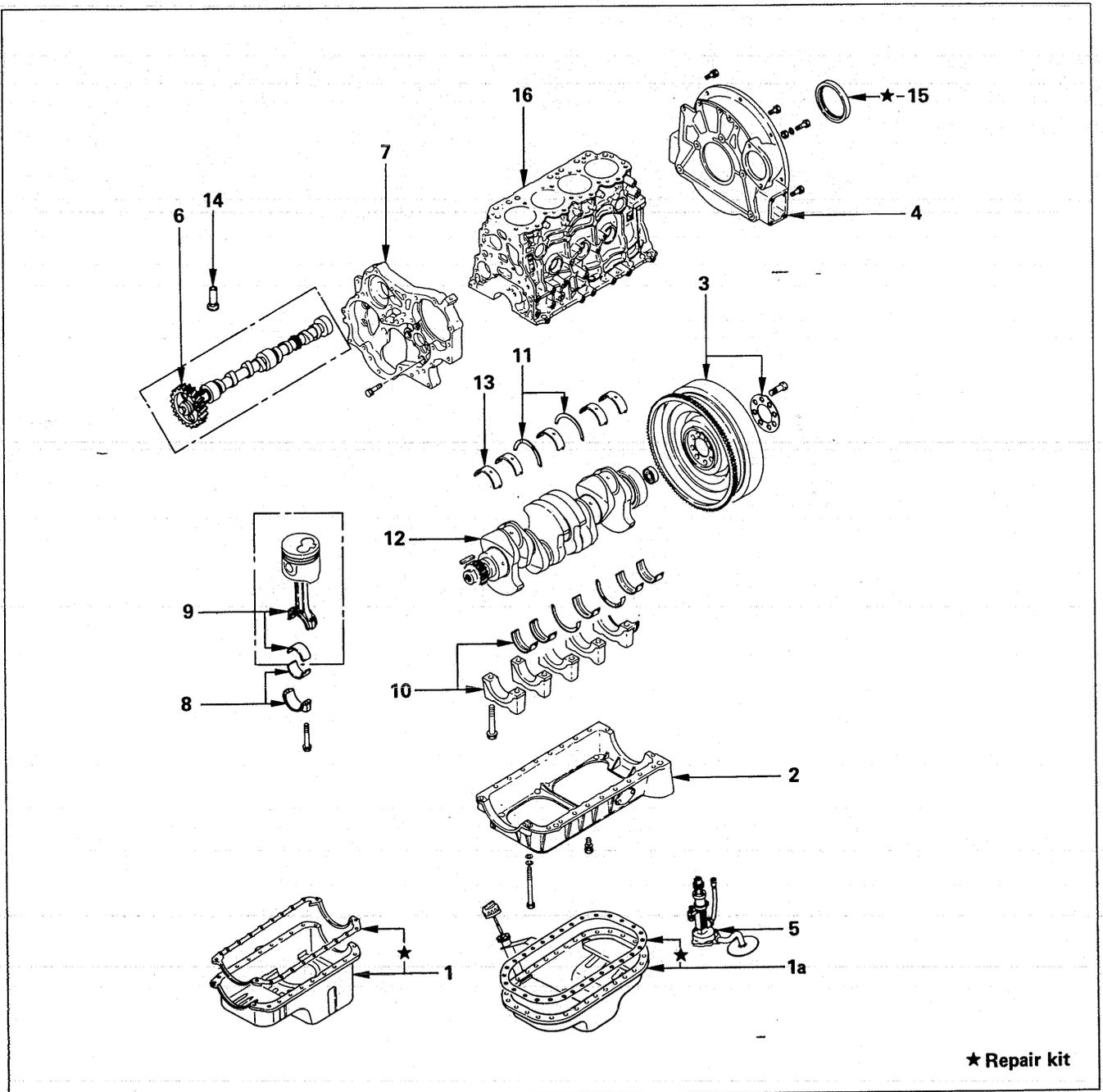

★ Repair kit

Disassembly Steps - 3

- 1. Oil pan
- 1a. Oil pan (If so equipped)
- 2. Crankcase (If so equipped)
- ▲ 3. Flywheel
- 4. Flywheel housing
- 5. Oil pump with oil pipe
- ▲ 6. Camshaft with camshaft timing gear and thrust plate
- 7. Timing gear case
- ▲ 8. Connecting rod cap with lower bearing
- ▲ 9. Piston and connecting rod with upper bearing
- ▲ 10. Crankshaft bearing cap with lower bearing
- 11. Crankshaft thrust bearing
- 12. Crankshaft with crankshaft timing gear
- ▲ 13. Crankshaft upper bearing
- ▲ 14. Tappet
- 15. Crankshaft rear oil seal
- 16. Cylinder body



Important Operations (Disassembly Steps - 2)

4. Injection Nozzle Holder

- 1) Remove the nozzle holder fixing nuts.

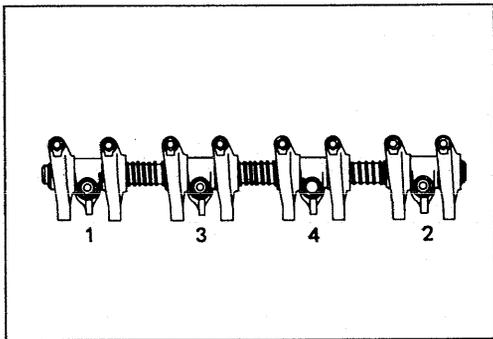

7. Rocker Arm Shaft and Rocker Arm

Loosen the rocker arm shaft bracket bolts in numerical order a little at a time.

Note:

Failure to loosen the rocker arm shaft bracket bolts in numerical order a little at a time will adversely effect the rocker arm shaft.

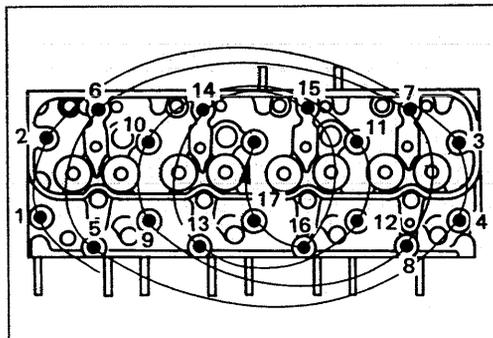

9. Cylinder Head

Loosen the cylinder head bolts in numerical order a little at a time.

Note:

Failure to loosen the cylinder head bolts in numerical order a little at a time will adversely effect the cylinder head lower surface.

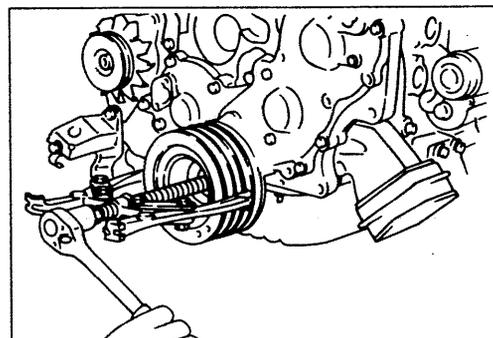

11. Crankshaft Damper Pulley

- 1) Block the flywheel with a piece of wood to prevent it from turning.
- 2) Use the damper pulley remover to remove the damper pulley.



Damper Pulley Remover

16. Idler Gear "A"



Measure the camshaft timing gear backlash, the crankshaft timing gear backlash, and the idler gear "A" end play before removing the idler gear "A" and shaft.

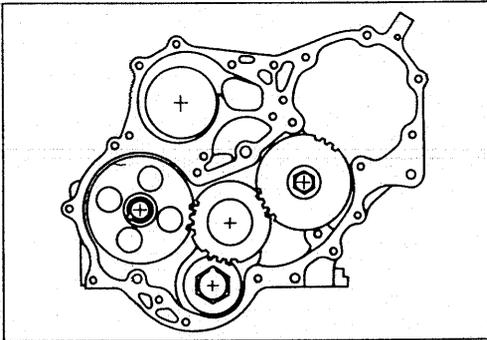

Timing Gear Backlash Measurement

- 1) Set a dial indicator to the timing gear to be measured.
Hold both the gear to be checked and the adjoining gear stationary.

- 2) Move the gear to be checked as far as possible to both the right and the left.

Take the dial indicator reading.

If the measured value exceeds the specified limit, the timing gear must be replaced.

Timing Gear Backlash mm(in.)

Standard	Limit
0.10-0.17 (0.0039-0.0067)	0.30 (0.012)

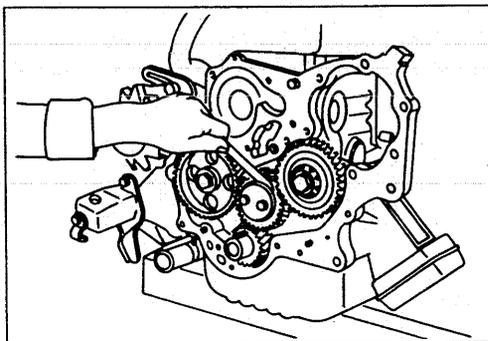

Idler Gear "A" End Play Measurement

Insert a feeler gauge between the idler gear and the thrust collar to measure the gap and determine the idler gear end play.

If the measured value exceeds the specified limit, the thrust collar must be replaced.

Idler Gear End Play mm(in.)

Standard	Limit
0.080 (0.180)	0.003 (0.007)



Important Operations (Disassembly Steps - 3)

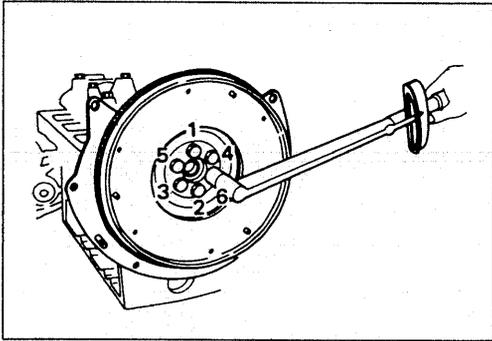

3. Flywheel

- 1) Block the flywheel with a piece of wood to prevent it from turning.
- 2) Loosen the flywheel bolts a little at a time in the numerical order shown in the illustration.

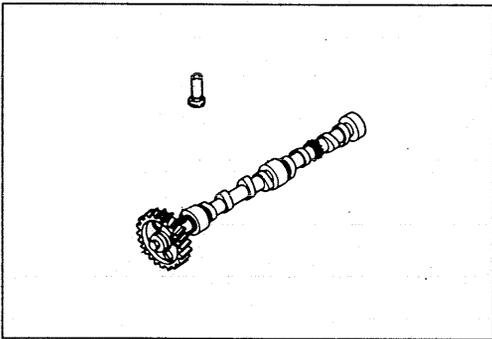

6. Camshaft with Camshaft Timing Gear and Thrust Plate

- 1) Remove the thrust plate bolts.
- 2) Pull the camshaft free along with the camshaft timing gear and the thrust plate.

Note:

Be careful not to damage the camshaft journal, the cam, and the camshaft during the disassembly procedure.

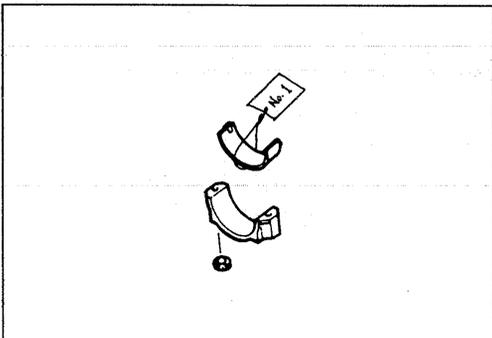

8. Connecting Rod Cap with Lower Bearing

If the connecting rod lower bearings are to be reinstalled, mark their fitting positions by tagging each bearing with the cylinder number from which it was removed.

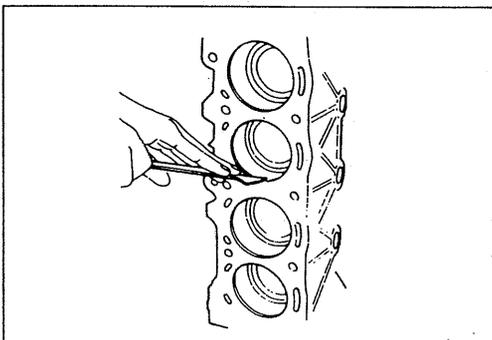

9. Piston and Connecting Rod with Upper Bearing

- 1) Remove carbon deposits from the upper portion of the cylinder wall with a scraper before removing the piston and connecting rod.
- 2) Move the piston to the top of the cylinder and tap it with a hammer grip or similar object from the connecting rod lower side to drive it out.

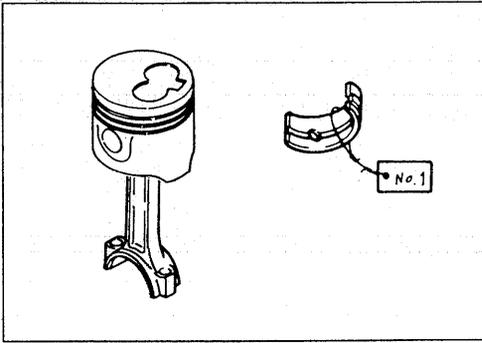

If the connecting rod upper bearings are to be reinstalled, mark their fitting positions by tagging each bearing with the cylinder number from which it was removed.

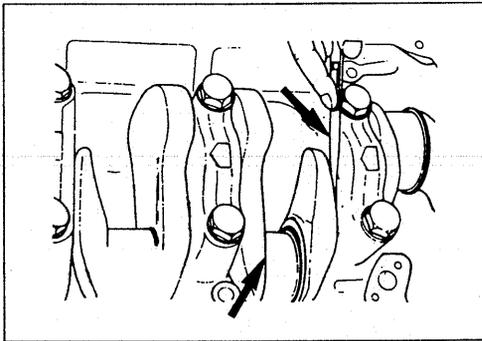

10. Crankshaft Bearing Cap with Lower Bearing

- 1) Measure the crankshaft end play at the center journal of the crankshaft.

Do this before removing the crankshaft bearing caps.

If the measured value exceeds the specified limit, the crankshaft thrust bearing must be replaced.

Crankshaft End Play		mm(in.)
Standard	Limit	
0.10 (0.004)	0.30 (0.012)	

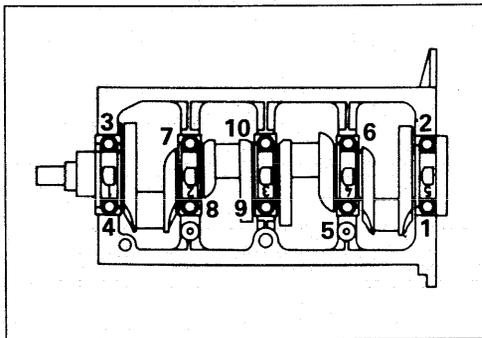

- 2) Loosen the crankshaft bearing cap bolts in numerical order a little at a time.

If the crankshaft bearings are to be reinstalled, mark their fitting positions by tagging each bearing with the cylinder number from which it was removed.

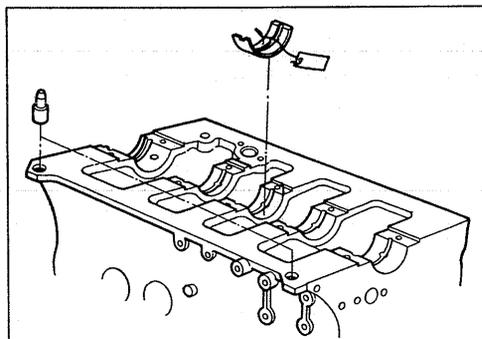

13. Crankshaft Upper Bearing

If the crankshaft upper bearings are to be reinstalled, mark their fitting positions by tagging each bearing with the cylinder number from which it was removed.

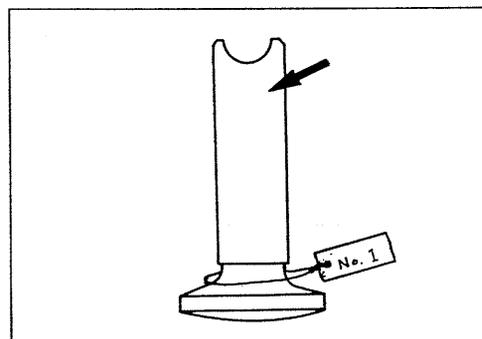

14. Tappet

If the tappets are to be reinstalled, mark their fitting positions by tagging each tappet with the cylinder number from which it was removed.

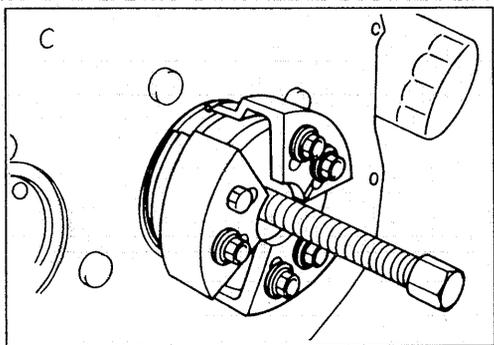

15. Rear Oil Seal

With the oil seal pushed in deep, install the special tool as shown in the illustration and remove the oil seal.

Oil Seal Remover: 5-8840-2362-0

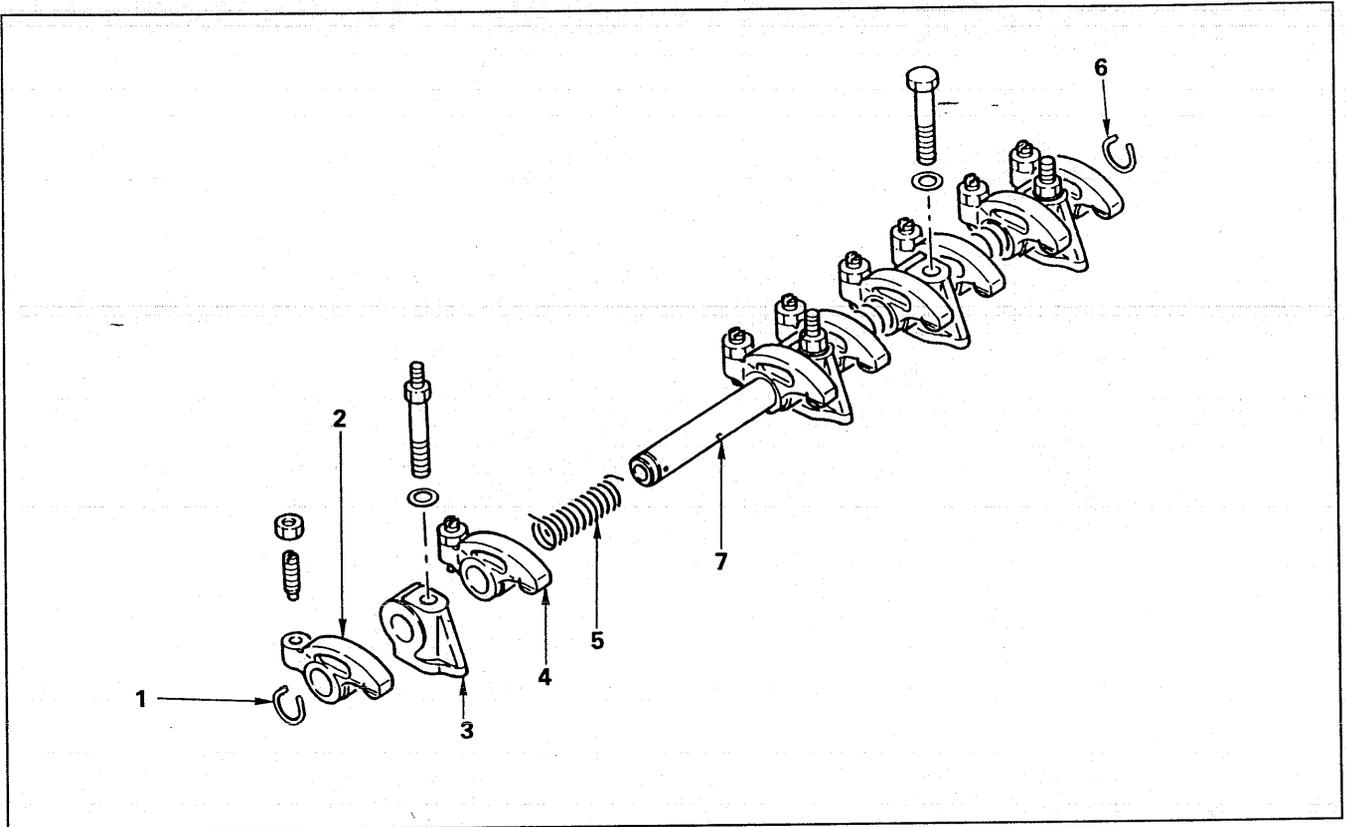
**DISASSEMBLY****SINGLE UNIT****ROCKER ARM SHAFT AND ROCKER ARM****Disassembly Steps**

- ▲ 1. Rocker arm shaft snap ring
- ▲ 2. Rocker arm
- ▲ 3. Rocker arm shaft bracket
- 4. Rocker arm
- 5. Rocker arm shaft spring
- 6. Rocker arm shaft snap ring
- 7. Rocker arm shaft



Important Operations

1. Rocker Arm Shaft Snap Ring

2. Rocker Arm

3. Rocker Arm Shaft Bracket

- 1) Use a pair of snap ring pliers to remove the snap rings.
- 2) Remove the rocker arms.
- 3) Remove the rocker arm shaft bracket.

If the rocker arms and rocker arm shaft brackets are to be reinstalled, mark their installation positions by tagging each rocker arm and rocker arm shaft bracket with the cylinder number from which it was removed.

CYLINDER HEAD

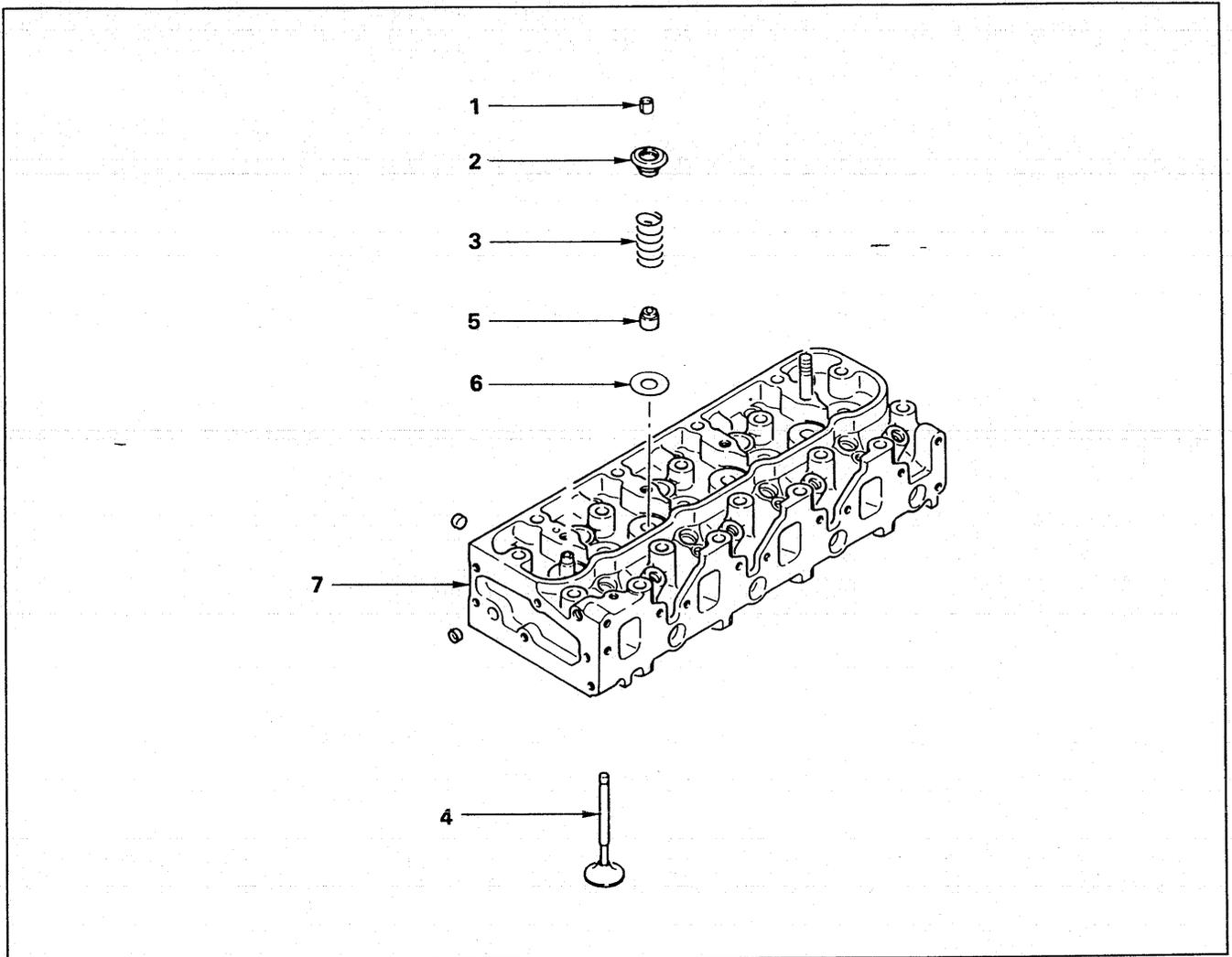
**Disassembly Steps**

- ▲ 1. Split collar
- 2. Valve spring upper seat
- 3. Valve spring
- ▲ 4. Intake and exhaust valves
- 5. Valve stem oil seal
- 6. Valve spring lower seat
- 7. Cylinder head



Important Operations

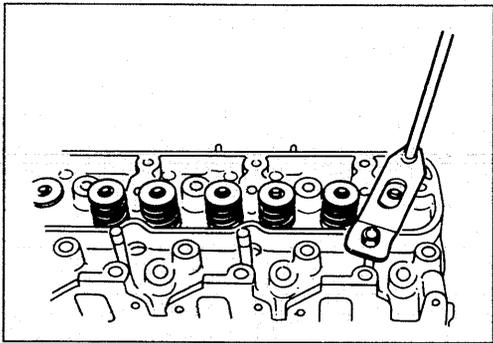

1. Split Collar

- 1) Place the cylinder head on a flat wooden surface.
- 2) Use the spring compressor to remove the split collar.

Do not allow the valve to fall from the cylinder head.

Spring Compressor: 9-8523-1423-0

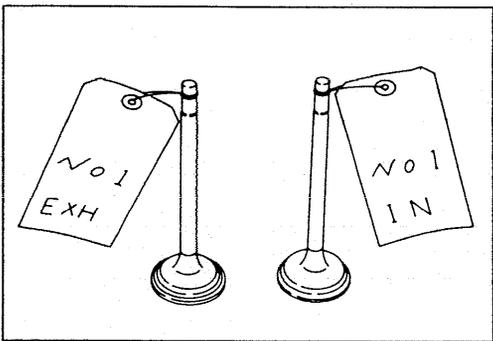

4. Intake and Exhaust Valve

If the intake and exhaust valves are to be reinstalled, mark their installation positions by tagging each valve with the cylinder number from which it was removed.

If there is excessive valve wear or damage, the valve must be replaced.

Refer to Page 54 of "Inspection and Repair" for the valve and valve seat insert procedure.

Note:

If there is excessive valve guide wear or damage, the valve guide must be replaced.

Refer to Page 53 of "Inspection and Repair" for the valve guide replacement procedure.

The valve and the valve guides must be replaced as a set. Never replace only one or the other.

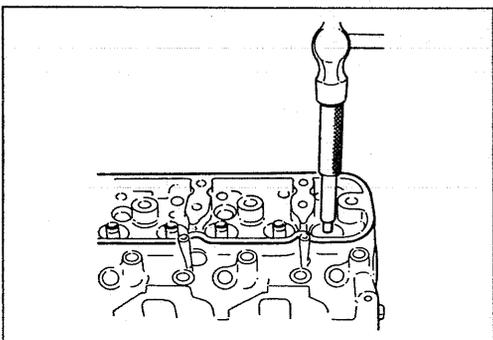

PISTON AND CONNECTING ROD

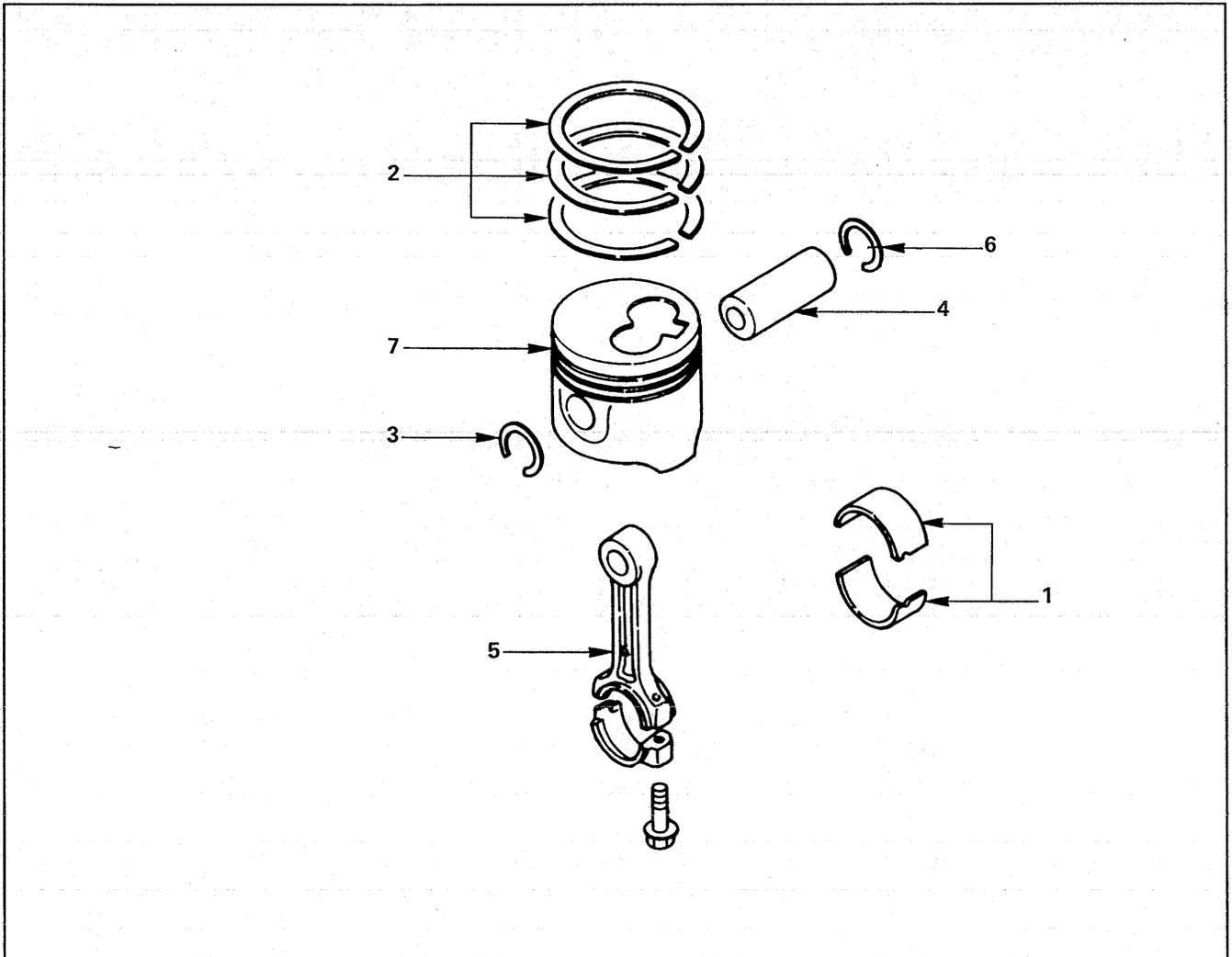
**Disassembly Steps**

- ▲ 1. Connecting rod bearing
- ▲ 2. Piston ring
- ▲ 3. Piston pin snap ring
- ▲ 4. Piston pin
- ▲ 5. Connecting rod
- ▲ 6. Piston pin snap ring
- ▲ 7. Piston



Important Operations

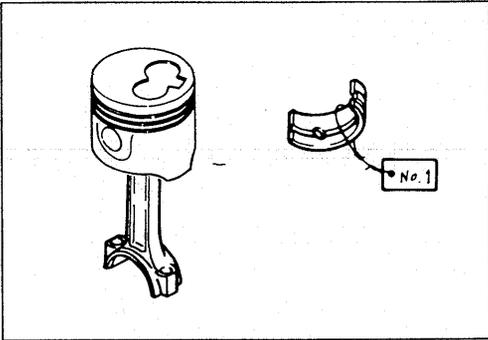

1. Connecting Rod Bearing

If the connecting rod bearings are to be reinstalled, mark their fitting positions by tagging each bearing with the cylinder number from which it was removed.

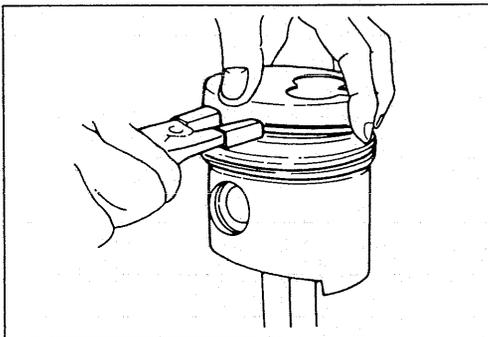

2. Piston Ring

- 1) Clamp the connecting rod in a vise.
Take care not to damage the connecting rod.
- 2) Use a piston pin replacer to remove the piston rings.



Piston Ring Replacer

Do not attempt to use some other tool to remove the piston rings. Piston ring stretching will result in reduced piston ring tension.

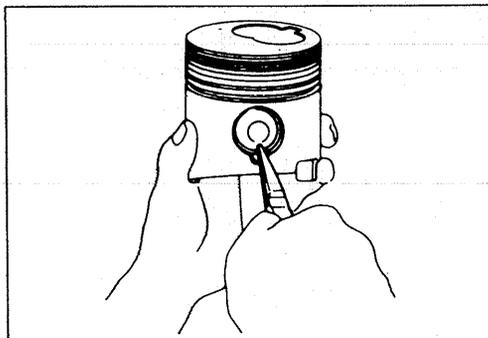

3. Piston Pin Snap Ring

4. Piston Pin

Use a pair of snap ring pliers to remove the piston pin snap rings.

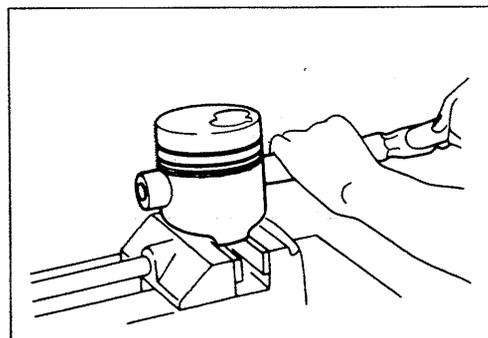

5. Connecting Rod

7. Piston

Tap the piston pin out with a hammer and a brass bar.

If the pistons are to be reinstalled, mark their installation positions by tagging each piston with the cylinder number from which it was removed.

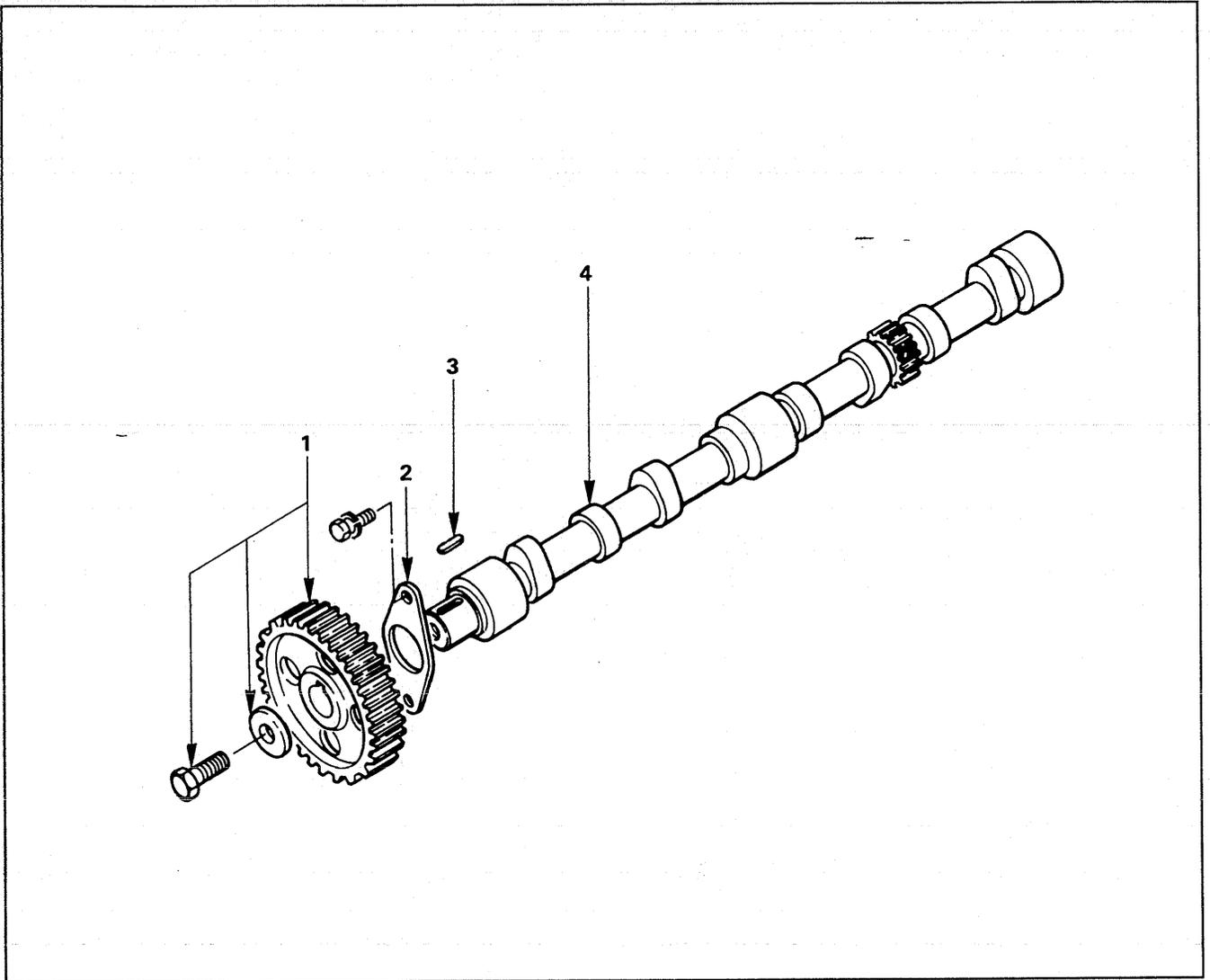
CAMSHAFT, CAMSHAFT TIMING GEAR, AND THRUST PLATE**Disassembly Steps**

- ▲ 1. Camshaft timing gear
- ▲ 2. Thrust plate

- 3. Feather key
- 4. Camshaft



Important Operations

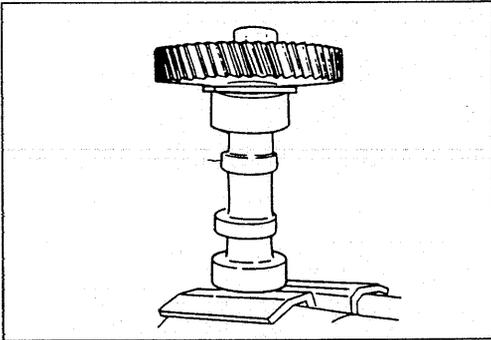

1. Camshaft Timing Gear

2. Thrust Plate

- 1) Clamp the camshaft in a vise.
Take care not to damage the camshaft.

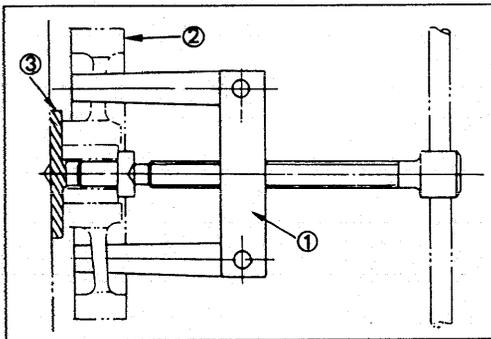

- 2) Use the universal puller ① to pull out the camshaft timing gear ② .
Universal Puller: 5-8840-0086-0
- 3) Remove the thrust plate ③ .

SECTION 4

ENGINE ASSEMBLY (2)

TABLE OF CONTENTS

ITEM	PAGE
Inspection and repair	50



INSPECTION AND REPAIR

Make the necessary adjustments, repairs, and part replacements if excessive wear or damage is discovered during inspection.

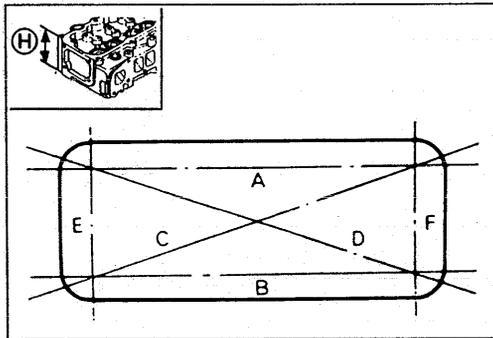
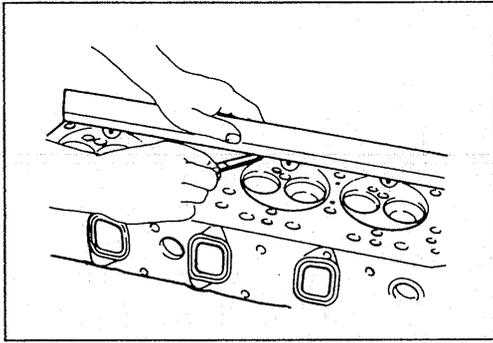

CYLINDER HEAD

Cylinder Head Lower Face Warp



1. Use a straight edge and a feeler gauge to measure the four sides and the two diagonals of the cylinder head lower face.
2. Regrind the cylinder head lower face if the measured values are greater than the specified limit but less than the maximum grinding allowance.

If the measured values exceed the maximum grinding allowance, the cylinder head must be replaced.

Cylinder Head Lower Face Warp mm(in)

Standard	Limit	Maximum Grinding Allowance
0.05 (0.002) or less	0.2 (0.008)	0.3 (0.012)

Cylinder Head Height (Reference) mm(in)

Standard	Limit
91.95 (3.620) – 92.05 (3.624)	91.65 (3.60)

Note:

If the cylinder head lower-face is reground, valve depression must be checked.

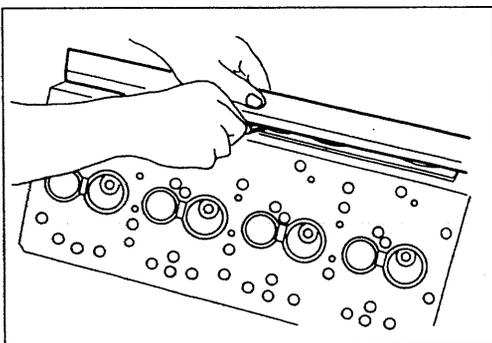

Exhaust Manifold Fitting Face Warp

Use a straight edge and a feeler gauge to measure the manifold cylinder head fitting face warp.

Regrind the manifold cylinder head fitting faces if the measured values are greater than the specified limit but less than the maximum grinding allowance.

If the measured values exceed the maximum grinding allowance, the cylinder head must be replaced.

Manifold Fitting Face Warpage mm (in)

Standard	Limit	Maximum Grinding Allowance
0.05 (0.002) or less	0.2 (0.008)	0.4 (0.016)

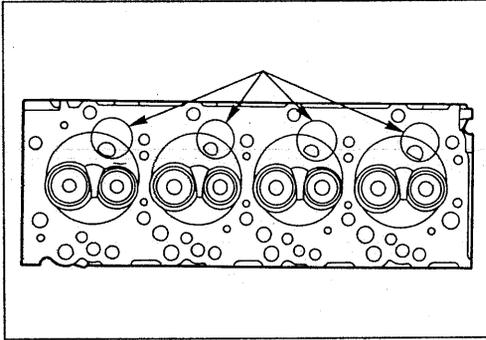

HOT PLUG

Hot plug depression

1. Clean the cylinder head lower side, taking care not to damage the hot plug surfaces.
2. Use a straight edge and feeler gauge to measure hot plug depression in a straight line from the No. 1 hot plug to the No. 4 hot plug.

If the measured value exceeds the limit, the hot plugs must be replaced.

Depression Limit mm (in)

0.02 (0.0008)

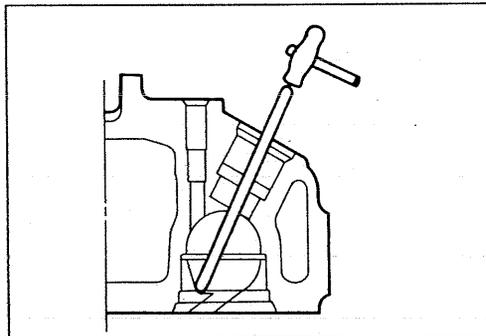

Hot plug removal

1. Insert a 3.0 – 5.0 (0.12 – 0.20 in.) diameter bar into the nozzle holder fitting hole until it makes contact with the hot plug.
2. Lightly tap the bar with a hammer to drive the hot plug free.

If the measured value exceeds the limit, the hot plugs must be replaced.

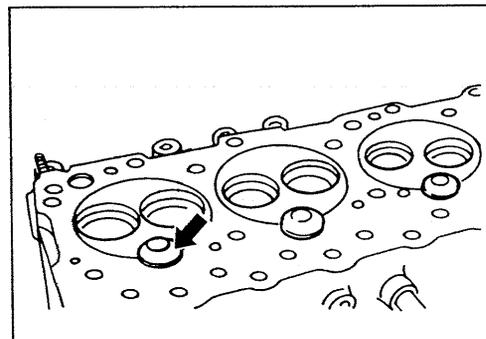

Combustion chamber inspection

1. Remove the carbon adhering to the inside of the combustion chamber. Take care not to damage the hot plug fitting positions.
2. Inspect the inside of the combustion chamber, the hot plug hole, and the hot plug machined faces for cracking and other damage.

If cracking or damage is present, the cylinder head must be replaced.

Note:

Be absolutely certain that there are not scratches or protuberance on the combustion chamber surfaces which will be in contact with the hot plug after it is installed. These flaws will prevent the hot plug from seating correctly.

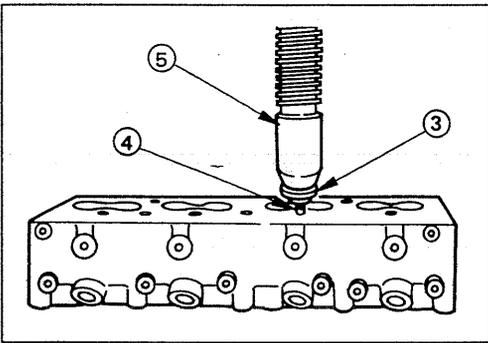
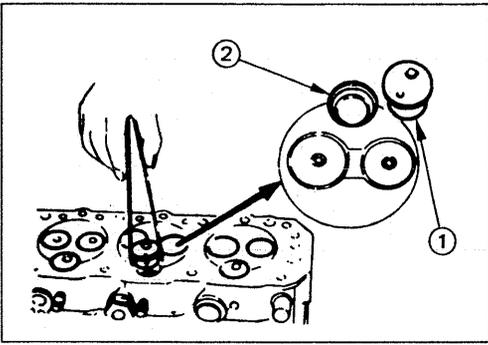

Hot plug installation

Inspect the hot plugs for excessive wear and other damage. Replace the hot plugs if either of these conditions are discovered.

1. Align the hot plug knock ball ① with the cylinder head groove ② and tap it temporarily into position with a plastic hammer.
2. Place an appropriate metal plate ③ thick over the hot plug upper surface ④.
3. Use a press ⑤ to exert a pressure of 44000 – 54000N (4500 – 5500 kg) (9923 – 12128 lbs.) on the metal plate covering the hot plug upper surface. This will drive the hot plug into position.
4. Lightly tap the hot plug heads to make sure that they are firmly seated.
5. Repeat the procedure Steps 1–4 for the remaining hot plugs.



CAUTION:

Do not apply pressure greater than that specified. Damage to the cylinder head will result.

6. Use a surface grinder to grind off any hot plug surface protuberances. The hot plug surfaces must be perfectly flush with the cylinder head.
7. After grinding, make sure that the hot plug surfaces are completely free of protuberances. The hot plug surfaces must also be free of depressions.

Once again, lightly tap the hot plug heads to make sure that they are firmly seated.

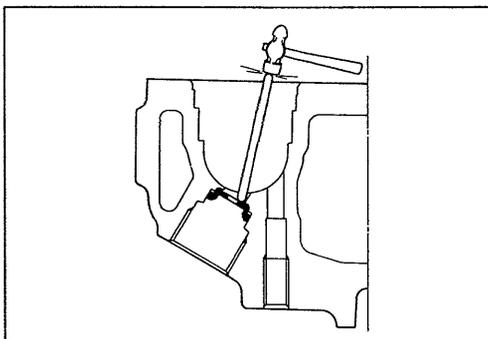
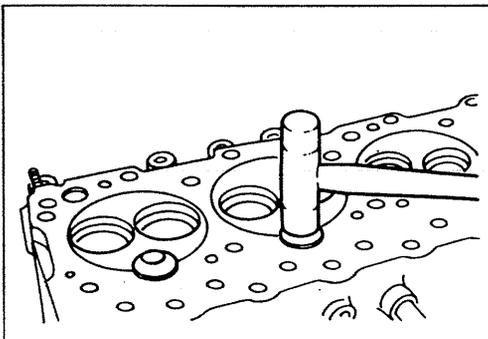

Heat shield removal

After removing the hot plugs, use a hammer ① and a brass bar ② to lightly tap the lower side of the seat shield ③ and drive it free.

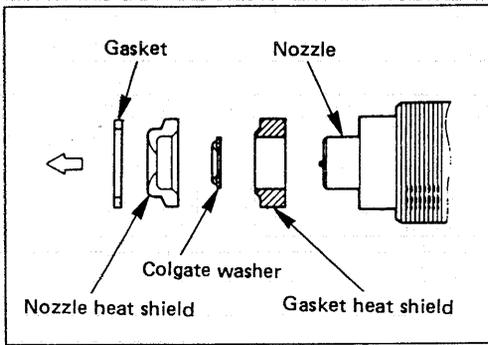

Heat shield installation

Install the heat shield washer and the heat shield to the cylinder head from the nozzle holder installation hole side. Lightly tap the flange into place with a brass bar.

The heat shield flange side must be facing up.

NOTE:

Always install a new heat shield. Never reuse the old heat shield.

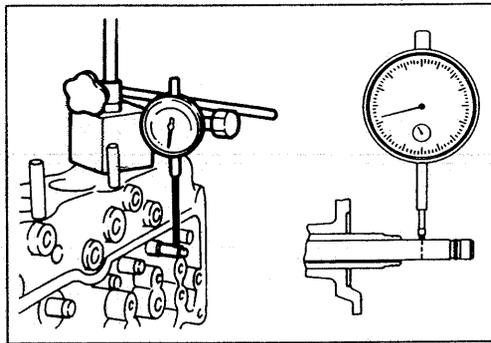

VALVE GUIDE



Valve Stem and Valve Guide Clearance

Measuring Method - I

1. With the valve stem inserted in the valve guide, set the dial indicator needle to "0".

2. Move the valve head from side to side.

Read the dial indicator.

Note the highest dial indication.

If the measured values exceed the specified limit, the valve and the valve guide must be replaced as a set.

Valve Stem Clearance

mm(in)

	Standard	Limit
Intake Valve	0.039 – 0.071 (0.0015 – 0.0028)	0.20 (0.008)
Exhaust Valve	0.064 – 0.096 (0.0025 – 0.0038)	0.25 (0.0098)

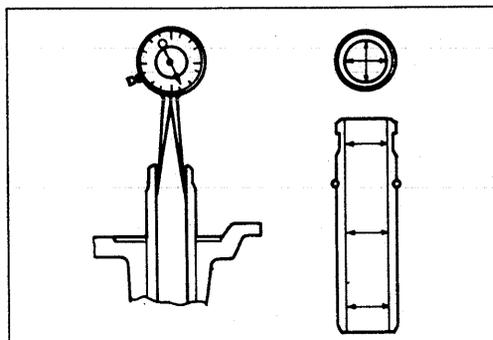

Measuring Method - II



1. Measure the valve stem outside diameter.

Refer to the Item "Valve Stem Outside Diameter".

2. Use a caliper calibrator or a telescoping gauge to measure the valve guide inside diameter.

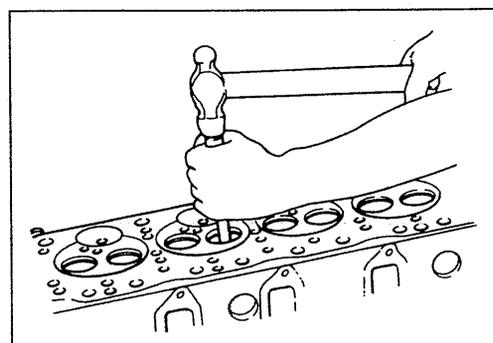

Valve Guide Replacement



Valve Guide Removal

Use a hammer and the valve guide replacer to drive out the valve guide from the cylinder head lower face.



Valve Guide Replacer: 9-8523-1212-0

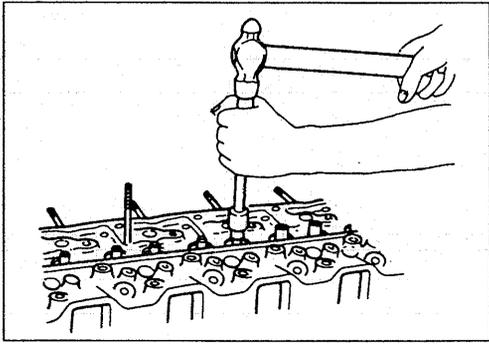

Valve Guide Installation

1. Apply engine oil to the valve guide outer circumference.
2. Attach the valve guide replacer to the valve guide.
3. Use a hammer to drive the valve guide into position from the cylinder head upper face.

Valve Guide Replacer: 9-8523-1212-0



4. Measure the height of the valve guide upper end from the upper face of the cylinder head.

Valve Guide Upper End Height (H)

(Reference)

mm(in)

13.0 (0.51)

Note:

If the valve guide has been removed, both the valve and the valve guide must be replaced as a set.

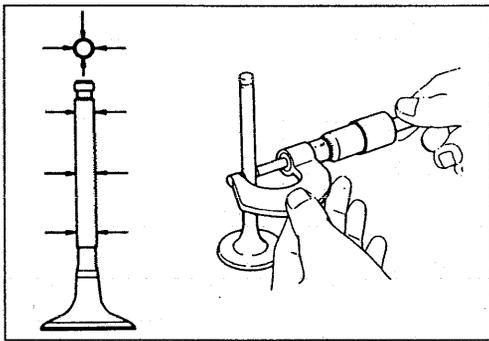
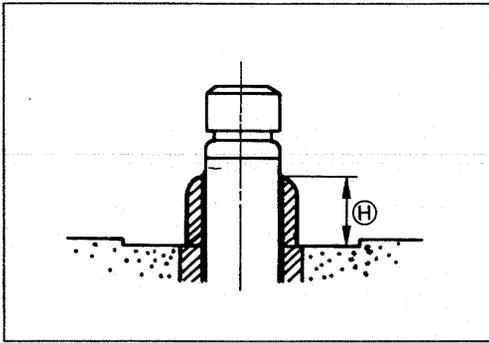

VALVE AND VALVE SEAT INSERT

Valve Stem Outside Diameter

Measure the valve stem diameter at three points.

If the measured value is less than the specified limit, the valve and the valve guide must be replaced as a set.

Valve Stem Outside Diameter

mm(in)

	Standard	Limit
Intake Valve	7.946 – 7.961 (0.3128 – 0.3134)	7.88 (0.3102)
Exhaust Valve	7.921 – 7.936 (0.3118 – 0.3124)	7.850 (0.3099)

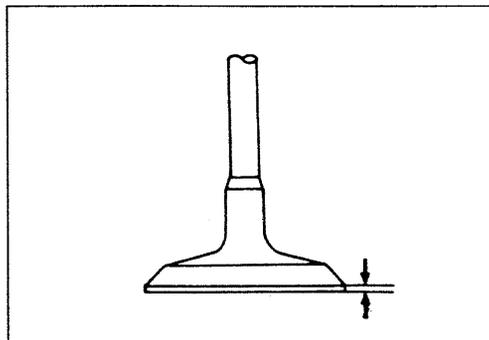

Valve Thickness

Measure the valve thickness

If the measured value is less than the specified limit, the valve and the valve guide must be replaced as a set.

Intake and Exhaust Valve Thickness

mm(in)

	Standard	Limit
Inlet	1.41	1.1 (0.043)
Exhaust	1.39	1.1 (0.043)

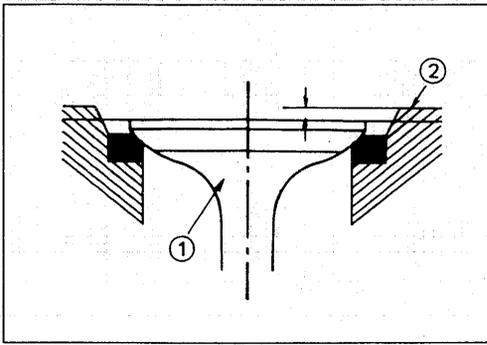

Valve Depression

1. Install the valve ① to the cylinder head ② .
2. Use a depth gauge or a straight edge with steel rule to measure the valve depression from the cylinder head lower surface.

If the measured value exceeds the specified limit, the valve seat insert must be replaced.

Valve Depression mm(in)

	Standard	Limit
Intake	0.73 (0.029)	1.28 (0.050)
Exhaust	0.70 (0.028)	1.20 (0.047)

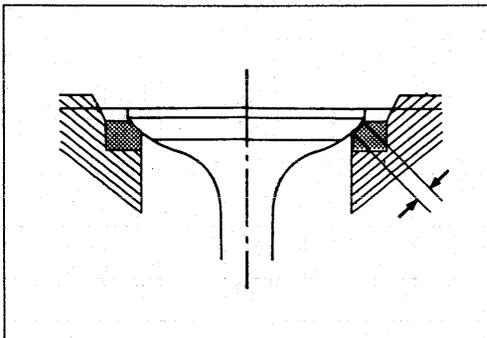

Valve Contact Width

1. Check the valve contact faces for roughness and unevenness.

Make smooth the valve contact surfaces.

2. Measure the valve contact width.

If the measured value exceeds the specified limit, the valve seat insert must be replaced.

Valve Contact Width mm(in)

	Standard	Limit
Intake	1.7 (0.067)	2.2 (0.087)
Exhaust	2.0 (0.079)	2.5 (0.078)

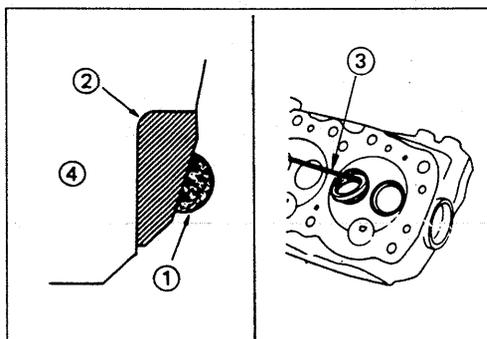

Valve Seat Insert Replacement

Valve Seat Insert Removal

1. Arc weld the entire inside circumference ① of the valve seat insert ②.
2. Allow the valve seat insert to cool for a few minutes. This will invite contraction and make removal of the valve seat insert easier.

- Use a screwdriver ③ to pry the valve seat insert free.

Take care not to damage the cylinder head ④ .



- Carefully remove carbon and other foreign material from the cylinder head insert bore.

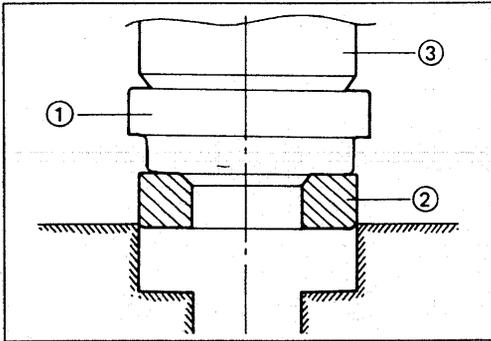

Valve Seat Insert Installation

- Carefully place the attachment ① (having a smaller outside diameter than the valve seat insert) on the valve seat insert ② .

Note:

The smooth side of the attachment must contact the valve seat insert.

- Use a bench press ③ to gradually apply pressure to the attachment and press the valve seat insert into place.

Note:

Do not apply an excessive amount of pressure with the bench press. Damage to the valve seat insert will result.

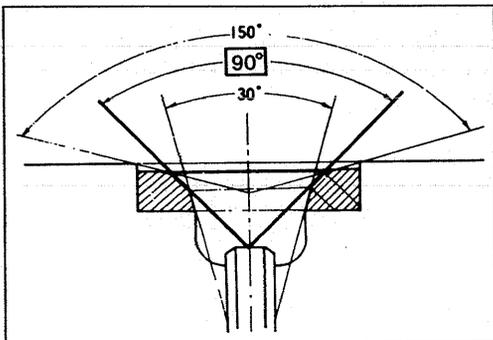

Valve Seat Insert Correction

- Remove the carbon from the valve seat insert surface.
- Use a valve cutter (15°, 45°, and 75° blades) to minimize scratches and other rough areas. This will bring the contact width back to the standard value.

Remove only the scratches and rough areas. Do not cut away too much. Take care not to cut away unblemished areas of the valve seat surface.

Valve Seat Angle	45°
------------------	-----

Note:



Use an adjustable valve cutter pilot.

Do not allow the valve cutter pilot to wobble inside the valve guide.

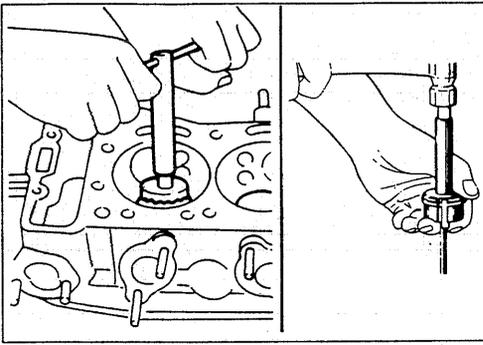

3. Apply abrasive compound to the valve seat insert surface.
4. Insert the valve into the valve guide.
5. Turn the valve while tapping it to fit the valve seat insert.
6. Check that the valve contact width is correct.
7. Check that the valve seat insert surface is in contact with the entire circumference of the valve.

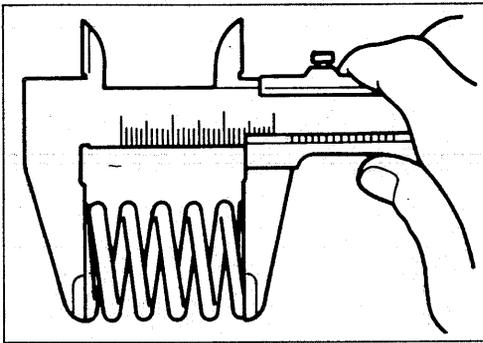

VALVE SPRING

Valve Spring Free Height



Use a vernier caliper to measure the valve spring free height.

If the measured value is less than the specified limit, the valve spring must be replaced.

Valve Spring Free Height mm(in)

Standard	Limit
49.7 (1.96)	48.2 (1.90)

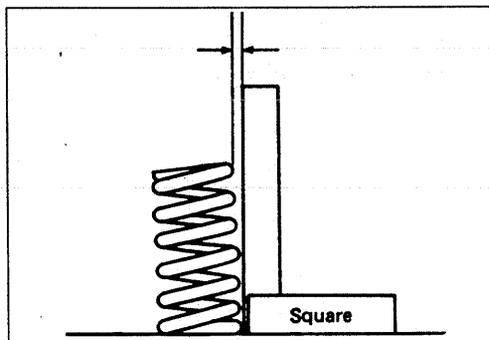

Valve Spring Inclination



Use a surface plate and a square to measure the valve spring inclination.

If the measured value exceeds the specified limit, the valve spring must be replaced.

Valve Spring Inclination mm(in)

Standard	Limit
1.5 (0.06) or less	2.5 (0.984) or more

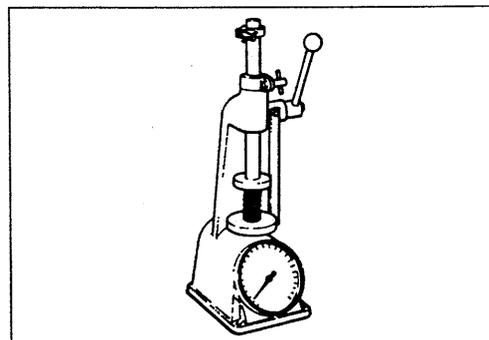

Valve Spring Tension



Use a spring tester to measure the valve spring tension.

If the measured value is less than the specified limit, the valve spring must be replaced.

Valve Spring Tension kg(lb)

Compressed Height	Standard	Limit
38.9 mm (1.53 in)	32.6 (71.7)	29.0 (63.8)

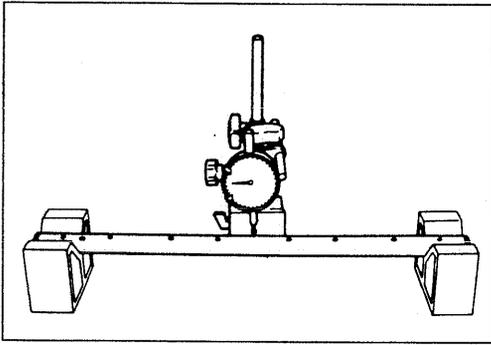

ROCKER ARM SHAFT AND ROCKER ARM

Rocker Arm Shaft Run-Out

1. Place the rocker arm shaft on a V-block.
2. Use a dial indicator to measure the rocker arm shaft central portion run-out.

If the run-out is very slight, correct the rocker arm shaft run-out with a bench press. The rocker arm must be at cold condition.

If the measured rocker arm shaft run-out exceeds the specified limit, the rocker arm shaft must be replaced.

Rocker Arm Shaft Run-Out mm(in)

Standard	Limit
0.2 (0.008)	0.6 (0.024)

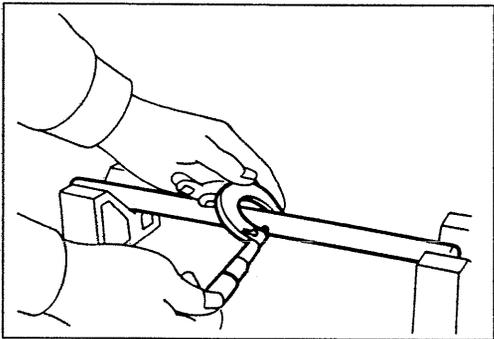

Rocker Arm Shaft Outside Diameter

Use a micrometer to measure the rocker arm fitting portion outside diameter.

If the measured value is less than the specified limit, the rocker arm shaft must be replaced.

Rocker Arm Shaft Outside Diameter mm(in)

Standard	Limit
18.98 – 19.00 (0.747 – 0.748)	18.85 (0.742)

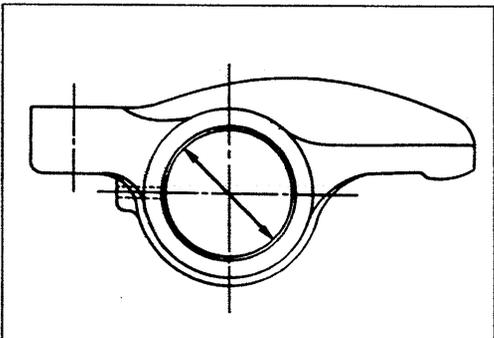

Rocker Arm Shaft and Rocker Arm Clearance

1. Use either a vernier caliper or a dial indicator to measure the rocker arm bushing inside diameter.

Rocker Arm Bushing Inside Diameter mm(in)

Standard	Limit
19.01 – 19.03 (0.748 – 0.749)	19.05 (0.750)



2. Measure the rocker arm shaft outside diameter.

If the measured value exceeds the specified limit, replace either the rocker arm or the rocker arm shaft.

Rocker Arm and Rocker Arm Shaft Clearance mm(in)

Standard	Limit
0.01 – 0.05 (0.0004 – 0.002)	0.2 (0.008)

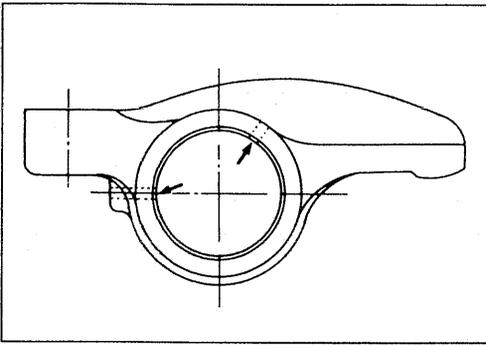

3. Check that the rocker arm oil port is free of obstructions.

If necessary, use compressed air to clean the rocker arm oil port.

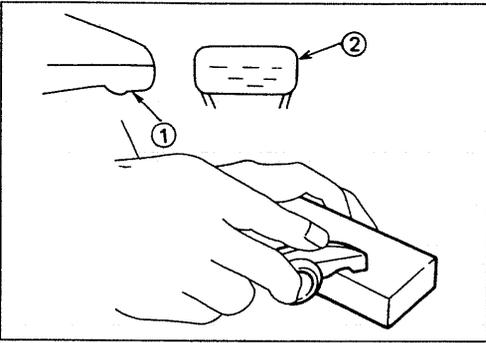

Rocker Arm Correction

Inspect the rocker arm valve stem contact surfaces for step wear (1) and scoring (2).

If the contact surfaces have light step wear or scoring, they may be honed with an oil stone.

If the step wear or scoring is severe, the rocker arm must be replaced.

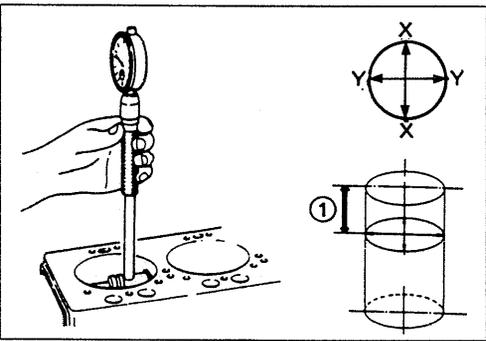

CYLINDER BODY

Cylinder Liner Bore Measurement



Use a cylinder indicator to measure the cylinder bore at measuring point (1) in the thrust X - X and axial Y - Y directions of the crankshaft.

Measuring Point (1) : Maximum wear portion

[11 ~ 15 mm (0.43 ~ 0.59 in)]

If the measured value exceeds the specified limit, the cylinder liner must be replaced.

Cylinder Liner Bore mm(in)

Standard	Limit
95.421 – 95.460 (3.7567 – 3.7583)	95.5 (3.7598)

Note:

The inside of the dry type cylinder liner is chrome plated. It cannot be rebored or honed.

If the inside of the cylinder liner is scored or scorched, the cylinder liner must be replaced.

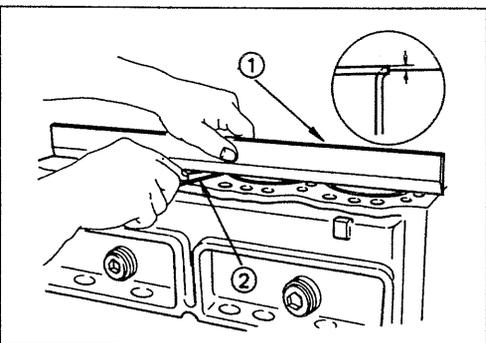

Cylinder Liner Projection Inspection

1. Hold a straight edge (1) along the top edge of the cylinder liner to be measured.

2. Use a feeler gauge (2) to measure each cylinder liner projection.



Cylinder Liner Projection mm(in)

Standard
0 – 0.10 (0 – 0.004)

The difference in the cylinder liner projection height between any two adjacent cylinders must not exceed 0.03 mm (0.0012 in).

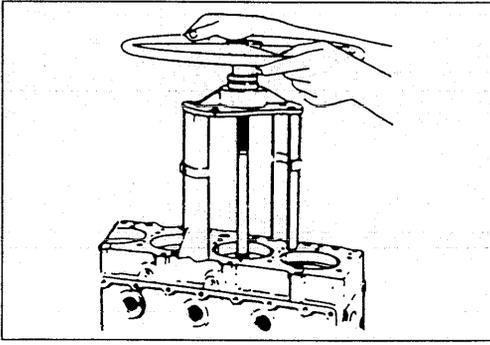

Cylinder Liner Replacement

Cylinder Liner Removal



1. Remove the cylinder body dowel.
2. Set the cylinder liner remover to the cylinder liner.
3. Check that the remover shaft ankle is firmly gripping the cylinder liner bottom edge.
4. Slowly turn the remover shaft handle counterclockwise to pull the cylinder liner free.



Cylinder Liner Remover Ankle: 5-8840-2304-0

Cylinder Liner Remover: 9-8523-1169-0

NOTE:

Take care not to damage the cylinder body upper during the cylinder liner removal procedure.

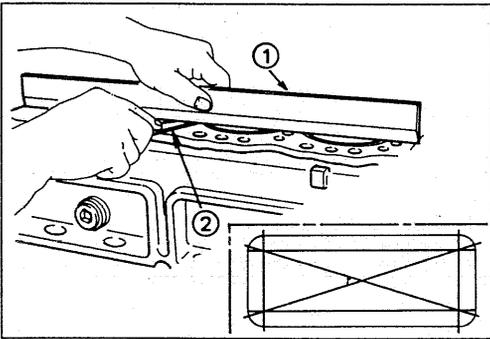

Cylinder Body Upper Face Warpage



Use a straight edge ① and a feeler gauge ② to measure the four sides and the two diagonals of the cylinder body upper face.

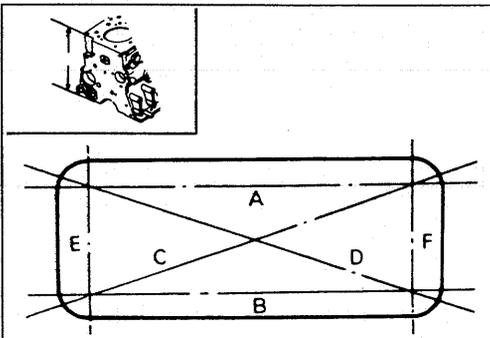

Cylinder Body Upper Face Warpage mm(in)

Standard	Limit
0.05 (0.002) or less	0.2 (0.008)

If the measured value is more than the limit, the cylinder body must be replaced.

Cylinder Body Height (Reference) mm(in)

Standard
272.945 – 273.105 (10.7458 – 10.7521)

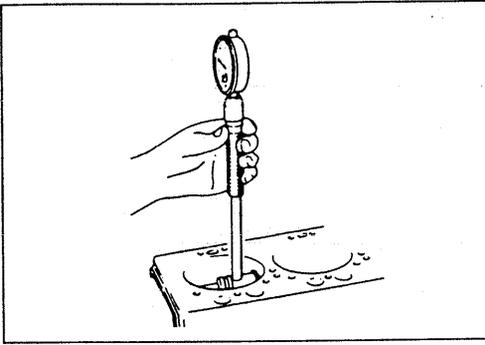

Cylinder Liner Grade Selection

Measure the cylinder body inside diameter and select the appropriate cylinder liner grade.

Standard Fitting Interference	mm(in)
0.001 – 0.019 (0.0004 – 0.00075)	

If the cylinder liner fitting interference is too small, engine cooling efficiency will be adversely affected.

If the cylinder liner fitting interference is too large, it will be difficult to insert the cylinder liner into the cylinder body.

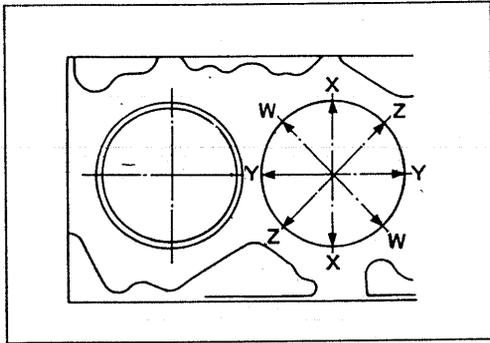

1. Take measurements at measuring point ① across positions ("W – W"), ("X – X"), (Y – Y) and (Z – Z).

Measuring Point ① : 88 mm (3.46 in)

2. Calculate the average value of the four measurements to determine the correct cylinder grade.

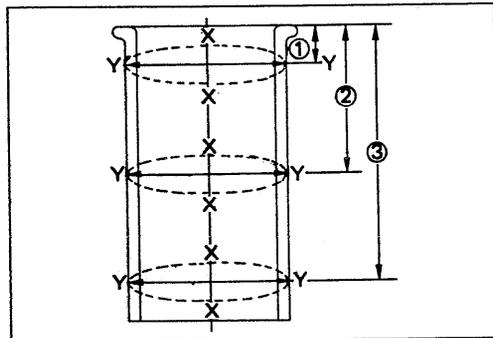

Cylinder Liner Outside Diameter Measurement

1. Take two measurements each at measuring points ①, ②, and ③.

Measuring Point ① : 20 mm (0.79 in)

Measuring Point ② : 50 mm (1.97 in)

Measuring Point ③ : 150 mm (5.90 in)



2. Calculate the average value of the six measurements to determine the correct cylinder liner grade.



Cylinder Liner Installation



1. Cylinder Liner Installation Using The Special Tool.

- 1) Use new kerosene or diesel oil to thoroughly clean the cylinder liners and bores.
- 2) Use compressed air to blow-dry the cylinder liner and bore surfaces.

Note:

All foreign material must be carefully removed from the cylinder liner and the cylinder bore before installation.

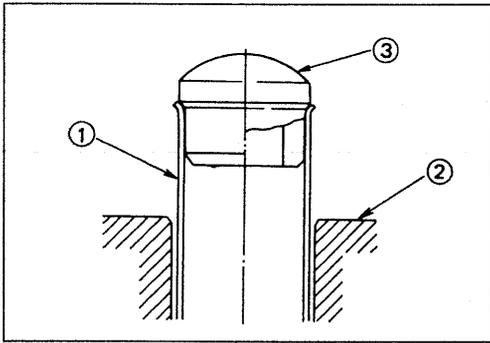

- 3) Insert the cylinder liner ① into the cylinder body ② from the top of the cylinder body.

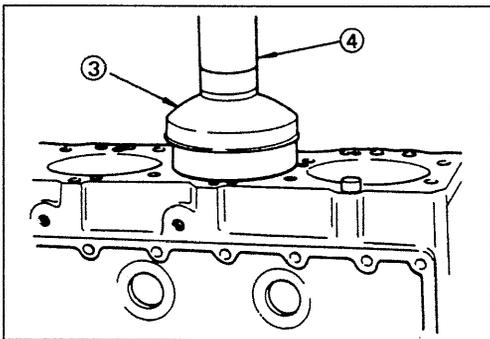

- 4) Set the cylinder liner installer ③ to the top of the cylinder liner.

Cylinder Liner Installer: 5-8840-2313-0

- 5) Position the cylinder body so that the installer center ③ is directly beneath the bench press shaft center ④.

Note:

Check that the cylinder liner is set perpendicular to the bench press and that there is no wobble.

- 6) Use the bench press to apply a seating force of 500 kg (1,102.5 lb/4,900 N) to the cylinder liner.
- 7) Apply a force of 2,500 kg (5,512.5 lb/24,500 N) to fully seat the cylinder liner.
- 8) After installing the cylinder liner, measure the cylinder liner projection.

Refer to "Cylinder Liner Projection Inspection".



2. Cylinder Liner Installation Using Dry Ice

If the cylinder liner is a chrome plated dry type, it is advisable to use dry ice during the installation procedure.

Cooling the cylinder liner with dry ice will cause the cylinder liner to contract, thus making installation easier.

Note:

It is important that the cylinder liner be inserted to the cylinder body immediately after it has been cooled.

WARNING:

DRY ICE MUST BE USED WITH GREAT CARE. CARELESS HANDLING OF DRY ICE CAN RESULT IN SEVERE FROSTBITE.

Cylinder Bore and Cylinder Liner Outside Diameter Combination (Reference)

mm(in)

	Cylinder Bore	Cylinder Liner Outside Diameter
1	97.001 – 97.010 (3.8189 – 3.8193)	97.011 – 97.020 (3.8193 – 3.8197)
2	97.011 – 97.020 (3.8193 – 3.8197)	97.021 – 97.030 (3.8197 – 3.8201)
3	97.021 – 97.030 (3.8197 – 3.8201)	97.031 – 97.040 (3.8201 – 3.8205)
4	97.031 – 97.040	97.041 – 97.050

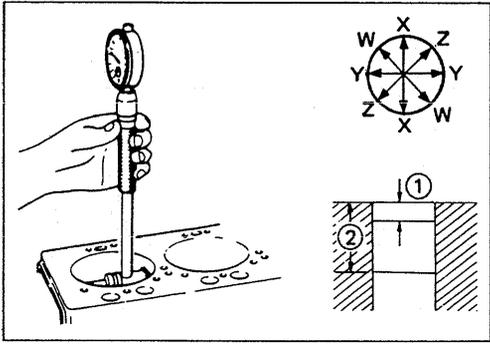

Piston Grade Selection



Measure the cylinder liner bore after installing the cylinder liner. Then select the appropriate piston grade for the installed cylinder liner.

1. Measure the cylinder liner bore.

There are two measuring points (① and ②).

Measure the cylinder liner bore in four different direction (W – W, X – X, and Z – Z) at both measuring points.

Calculate the average value of the eight measurements to determine the correct cylinder liner bore.

- Measuring Points ① : 20 mm (0.79 in)
 ② : 160 mm (6.30 in)

Cylinder Liner Bore		mm(in)
Standard	Limit	
95.421 – 95.460 (3.7567 – 3.7583)	95.5 (3.7598)	

Note:

It is most important that the correct piston grade be used. Failure to select the correct piston grade will result in engine failure. Always measure the cylinder bore and select the correct piston grade.

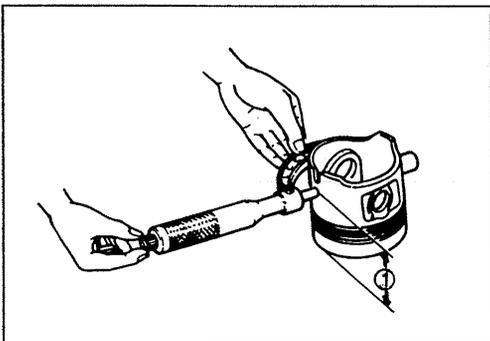

2. Measure the piston outside diameter.

Piston Measuring Point ① : 71 mm (2.80 in)

Piston Grade		mm(in)
Grade Ⓐ	Grade Ⓒ	
95.365 – 95.384 (3.7545 – 3.7553)	95.385 – 95.404 (3.7553 – 3.7561)	

Cylinder Liner and Piston Clearance	mm(in)
0.037 – 0.075 (0.0015 – 0.0030)	

Note:

Cylinder liner kit clearances are preset. However, the cylinder liner installation procedure may result in slight decreases in cylinder liner clearances. Always measure the cylinder liner clearance after installation to be sure that it is correct.

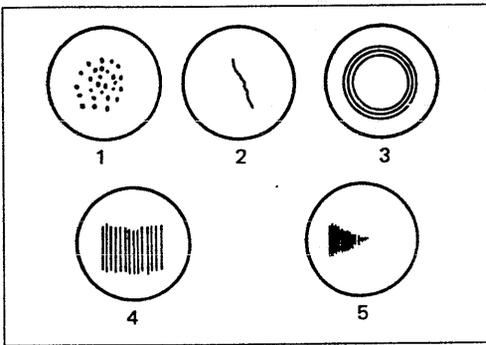

TAPPET AND PUSH ROD

Visually inspect the tappet camshaft contact surfaces for pitting, cracking, and other abnormal conditions. The tappet must be replaced if any of these conditions are present.

Refer to the illustration at the left.

- 1 Normal contact
- 2 Cracking
- 3 Pitting
- 4 Irregular contact
- 5 Irregular contact

Note:

The tappet surfaces are spherical. Do not attempt to grind them with an oil stone or similar tool in an effort to repair the tappet. If the tappet is damaged, it must be replaced.

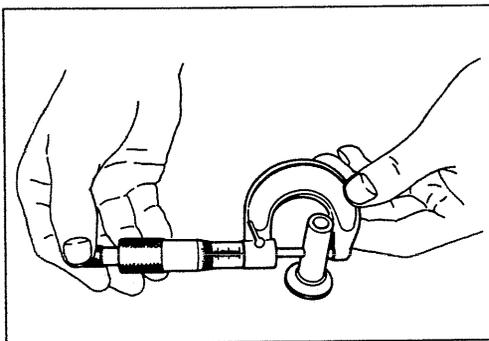

Tappet Outside Diameter

Measure the tappet outside diameter with a micrometer. If the measured value is less than the specified limit, the tappet must be replaced.

Tappet Outside Diameter		mm(in)
Standard	Limit	
12.97 – 12.99 (0.510 – 0.511)	12.95 (0.509)	

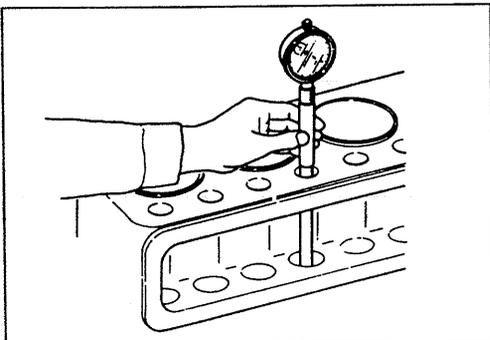

Tappet and Cylinder Body Clearance

Tappet and Cylinder Body Clearance		mm(in)
Standard	Limit	
0.03 (0.001)	0.1 (0.004)	

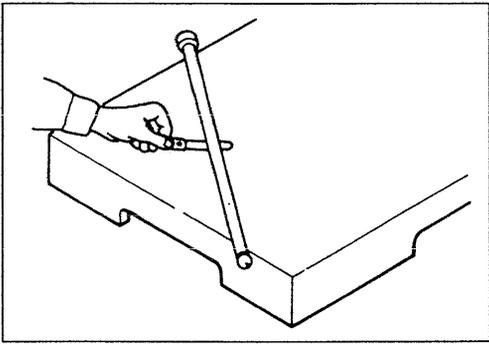

Push Rod Curvature

1. Lay the push rod on a surface plate.
2. Roll the push rod along the surface plate and measure the push rod curvature with a thickness gauge.
If the measured value exceeds the specified limit, the push rod must be replaced.

Push Rod Curvature	mm(in)
Limit	
0.3 (0.012)	

3. Visually inspect both ends of the push rod for excessive wear and damage. The push rod must be replaced if these conditions are discovered during inspection.

CAMSHAFT

Visually inspect the journals, the cams, the oil pump drive gear, and the camshaft bearings for excessive wear and damage. The camshaft and the camshaft bearings must be replaced if these conditions are discovered during inspection.

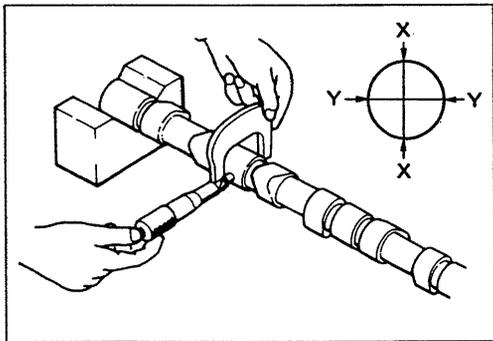

Camshaft Journal Diameter

Use a micrometer to measure each camshaft journal diameter in two directions ((X - X) and (Y - Y)). If the measured value is less than the specified limit, the camshaft must be replaced.

Camshaft Journal Diameter		mm(in)
Standard	Limit	
49.945 – 49.975 (1.966 – 1.968)	49.60 (1.953)	

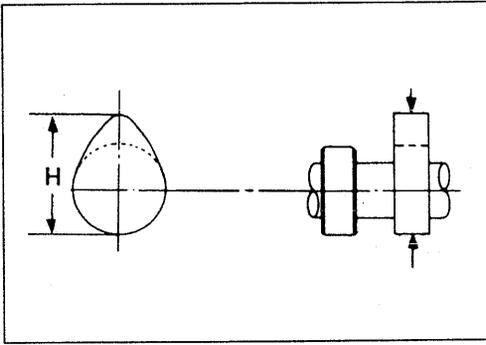

Cam Height

Measure the cam height (H) with a micrometer. If the measured value is less than the specified limit, the camshaft must be replaced.

Cam Height (H) mm(in)

Standard	Limit
42.08 (1.65)	41.65 (1.64)

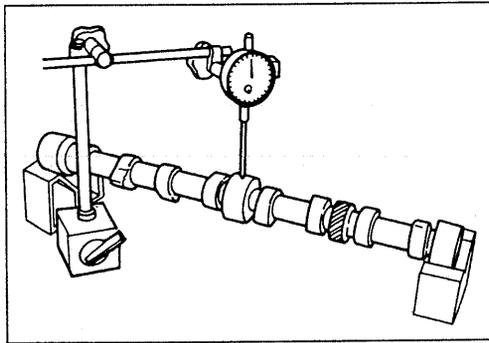

Camshaft Run-Out

1. Mount the camshaft on V-blocks.
2. Measure the run-out with a dial indicator.

If the measured value exceeds the specified limit, the camshaft must be replaced.

Camshaft Run-Out mm(in)

Standard	Limit
0.02 (0.0008)	0.10 (0.004)

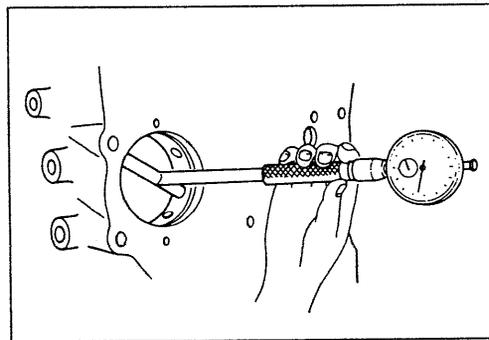

Camshaft and Camshaft Bearing Clearance

Use an inside dial indicator to measure the camshaft bearing inside diameter.

Camshaft Bearing Inside Diameter mm(in)

Standard	Limit
50.0 – 50.03 (1.9685 – 1.9696)	50.08 (1.9716)

If the clearance between the camshaft bearing inside diameter and the journal exceeds the specified limit, the camshaft bearing must be replaced.

Camshaft Bearing Clearance mm(in)

Standard	Limit
0.025 – 0.085 – (0.0010 – 0.0033)	0.12 (0.005)

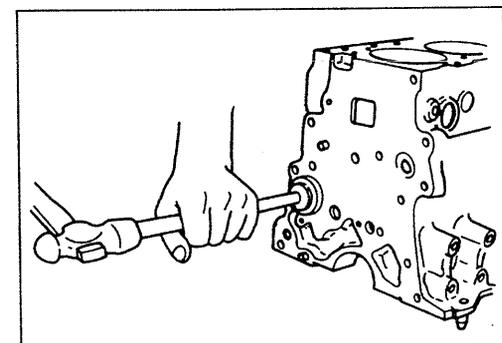

Camshaft Bearing Replacement

Camshaft Bearing Removal

1. Remove the cylinder body plug plate.
2. Use the camshaft bearing replacer to remove the camshaft bearing.



Bearing Replacer: 5-8840-2038-0

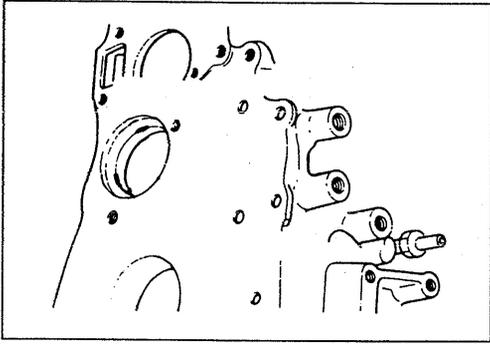

Camshaft Bearing Installation

1. Align the bearing oil holes with the cylinder body oil holes.
2. Use the camshaft bearing replacer installer to install the camshaft bearing.

Bearing Replacer: 5-8840-2038-0

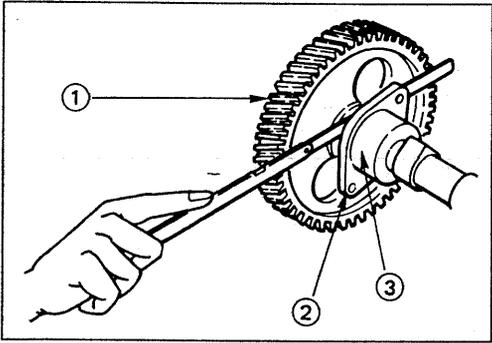

Camshaft End Play

1. Before removing the camshaft gear ①, push the thrust plate ② as far as it will go toward the camshaft gear.
2. Use a feeler gauge to measure the clearance between the thrust plate and the camshaft journal. If the measured value exceeds the specified limit, the thrust plate must be replaced.

Camshaft End Play mm(in)

Standard	Limit
0.050 – 0.114 (0.002 – 0.0044)	0.2 (0.008)

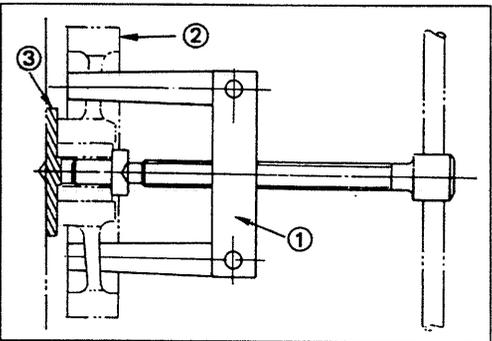

Thrust Plate Replacement

Thrust Plate Removal

1. Use the universal puller ① to remove the camshaft timing gear ②.

Universal Puller: 5-8840-0086-0

2. Remove the thrust plate ③.

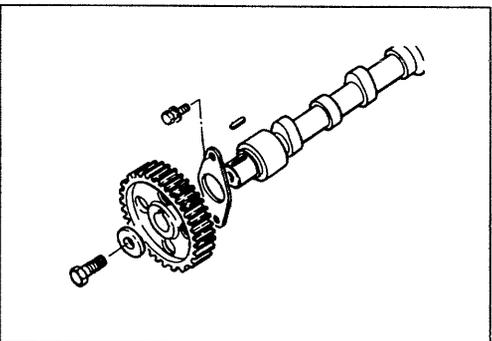

Thrust Plate Installation

1. Install the thrust plate.
2. Apply engine oil to the bolt setting face and the bolt threads.
3. Install the camshaft gear.

Camshaft Gear Torque kg·m(lb.ft/N·m)

10.0 – 12.0 (72 – 87/98 – 118)

CRANKSHAFT AND BEARING

Inspect the surface of the crankshaft journals and crankpins for excessive wear and damage.

Inspect the oil seal fitting surfaces for excessive wear and damage.

Inspect the oil ports for obstructions.

Note:

To increase crankshaft strength, tufftriding (Nitriding Treatment) has been applied. Because of this, it is not possible to grind the crankshaft surfaces.

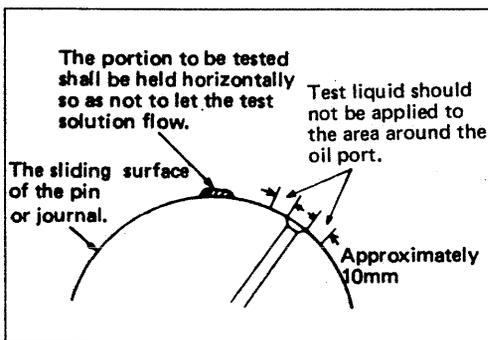

Crankshaft Tufftriding Inspection

1. Use an organic cleaner to thoroughly clean the crankshaft. There must be no traces of oil on the surfaces to be inspected.
2. Prepare a 5 – 10% solution of ammonium cuprous chloride (dissolved in distilled water).
3. Use a syringe to apply the solution to the surface to be inspected.

Hold the surface to be inspected perfectly horizontal to prevent the solution from running.

Note:

Do not allow the solution to come in contact with the oil ports and their surrounding area.

Judgement

1. Wait for thirty to forty seconds.

If there is no discoloration after thirty or forty seconds, the crankshaft is usable.

If discoloration appears (the surface being tested will become the color of copper), the crankshaft must be replaced.



2. Steam clean the crankshaft surface immediately after completing the test.

Note:

The ammonium cuprous chloride solution is highly corrosive. Because of this, it is imperative that the surfaces being tested be cleaned immediately after completing the test.

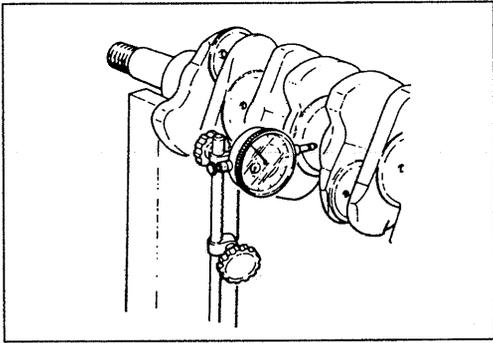

Crankshaft Run-Out

1. Set a dial indicator to the center of the crankshaft journal.
2. Gently turn the crankshaft in the normal direction of rotation. Read the dial indicator as you turn the crankshaft. If the measured value exceeds the specified limit, the crankshaft must be replaced.

Crankshaft Run-Out		mm(in)
Standard		Limit
0.05 (0.002) or less		0.08 (0.003)

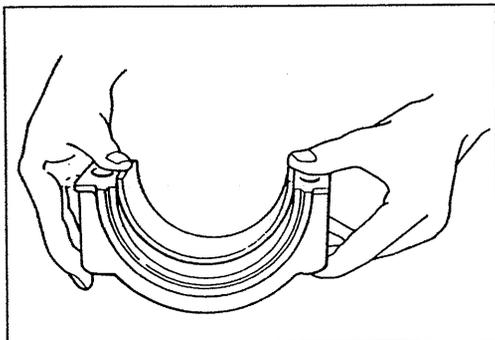

Bearing Tension

Check to see if the bearing has enough tension, so that a good finger pressure is needed to fit the bearing into position.

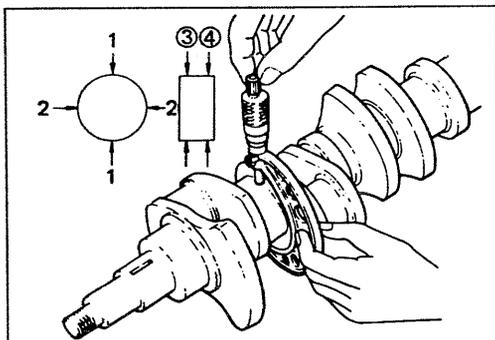

Crankshaft Journal and Crankpin Diameter

1. Use a micrometer to measure the crankshaft journal diameter across points ("1 - 1") and ("2 - 2").
2. Use the micrometer to measure the crankshaft journal diameter at the two points (③ and ④).
3. Repeat Steps 1 and 2 to measure the crankpin diameter.

If the measured values are less than the limit, the crankshaft must be replaced.

Crankshaft Journal Diameter		mm(in)
Standard	Limit	
69.917 – 69.932 (2.7526 – 2.7531)	69.910 (2.7524)	

Crankpin Diameter		mm(in)
Standard	Limit	
52.915 – 52.930 (2.0833 – 2.0839)	52.906 (2.0829)	

Crankshaft Journal and Crankpin Uneven Wear		mm(in)
Standard	Limit	
0.05 (0.002) or less	0.08 (0.003)	

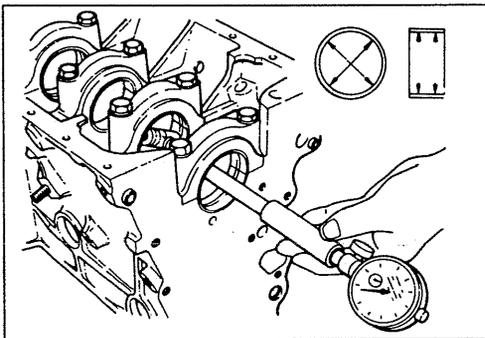

Crankshaft Journal and Bearing Clearance

If the clearance between the measured bearing inside diameter and the crankshaft journal diameter exceeds the specified limit, the bearing and/or the crankshaft must be replaced.



Crankshaft Bearing Cap Bolt Torque	kg·m(lb.ft./N·m)
	16.0 – 18.0 (116 – 130/157 – 177)

Crankshaft Journal and Bearing Clearance		mm(in)
Standard	Limit	
0.031 – 0.063 (0.0012 – 0.0025)	0.11 (0.0043)	

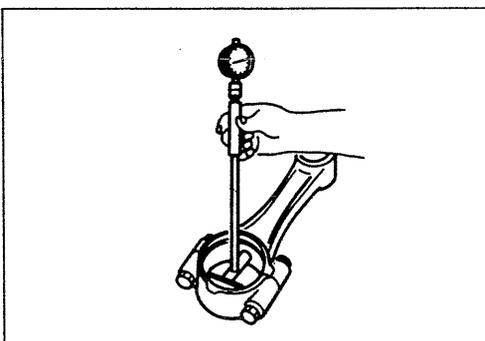

Connecting Rod Bearing Inside Diameter

1. Install the bearing to the connecting rod big end.
2. Tighten the bearing cap to the specified torque.

Connecting Rod Bearing Cap Bolt Torque	kg·m(lb.ft./N·m)
	2.8 – 3.2 → 45° – 60° (20 – 23/27 – 31)



3. Use a inside dial indicator to measure the connecting rod bearing inside diameter.



Crankpin and Bearing Clearance

If the clearance between the measured bearing inside diameter and the crankpin exceeds the specified limit, the bearing and/or the crankshaft must be replaced.

Crankpin and Bearing Clearance mm(in)

Standard	Limit
0.029 – 0.083 (0.0011 – 0.0033)	0.10 (0.0039)

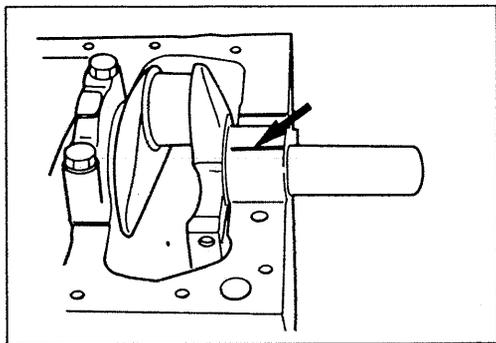

Clearance Measurements (With Plastigage)

Crankshaft Journal and Bearing Clearance



1. Clean the cylinder body, the journal bearing fitting surface, the bearing caps, and the bearings.
2. Install the bearings to the cylinder body.
3. Carefully place the crankshaft on the bearings.
4. Rotate the crankshaft approximately 30° to seat the bearing.
5. Place the Plastigage (arrow) over the crankshaft journal across the full width of the bearing.
6. Install the bearing caps with the bearing.

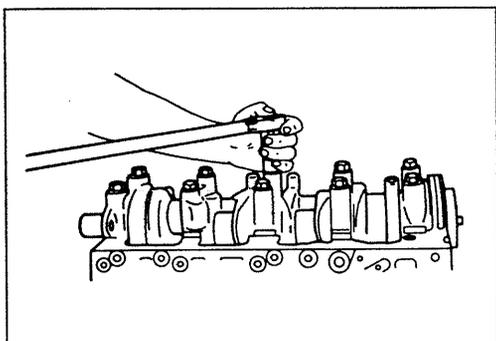

7. Tighten the bearing caps to the specified torque.

Crankshaft Bearing Cap Bolt

Torque kg·m(lb.ft/N·m)

16.0 – 18.0 (116 – 130/157 – 177)

Do not allow the crankshaft to turn during bearing cap installation and tightening.

8. Remove the bearing cap.

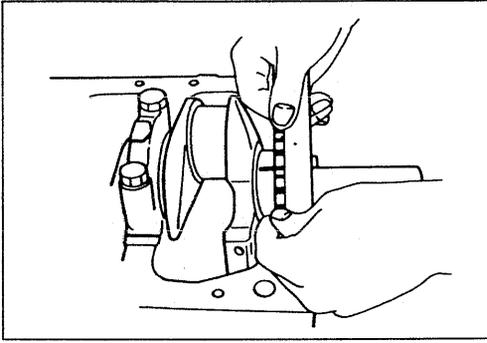

9. Compare the width of the Plastigage attached to either the crankshaft or the bearing against the scale printed on the Plastigage container.

If the measured value exceeds the limit, perform the following additional steps.

- 1) Use a micrometer to measure the crankshaft outside diameter.
- 2) Use an inside dial indicator to measure the bearing inside diameter.

If the crankshaft journal and bearing clearance exceeds the limit, the crankshaft and/or the bearing must be replaced.

Crankshaft Journal and Bearing Clearance		mm(in)
Standard	Limit	
0.031 – 0.063 (0.0012 – 0.0025)	0.11 (0.0043)	

Crankshaft Bearing Selection

When installing new crankshaft bearings or replacing old bearings, select and install bearing part No. 897063-2590 (Identification color: "Black")

Crankpin and Bearing Clearance

1. Clean the crankshaft, the connecting rod, the bearing cap, and the bearings.
2. Install the bearing to the connecting rod and the bearing cap.

Do not allow the crankshaft to move when installing the bearing cap.

3. Prevent the connecting rod from moving.
4. Attach the Plastigage to the crankpin.
Apply engine oil to the Plastigage to keep it from falling.



5. Install the bearing cap and tighten it to the specified torque.

Do not allow the connecting rod to move when installing and tightening the bearing cap.

Connecting Rod Bearing Cap Bolt

Torque kg·m(lb.ft/N·m)

2.8 – 3.2 (20 – 23/727 – 31) → 45° – 60°
--



6. Remove the bearing cap.
7. Compare the width of the Plastigage attached to either the crankshaft or the bearing against the scale printed on the Plastigage container.

If the measured value exceeds the specified limit, perform the following additional steps.



- 1) Use a micrometer to measure the crankpin outside diameter.



- 2) Use an inside dial indicator to measure the bearing inside diameter.

If the crankpin and bearing clearance exceeds the specified limit, the crankshaft and/or the bearing must be replaced.

Crankpin and Bearing Clearance mm(in)

Standard	Limit
0.029 – 0.066 (0.0011 – 0.0026)	0.10 (0.0039)

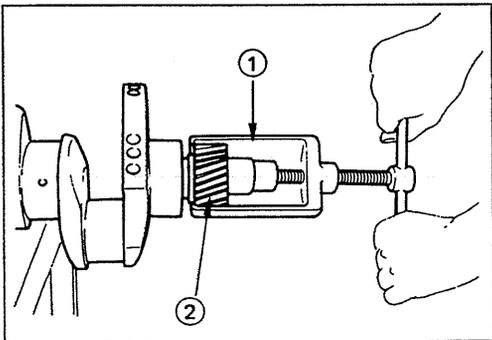

Crankshaft Timing Gear Replacement



Crankshaft Timing Gear Removal

1. Use the crankshaft gear remover ① to remove the crankshaft gear ②.



2. Remove the crankshaft feather key.

Crankshaft Timing Gear Remover: 9-8840-2057-0

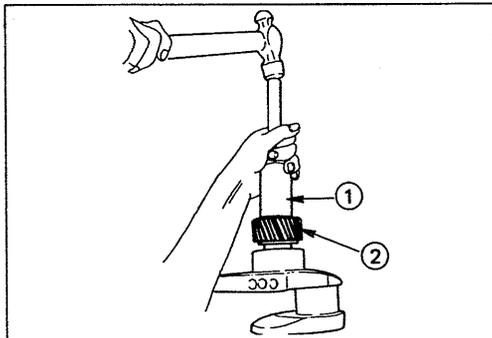

Crankshaft Timing Gear Installation

1. Install the crankshaft gear.
2. Use the crankshaft gear installer ① to install the crankshaft gear ②.



The crankshaft gear timing mark ("X - X") must be facing outward.



Crankshaft Gear Installer: 9-8522-0020-0

CRANKSHAFT PILOT BEARING

Check the crankshaft pilot bearing for excessive wear and damage and replace it if necessary.

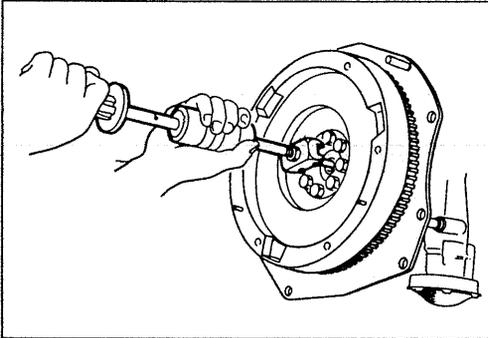

Crankshaft Pilot Bearing Replacement

Crankshaft Pilot Bearing Removal

Use the pilot bearing remover to remove the pilot bearing.



Pilot Bearing Remover: 5-8840-2000-0

Sliding Hammer: 5-8840-0019-0

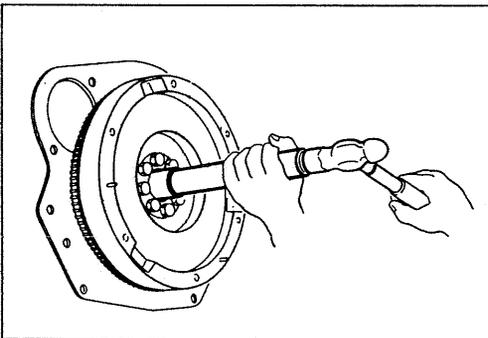

Crankshaft Pilot Bearing Installation

1. Place the crankshaft pilot bearing horizontally across the crankshaft bearing installation hole.
2. Tap around the edges of the crankshaft pilot bearing outer races with a brass hammer to drive the bearing into the crankshaft bearing installation hole.



Pilot Bearing Installer: 5-8522-0024-0

Note:

Strike only the crankshaft pilot bearing outer races with the hammer. Do not strike the bearing inner races. Bearing damage and reduced bearing service life will result.

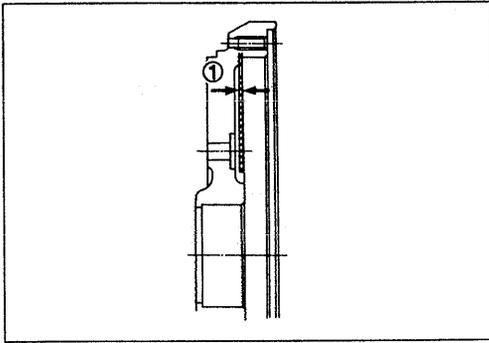

FLYWHEEL AND RING GEAR

Flywheel

1. Inspect the flywheel friction surface for excessive wear and heat cracks.
2. Measure the flywheel friction surface wear amount (depth)

The flywheel friction surface area actually making contact with the clutch driven plate (the shaded area in the illustration) will be smaller than the original machined surface area.

There will be a ridge on the flywheel surface area. Be sure to measure the surface wear in the area inside the ridge.

If the measured value is between the standard and the specified limit, the flywheel may be reground.

If the measured value exceeds the specified limit, the flywheel must be replaced.

Flywheel Friction Surface Depth ①	mm(in)
Limit	
1.0 (0.04) or more	

Note:

Because a ridge is produced at the flywheel friction surface as illustrated, do not measure the friction surface wear amount at the non-ridge area but be sure to measure it at the rear-friction surface which is shown in the illustration by shaded area.

Ring Gear

Inspect the ring gear.

If the ring gear teeth are broken or excessively worn, the ring gear must be replaced.

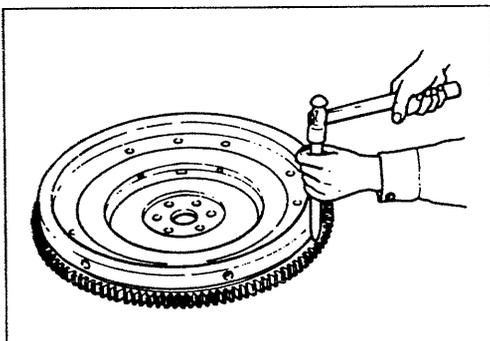

Ring Gear Replacement

Ring Gear Removal

Strike around the edges of the ring gear with a hammer and chisel to remove it.

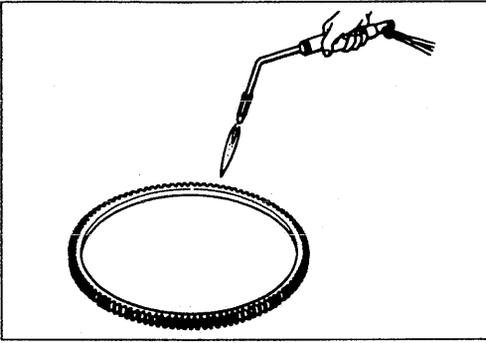

Ring Gear Installation

1. Heat the ring gear evenly with a gas burner to invite thermal expansion.

Do not allow the temperature of the gas burner to exceed 200°C (390°F).

2. Install the ring gear when it is sufficiently heated.

The ring gear must be installed with the chamfer facing the clutch.

Note:

Another method of heating the ring gear to invite thermal expansion is to soak a rag in diesel fuel, wrap the diesel fuel soaked rag around the rim of the ring gear, and then light the rag.

PISTON

Piston Grade Selection and Cylinder Liner Bore Measurement



Refer to the Section "CYLINDER BODY", Item "Cylinder Liner Bore Measurement" for details on piston grade selection and cylinder or liner bore measurement.

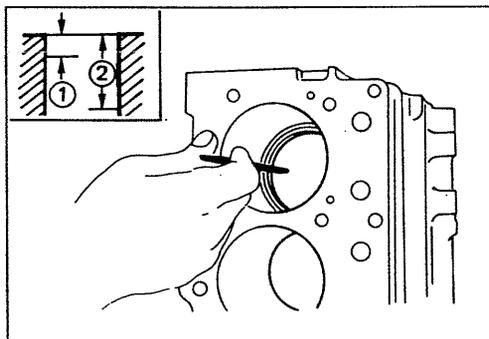
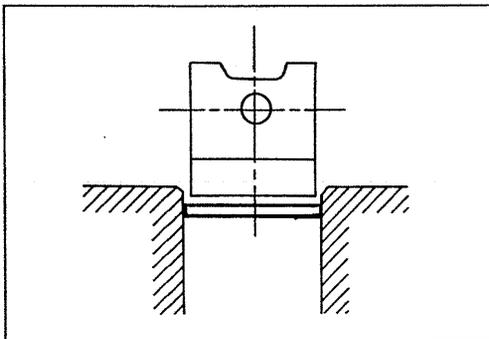

PISTON RING

Piston Ring Gap

1. Insert the piston ring horizontally into the cylinder liner.
2. Use a piston inserted upside down to push the piston ring into the cylinder liner until it reaches either measuring point ① or measuring point ②. Cylinder liner diameter is the smallest at these two points.

Do not allow the piston ring to slant to one side or the other. It must be perfectly horizontal.

3. Use a feeler gauge to measure the piston ring gap.

Measuring Point ① : 10 mm (0.39 in) or
 Measuring Point ② : 120 mm (4.72 in)

If the piston ring gap exceeds the specified limit, the piston ring must be replaced.



Piston Ring Gap

mm(in)

	Standard	Limit
1st Compression Ring	0.2 – 0.35 (0.008 – 0.014)	1.5 (0.059)
2nd Compression Ring	0.37 – 0.52 (0.015 – 0.020)	
Oil Ring	0.2 – 0.4 (0.008 – 0.016)	

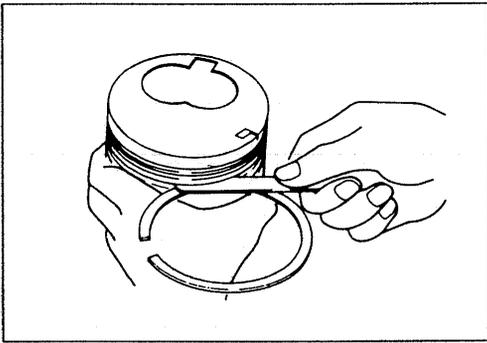

Piston Ring and Piston Ring Groove Clearance



Use a feeler gauge to measure the clearance between the piston ring and the piston ring groove at several points around the piston.

If the clearance between the piston ring and the piston ring groove exceeds the specified limit, the piston ring must be replaced.

Piston Ring and Piston Ring Groove Clearance

mm(in)

	Standard	Limit
1st Compression Ring	0.09 – 0.130 (0.0035 – 0.0051)	0.15 (0.006)
2nd Compression Ring	0.05 – 0.090 (0.002 – 0.0035)	
Oil Ring	0.03 – 0.07 (0.0012 – 0.0028)	



Visually inspect the piston. If a piston ring groove is damaged or distorted, the piston must be replaced.

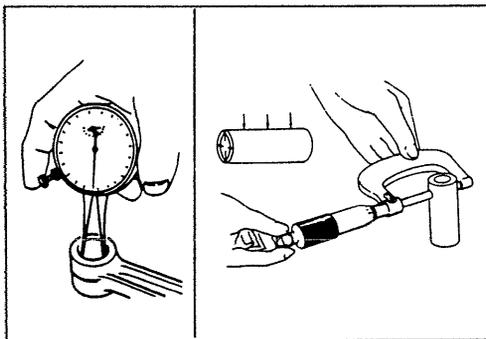
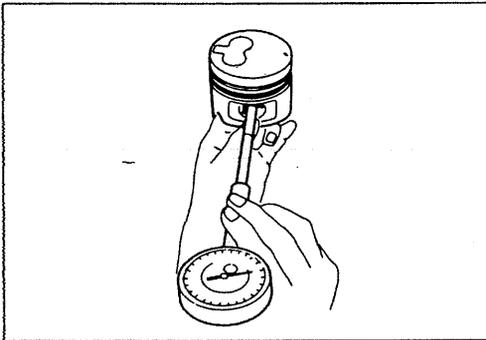
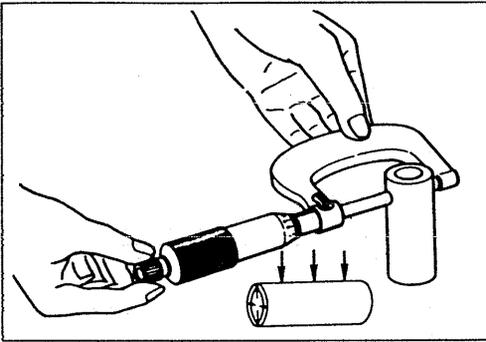

PISTON PIN

Piston Pin Diameter



Use a micrometer to measure the piston pin outside diameter at several points. If the measured value is less than the specified limit, the piston pin must be replaced.

Piston Pin Diameter		mm(in)
Standard	Limit	
33.995 – 34.000 (1.3384 – 1.3386)	33.970 (1.3374)	

Piston Pin and Piston Clearance



Use an inside dial indicator to measure the piston pin hole (in the piston).

Piston Pin Hole		mm(in)
Standard		
34.004 – 34.012 (1.3387 – 1.3391)		

Piston Pin and Piston Pin Hole Clearance

Piston Pin and Piston Pin Hole Clearance		mm(in)
0.004 – 0.015 (0.0002 – 0.0006)		

Piston Pin and Connecting Rod Small End Bushing Clearance



Use a caliper calibrator and a dial indicator to measure the piston pin and connecting rod small end bushing clearance.

If the clearance between the piston pin and the connecting rod small end bushing exceeds the specified limit, replace the piston pin and/or the connecting rod bushing.

Piston Pin and Connecting Rod Small End Bushing Clearance

Piston Pin and Connecting Rod Small End Bushing Clearance		mm(in)
Standard	Limit	
0.008 – 0.019 (0.0003 – 0.0007)	0.05 (0.002)	

Connecting Rod Bushing Replacement

Connecting Rod Bushing Removal



1. Clamp the connecting rod in a vise.
2. Use the connecting rod bushing remover to remove the connecting rod bushing.

Connecting Rod Bushing Replacer

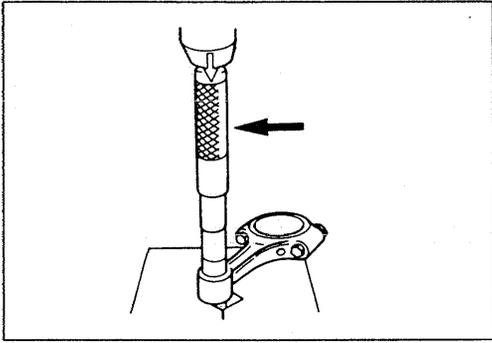

Connecting Rod Bushing Installation

1. Clamp the connecting rod in a vice.
2. Use the connecting rod bushing installer to install the connecting rod bushing.



Connecting Rod Bushing Replacer:

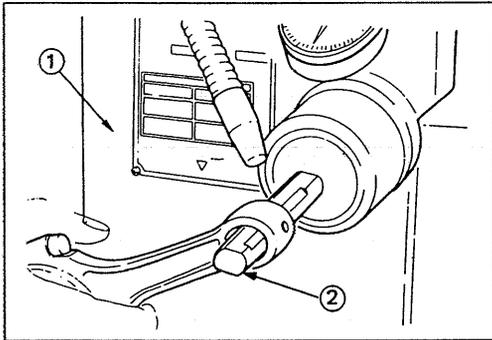

3. Use a piston pin hole grinder ① fitted with a reamer ② to ream the piston pin hole.

Inner Diameter of Small End Bushing mm(in)

Standard
34.008 – 34.015 (1.3389 – 1.3392)

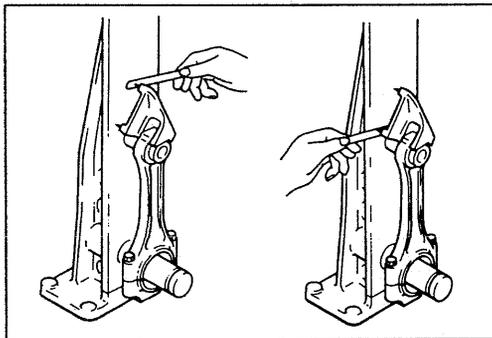

CONNECTING ROD

Connecting Rod Alignment



Use a connecting rod aligner to measure the distortion and the parallelism between the connecting rod big end hole and the connecting rod small end hole.

If either the measured distortion or parallelism exceed the specified limit, the connecting rod must be replaced.

Connecting Rod Alignment

Per Length of 100 mm (3.94 in) mm(in)

	Standard	Limit
Distortion	0.05 or Less (0.0020)	0.20 (0.008)
Parallelism		0.15 (0.006)

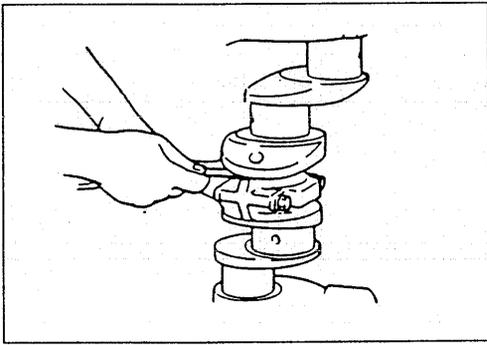

Connecting Rod Side Face Clearance

1. Install the connecting rod to the crankpin.
2. Use a feeler gauge to measure the clearance between the connecting rod big end side face and the crankpin side face.

If the measured value exceeds the specified limit, the connecting rod must be replaced.

Connecting Rod and Crankpin Side Face Clearance

		mm(in)
Standard		Limit
0.175 – 0.290 (0.0069 – 0.0114)		0.35 (0.014)

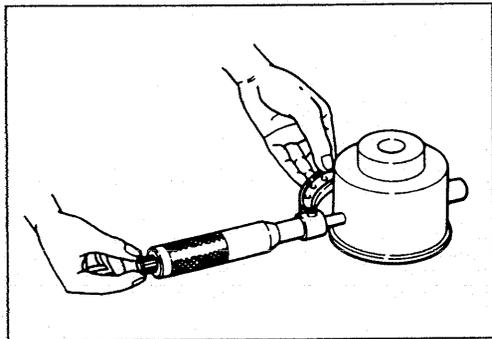

IDLER GEAR SHAFT AND IDLER GEAR

Idler Gear Shaft Outside Diameter

Use a micrometer to measure the idler gear shaft outside diameter.

If the measured value is less than the specified limit, the idler gear must be replaced.

Idler Gear Shaft Outside Diameter

		mm(in)
Standard		Limit
44.945 – 44.975 (1.769 – 1.771)		44.90 (1.767)

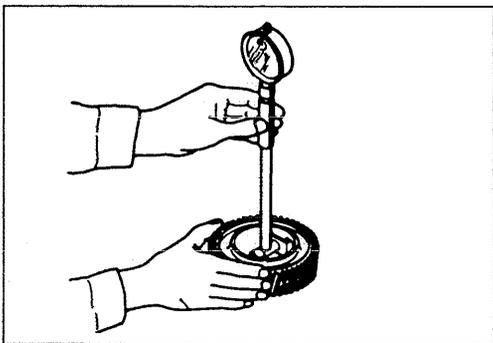

Idler Gear "A" Inside Diameter



1. Use an inside dial indicator to measure the idler gear

Idler Gear Inside Diameter mm(in)

Standard	Limit
45.0 – 45.03 (1.7717 – 1.7718)	45.10 (1.7756)

If the clearance between the idler gear shaft outside diameter and the idler gear inside diameter exceeds the limit, the idler gear must be replaced.

Idler Gear Shaft and Idler Gear

Clearance mm(in)

Standard	Limit
0.025 – 0.085 (0.0010 – 0.0033)	0.2 (0.008)

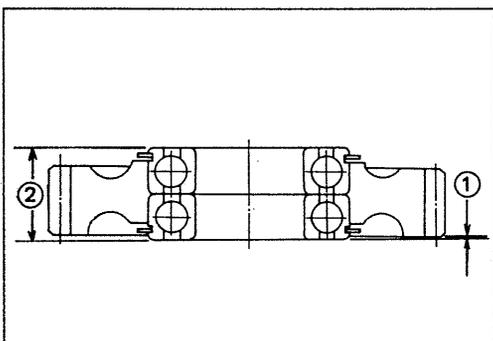

Idler Gear "B"



Bearing replacement

Use a suitable bar and a bench press or hammer.

Bearing projection amount should be within the specified height.

mm(in)

Projection	①	0.4 – 0.6 (0.016 – 0.024)
Height	②	23.7 – 24.0 (0.933 – 0.945)

TIMING GEAR CASE COVER

Replace the crankshaft front oil seal if it is excessively worn or damaged.

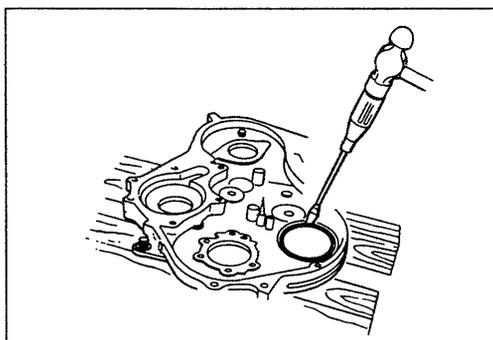

Crankshaft Front Oil Seal Replacement



Oil Seal Removal

Use a plastic hammer and a screwdriver to tap around the oil seal to free it from the gear case.

Take care not to damage the oil seal fitting surfaces.

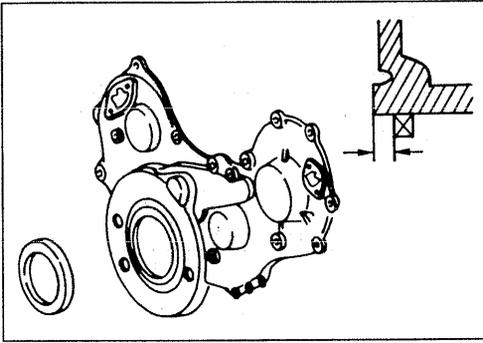

Oil Seal Installation

1. Apply a coat of engine oil to the oil seal lip circumference.
2. Use the oil seal installer and the installer grip to insert the oil seal 1 mm (0.039 in) into the front portion of the timing gear case.

Oil Seal Installer: 5-8840-2061-0

SECTION 5

ENGINE ASSEMBLY (3)

TABLE OF CONTENTS

ITEM	PAGE
Reassembly.....	86

 REASSEMBLY

SINGLE UNIT

ROCKER ARM SHAFT AND ROCKER ARM

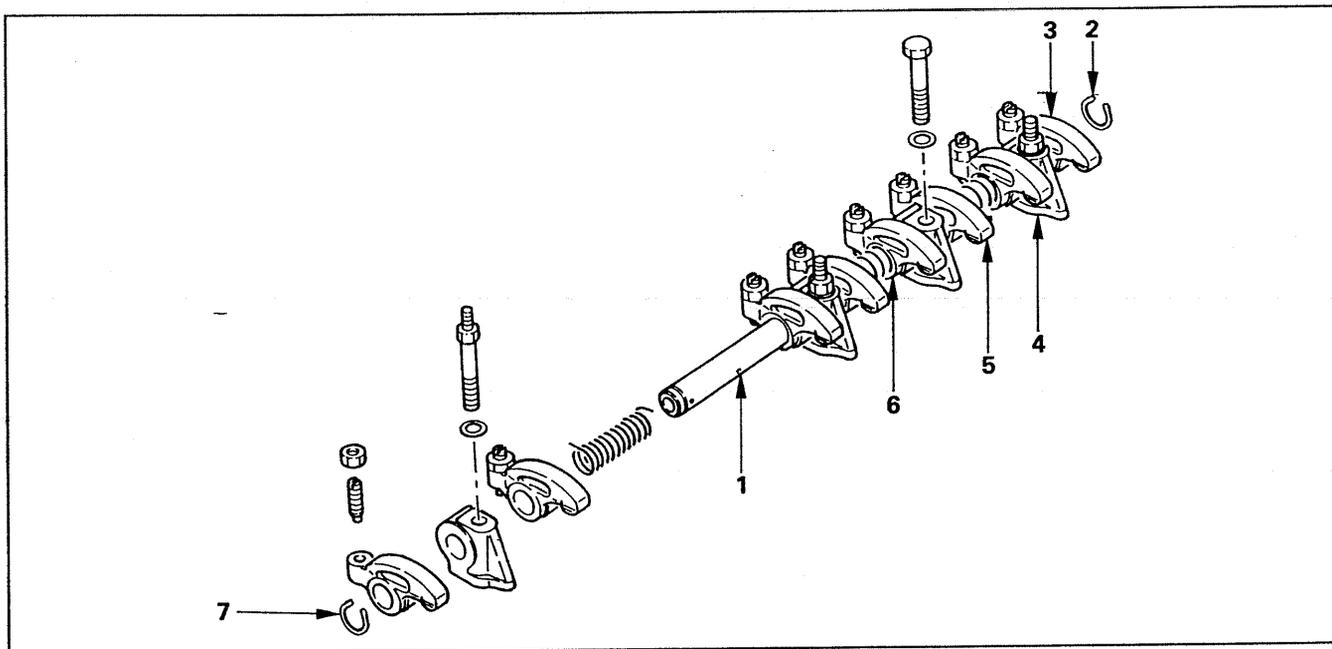

Reassembly Steps

- ▲ 1. Rocker arm shaft
- 2. Rocker arm shaft snap ring
- 3. Rocker arm
- 4. Rocker arm shaft bracket
- 5. Rocker arm
- 6. Rocker arm shaft spring
- 7. Rocker arm shaft snap ring



Important Operations

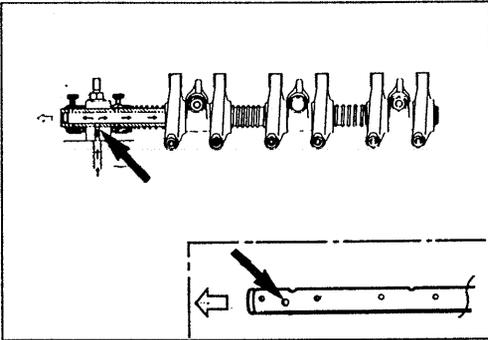

1. Rocker Arm Shaft

- 1) Position the rocker arm shaft with the large oil hole (4 ϕ) facing the front of the engine.
- 2) Install the rocker arm shaft together with the rocker arm, the rocker arm shaft bracket, and the spring.

CYLINDER HEAD

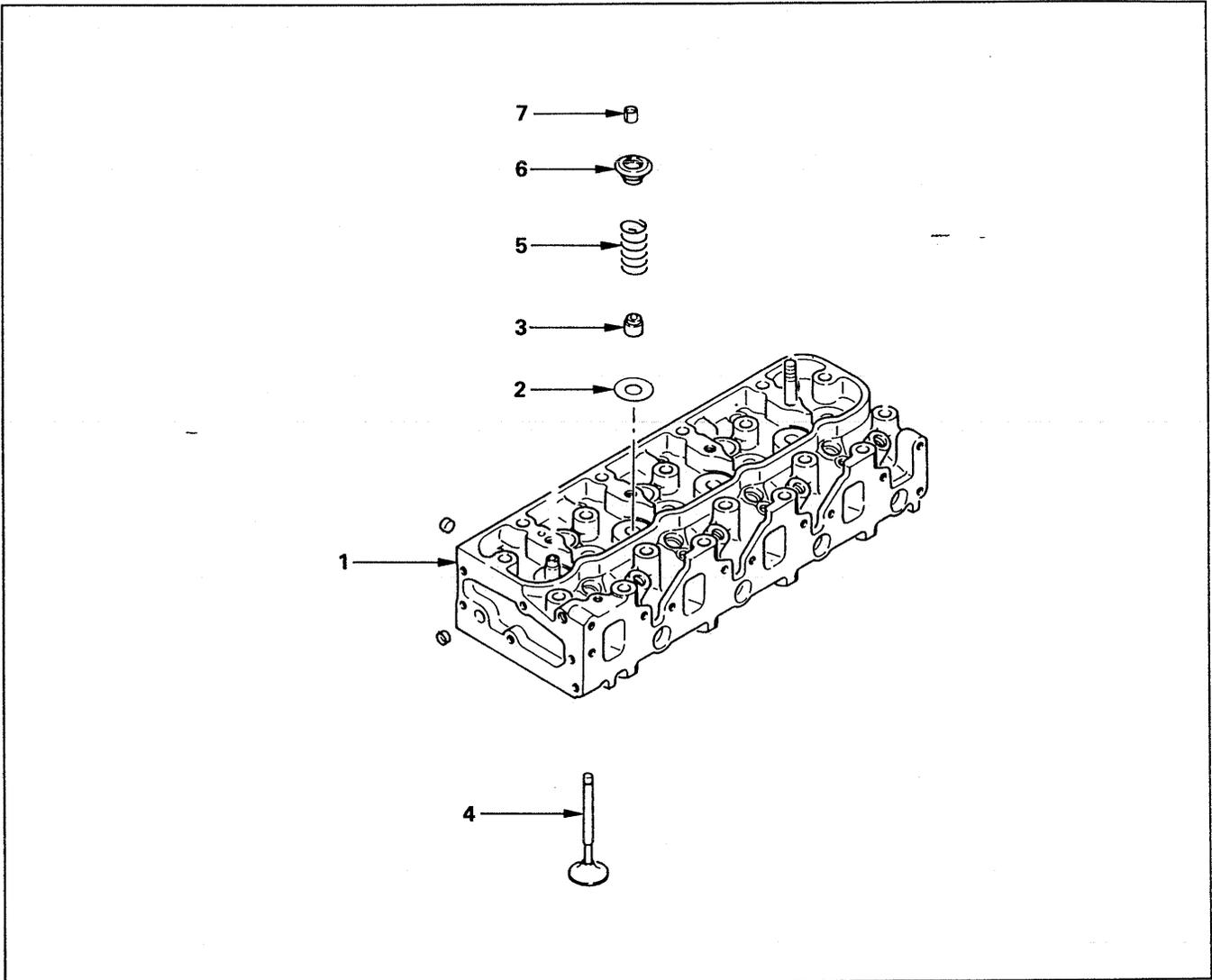

Reassembly Steps

- 1. Cylinder head
- 2. Valve spring lower seat
- ▲ 3. Valve stem oil seal
- ▲ 4. Intake and exhaust valve
- ▲ 5. Valve spring
- 6. Valve spring upper seat
- ▲ 7. Split collar



Important Operations

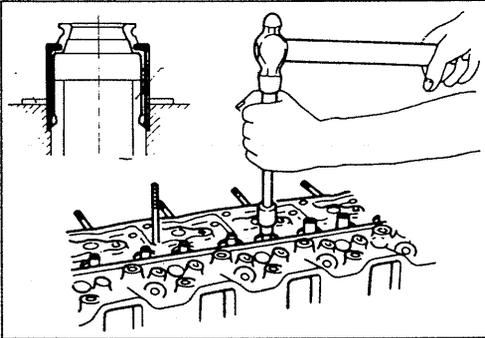

3. Valve Stem Oil Seal

- 1) Apply a coat engine oil to the oil seal inner face.
- 2) Use an oil seal installer to install the oil seal to the valve guide.

Oil Seal Installer: 5-8840-2033-0

4. Intake and Exhaust Valve



- 1) Apply a coat of engine oil to valve stem.
- 2) Install the intake and exhaust valves.
- 3) Turn the cylinder head up to install the valve springs.

Take care not to allow the installed valves to fall free.

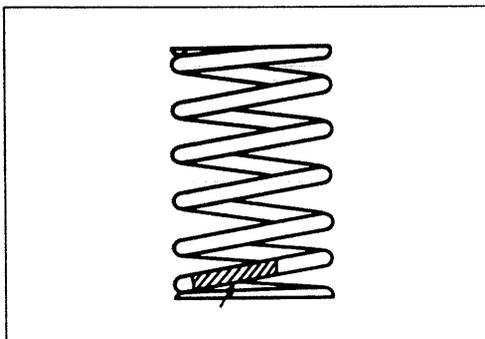

5. Valve Spring

- 1) Turn the cylinder head up to install the valve springs.
- 2) Install the valve springs with the fine pitched end (painted pink) facing down.

Take care not to allow the installed valves to fall free.

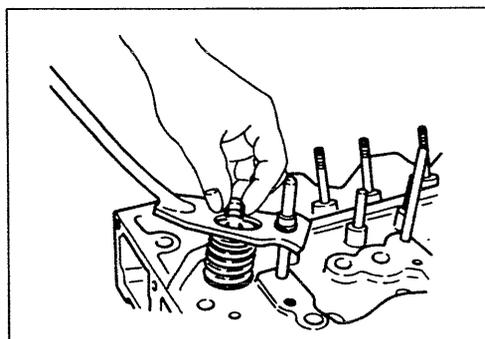

7. Split Collar

- 1) Use the spring compressor to push the valve spring into position.

Spring Compressor: 9-8523-1423-0

- 2) Install the split collar to the valve stem.
- 3) Set the split collar by tapping around the bead of the collar with a rubber hammer.

PISTON AND CONNECTING ROD

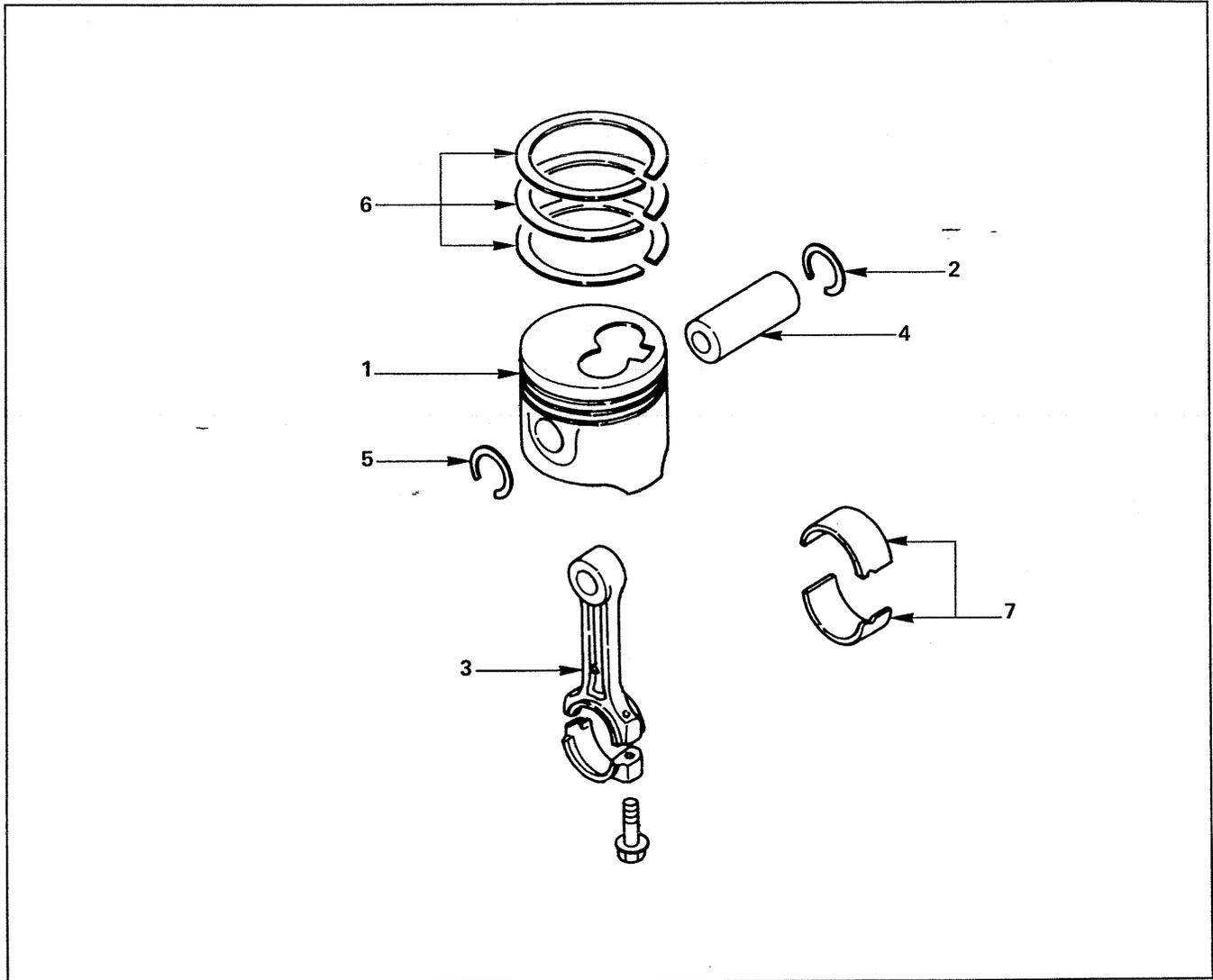

Reassembly Steps

- ▲ 1. Piston
- ▲ 2. Piston pin snap ring
- ▲ 3. Connecting rod
- ▲ 4. Piston pin
- ▲ 5. Piston pin snap ring
- ▲ 6. Piston ring
- ▲ 7. Connecting rod bearing



Important Operations

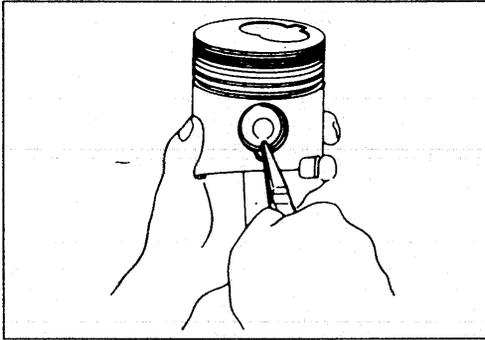

1. Piston
2. Piston pin snap ring
3. Connecting rod

- 1) Clamp the connecting rod in a vise.
Take care not to damage the connecting rod.
- 2) Use a pair of snap ring pliers to install the piston pin snap ring to the piston.

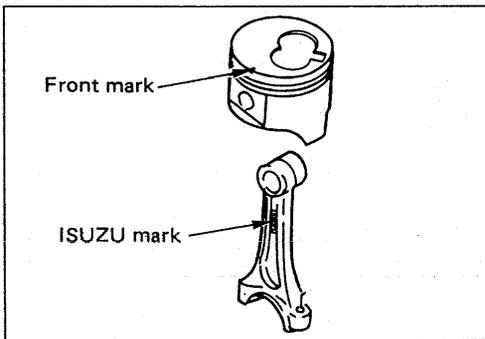

- 3) Install the piston to the connecting rod.
The piston head front mark and the connecting rod "ISUZU" casting mark must be facing the same direction.

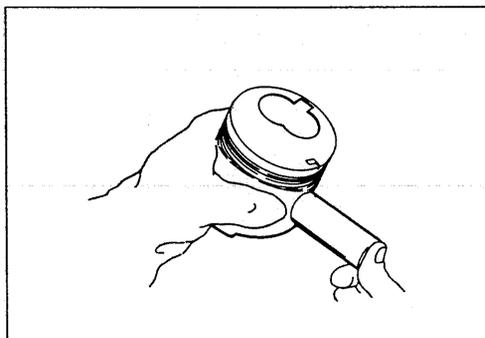

4. Piston pin

- 1) Apply a coat of engine oil to the piston pin and the piston pin hole.
- 2) Use your fingers to force the piston pin into the piston until it makes contact with the snap ring.

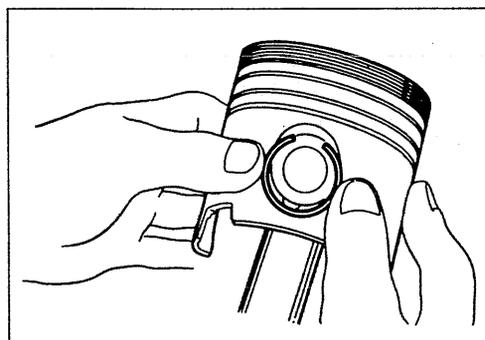

- 3) Use your fingers to force the piston pin snap ring into the piston snap ring groove.
- 4) Check that the connecting rod moves smoothly on the piston pin.

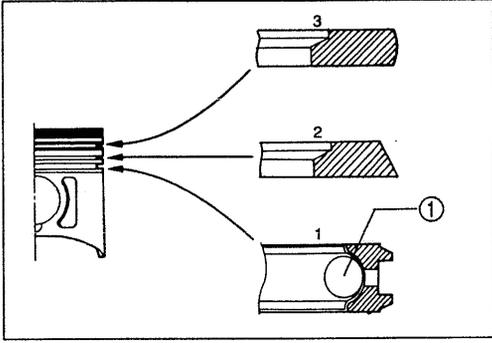

6. Piston Ring



- 1) Use a piston ring replacer to install the three piston rings.

Piston Ring Replacer:

Install the piston rings in the order shown in the illustration.

- ① Oil ring (Coil expander type)
- ② 2nd compression ring (Taper type)
- ③ 1st compression ring (Barrel face type)

Note:



Install the compression rings with the stamped side facing up.

Insert the expander coil into the oil ring groove so that there is no gap on either side of the expander coil before installing the oil ring.



- 2) Apply engine oil to the piston ring surfaces.
- 3) Check that the piston rings rotate smoothly in the piston ring grooves.

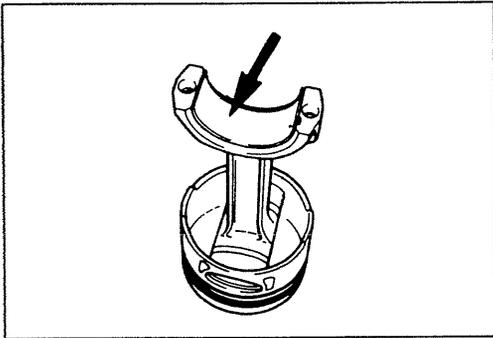

7. Connecting Rod Bearing

Carefully wipe any oil or other foreign material from the connecting rod bearing back face and the connecting rod bearing fitting surface.

CAMSHAFT, CAMSHAFT TIMING GEAR, AND THRUST PLATE

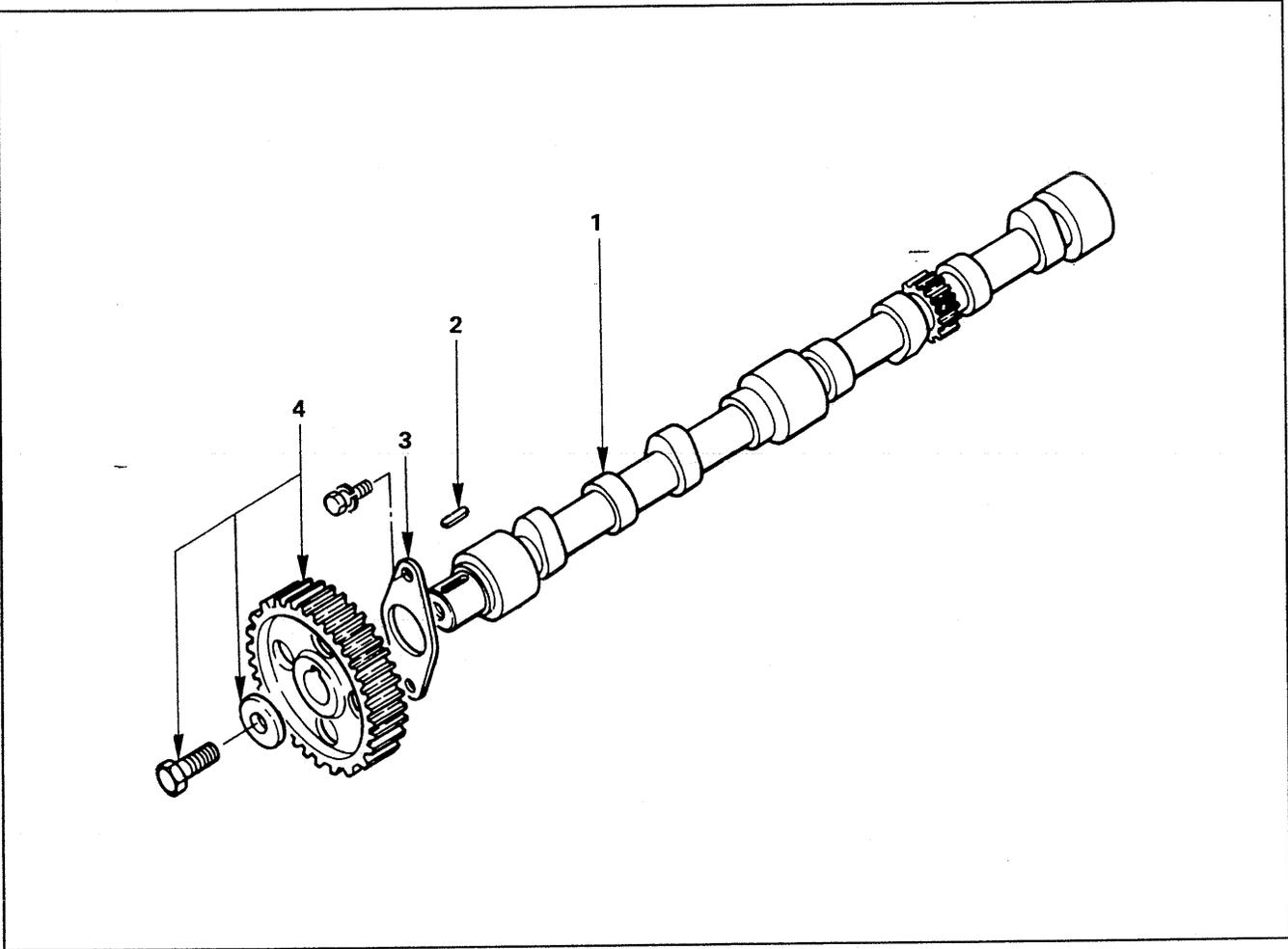

Reassembly Steps

- 1. Camshaft
- 2. Feather key
- 3. Thrust plate
- ▲ 4. Camshaft timing gear



Important Operations

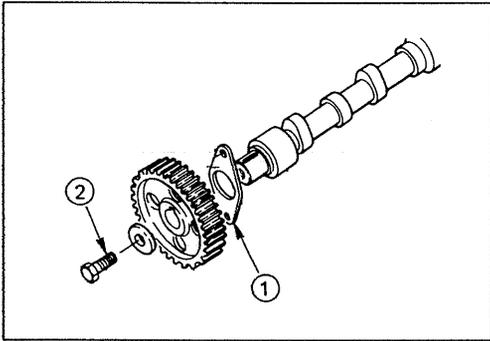

4. Camshaft Timing Gear

- 1) Install the thrust plate ① .
- 2) Apply engine oil to the bolt threads ② .
- 3) Install the camshaft timing gear with the timing mark stamped side facing out.



Camshaft Timing Gear Bolt Torque kg·m(lb.ft/N·m)

10.0 – 12.0 (72 – 87/98 – 118)

MEMO

A series of horizontal dotted lines for writing a memo.



REASSEMBLY

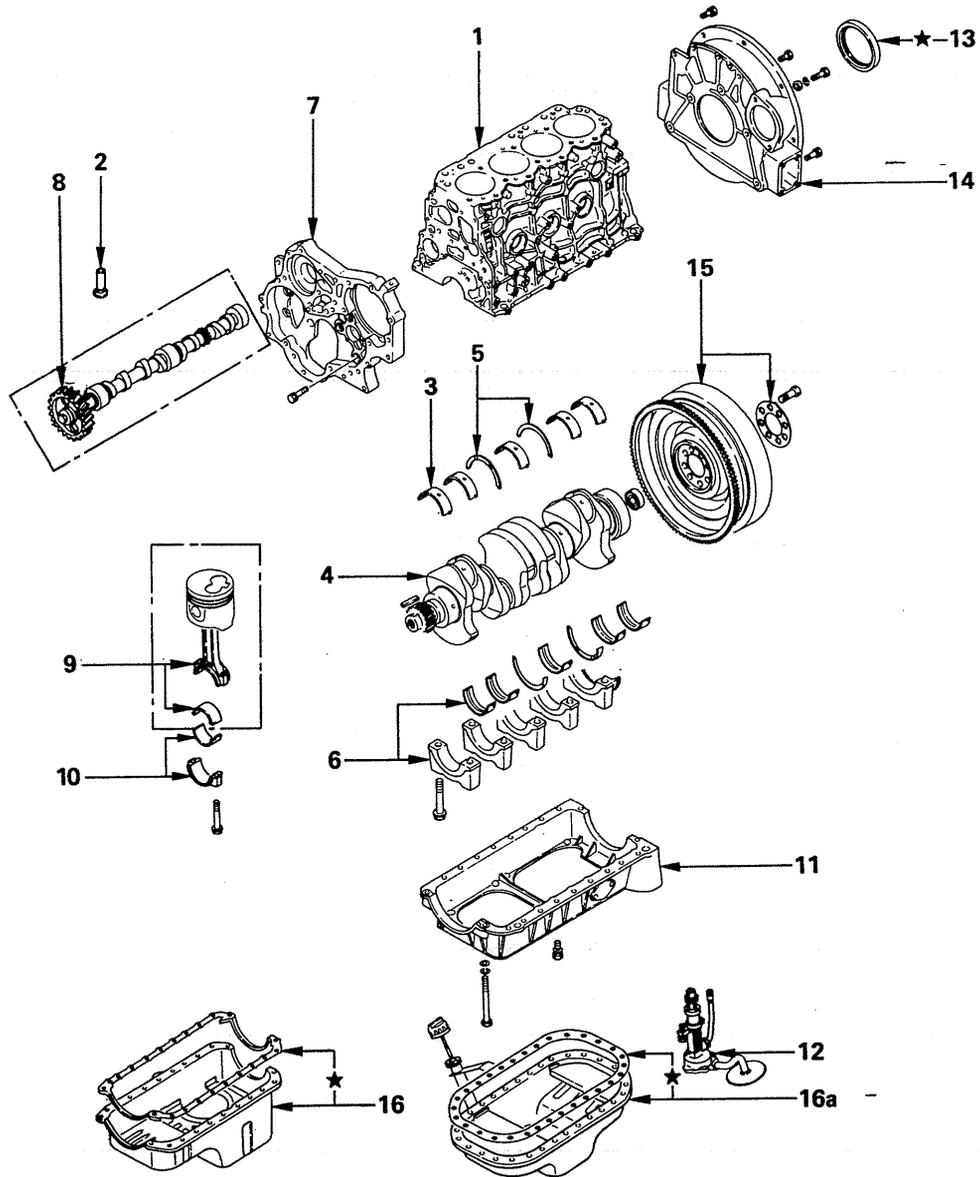

★ Repair kit

Reassembly Steps - 1

- ▲ 1. Cylinder body
- ▲ 2. Tappet
- ▲ 3. Crankshaft upper bearing
- ▲ 4. Crankshaft with crankshaft timing gear
- ▲ 5. Crankshaft thrust bearing
- ▲ 6. Crankshaft bearing cap with lower bearing
- ▲ 7. Timing gear case
- ▲ 8. Camshaft with camshaft timing gear and thrust plate
- ▲ 9. Piston and connecting rod with upper bearing
- ▲ 10. Connecting rod cap with lower bearing
- ▲ 11. Crankcase (If so equipped)
- ▲ 12. Oil pump with oil pipe
- ▲ 13. Crankshaft rear oil seal
- ▲ 14. Flywheel housing
- ▲ 15. Flywheel
- ▲ 16. Oil pan
- ▲ 16a Oil pan (If so crankcase equipped)

Inverted Engine

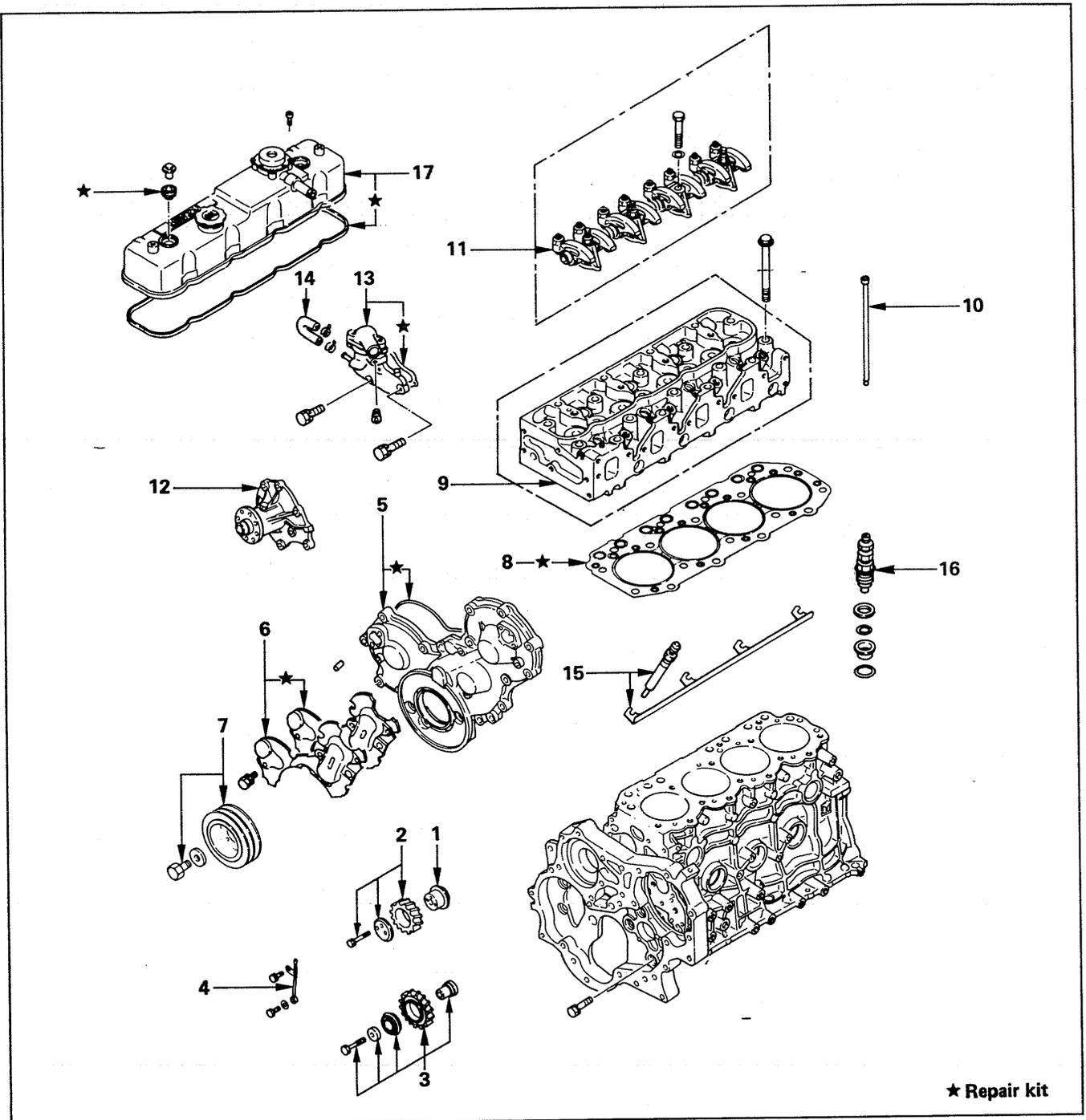

★ Repair kit

Reassembly Steps - 2

- ▲ 1. Idler gear shaft
- ▲ 2. Idler gear "A"
- ▲ 3. Idler gear "B"
- ▲ 4. Timing gear oil pipe
- ▲ 5. Timing case cover
- ▲ 6. Timing gear case cover
- ▲ 7. Crankshaft damper pulley
- ▲ 8. Cylinder head gasket
- ▲ 9. Cylinder head
- ▲ 10. Push rod
- ▲ 11. Rocker arm shaft and rocker arm
- ▲ 12. Water pump
- ▲ 13. Thermostat housing
- ▲ 14. Water by-pass hose
- ▲ 15. Glow plug and glow plug connector seal
- ▲ 16. Injection nozzle holder
- ▲ 17. Cylinder head cover

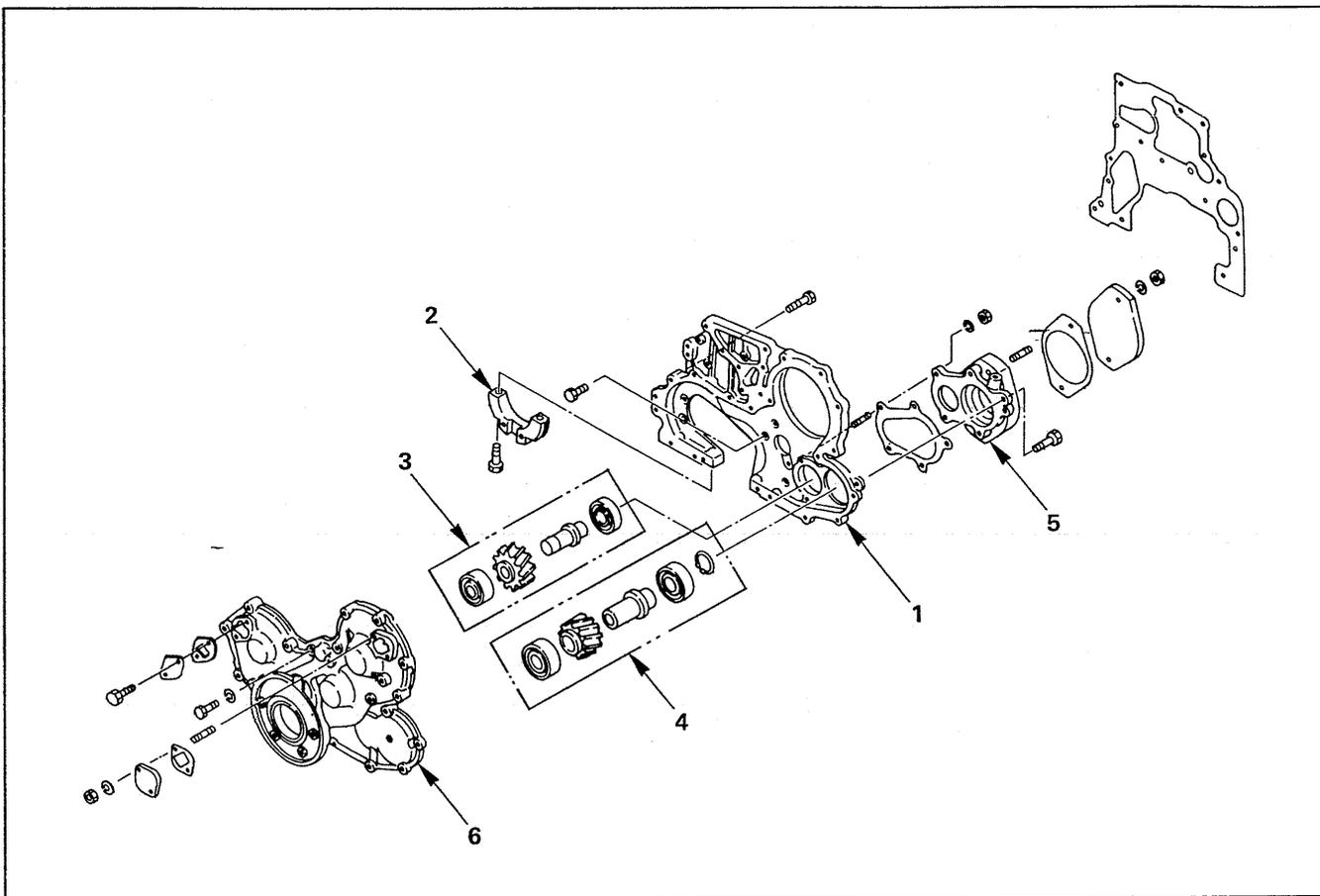

Reassembly Steps – 2a: Timing Gear Case PTO

- | | |
|---------------------|----------------------|
| 1. Timing gear case | 4. PTO Gear |
| 2. Under plate | 5. Adapter : PTO |
| 3. PTO Idle gear | 6. Timing case cover |



Important Operations (Reassembly Steps-1)

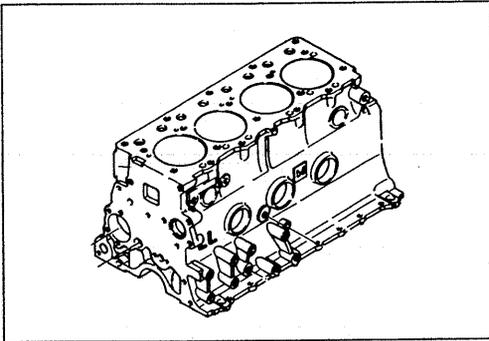

1. Cylinder Body



Use compressed air to thoroughly clean the inside and outside surfaces of the cylinder body, the oil holes, and the water jackets.

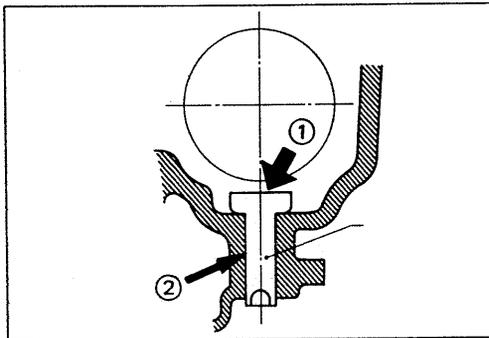

2. Tappet



- 1) Apply a coat of engine oil to the tappet ① and the cylinder body tappet insert holes ②.
- 2) Locate the position mark applied at disassembly (if the tappet is to be reused).

Note:

The tappet must be installed before installing the camshaft.

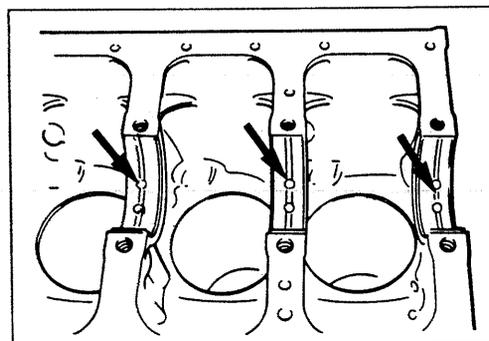

3. Crankshaft Upper Bearing

The crankshaft upper bearings have an oil hole and an oil groove. The lower bearings do not.



- 1) Carefully wipe any foreign material from the crankshaft upper bearing and the crankshaft upper bearing fitting surfaces.
- 2) Locate the position mark applied at disassembly if the removed crankshaft upper bearings are to be reused.

4. Crankshaft with Crankshaft Timing Gear



Apply an ample coat of engine oil to the crankshaft journals and the crankshaft bearing surfaces before installing the crankshaft.

Note:

Do not apply engine oil to the bearing back faces and the cylinder body bearing fitting surfaces.

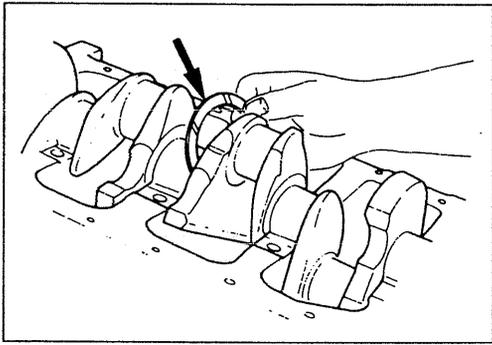

5. Crankshaft Thrust Bearing

- 1) Apply an ample coat of engine oil to the crankshaft thrust bearings.
- 2) Install the crankshaft thrust bearings to the crankshaft center journal.

The crankshaft thrust bearing oil groove must be facing the sliding face.

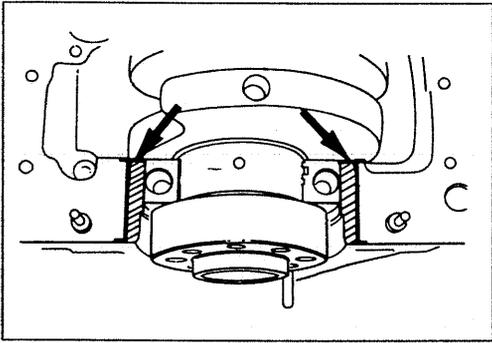

6. Crankshaft Bearing Cap with Lower Bearing

- 1) Apply silicon adhesive to the cylinder body No. 5 bearing cap fitting surface at the points shown in the illustration.

Note:

Be sure that the bearing cap fitting surface is completely free of oil before applying the silicon adhesive.

Do not allow the silicon adhesive to obstruct the cylinder thread holes and bearings.

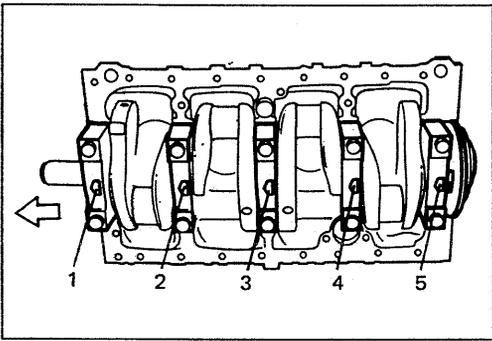

- 2) Install the bearing caps.

The bearing cap arrow marks must be facing the front of the engine.

The arrow mark journal number must correspond to the journal to which the bearing cap is installed.

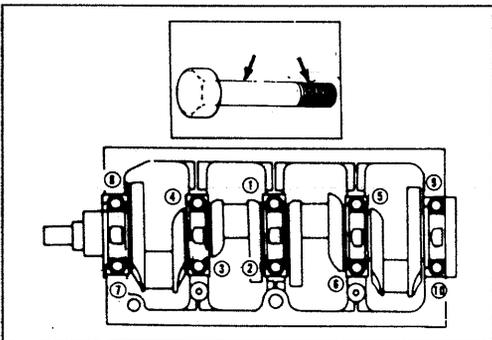

- 3) Apply a coat of engine oil to the bearing cap bolts.

- 4) Tighten the crankshaft bearing cap bolts to the specified torque a little at a time in the sequence shown in the illustration.

Crankshaft Bearing Cap Torque kg·m(lb.ft/N·m)

16.0 – 18.0 (116 – 130/157 – 177)

- 5) Check to see that the crankshaft turns smoothly by rotating it manually.

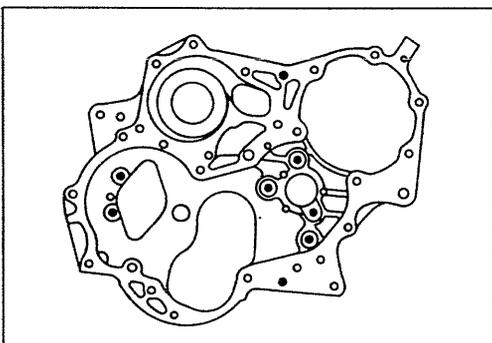

7. Timing Gear Case

- 1) Tighten the timing gear case with timing gear case gasket to the specified torque.

Timing Gear Case Bolt Torque kg·m(lb.ft/N·m)

1.4 – 2.4 (10 – 17/14 – 24)

- 2) Cut away any excessive flash from the timing gear gasket.

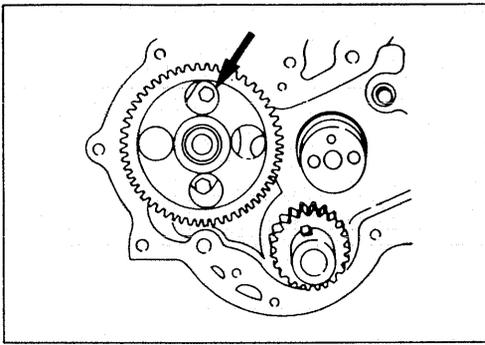

8. Camshaft with Camshaft Timing Gear and Thrust Plate

- 1) Apply a coat of engine oil to the camshaft and the camshaft bearings.
- 2) Install the camshaft to the cylinder body.
Take care not to damage the camshaft bearings.
- 3) Tighten the thrust plate to the specified torque.



Thrust Plate Bolt Torque kg·m(lb.ft/N·m)

1.4 – 2.4 (10 = 17/14 – 24)

- 4) Check to see that the camshaft turns smoothly by rotating it manually.

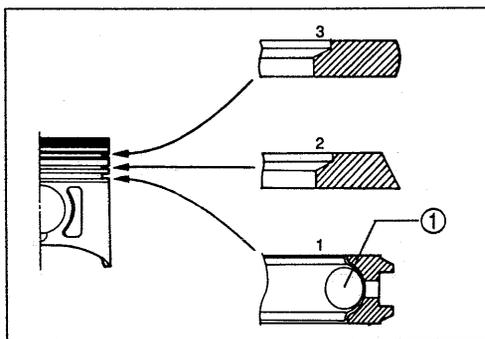

9. Piston and Connecting Rod with Upper Bearing

10. Connecting Rod Bearing Cap with Lower Bearing

- 1) Apply a coat of engine oil to the circumference of each piston ring and piston.

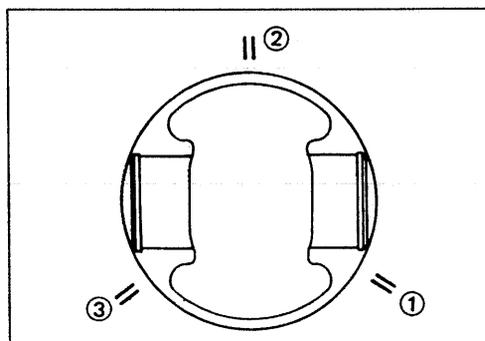

- 2) Position the piston ring gaps as shown in the illustration.

- ① 1st compression ring
- ② 2nd compression ring
- ③ Oil ring

- 3) Apply a coat of molybdenum disulfide grease to the two piston skirts.

This will facilitate smooth break-in when the engine is first started after reassembly.

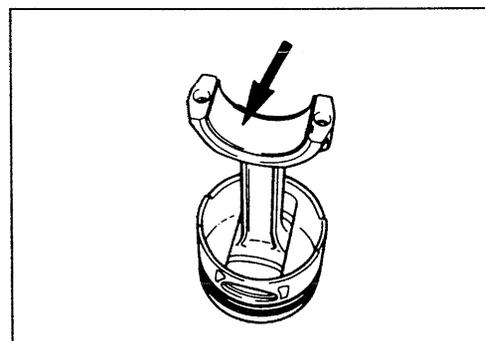

- 4) Apply a coat of engine oil to the upper bearing surfaces.

Note:



Do not apply engine oil to the bearing back faces and the connecting rod bearing fitting surfaces.

- 5) Apply a coat of engine oil to the cylinder wall.

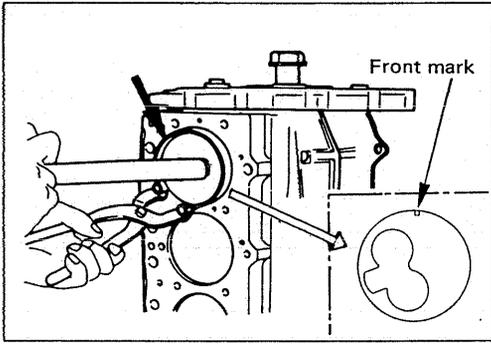

- 6) Position the piston head front mark so that it is facing the front of the cylinder body.
- 7) Use a piston ring compressor to compress the piston rings.

Piston Ring Compressor

- 8) Use a hammer grip to push the piston in until the connecting rod makes contact with the crankpin.

At the same time, rotate the crankshaft until the crankpin is at BDC.

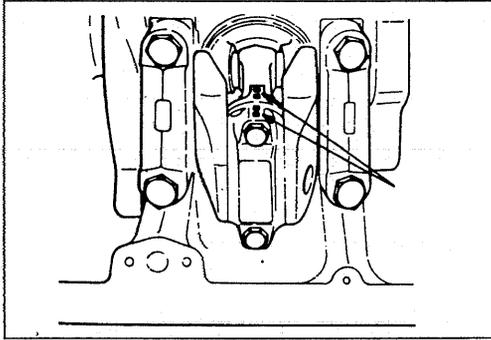

- 9) Install the connecting rod bearing caps. The bearing cap front marks must be facing the front of the engine.

The bearing cap number (at the side of the bearing cap) and the connecting rod number must be the same.

Note:

It is absolutely essential that the bearing caps be installed in the correct direction. Reversing the bearing cap direction will result in serious engine damage.

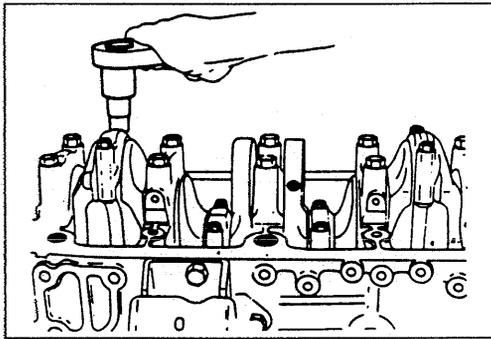

- 10) Apply a coat of engine oil to the threads and setting faces of each connecting rod cap bolt.
- 11) Tighten the connecting rod caps to the specified torque.

Connecting Rod Cap Bolt Torque	kg·m(lb.ft/N·m)
	2.8 – 3.2 → 45° – 60° (20 – 23/27 – 31)

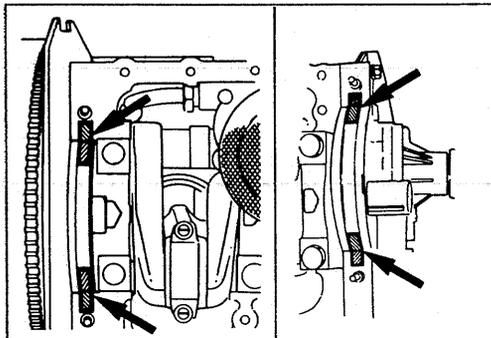

11. Crankcase (if so equipped)

- 1) Apply sealant to the No. 5 bearing cap arches, the bearing grooves, and the timing gear case arches at the positions shown in the illustration.

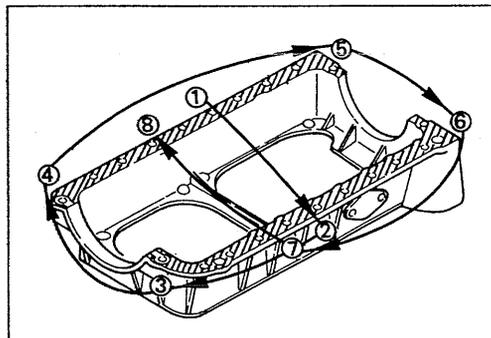

- 2) Apply sealant to the crankcase cylinder body fitting area.
- 3) Tighten the crankcase bolts to the specified torque a little at a time in the sequence shown in the illustration.

Crankcase Bolt Torque	kg·m(lb.ft/N·m)
	1.4 – 2.4 (10.1 – 17.3/13.7 – 23.5)

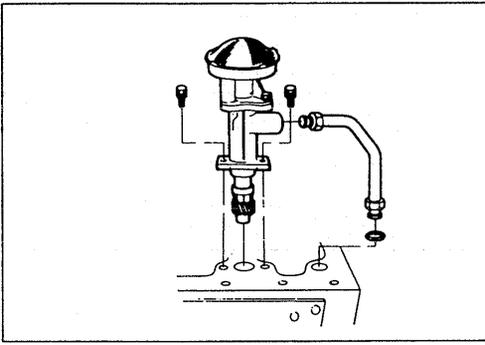

12. Oil Pump with Oil Pipe

Install the oil pump with the oil pipe and tighten the bolts to the specified torque.

Oil Pump Bolt Torque	kg·m(lb.ft/N·m)
	1.4 – 2.4 (10 – 17/14 – 24)

Note:

Take care not to damage the O-rings when tightening the oil pipe bolts.

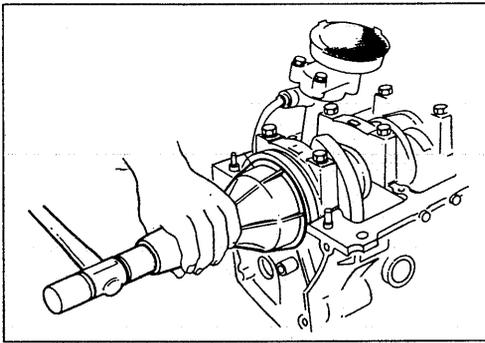

13. Crankshaft Rear Oil Seal (TYPE I)

- 1) Apply engine oil to the oil seal lip circumference and the oil seal outer circumference.
- 2) Use the oil seal installer to install the oil seal to the cylinder body.

Oil Seal Installer: 5-8840-0141-0

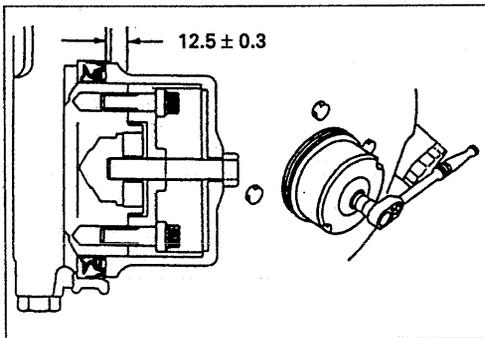

13. Crankshaft Rear Oil Seal (TYPE II)

- 1) Tighten the adapter to the crankshaft rear and section with 2 bolts.
- 2) Insert the oil seal into the peripheral section of adapter.
- 3) Insert the sleeve into the adapter section, and 1) tighten it with a bolt (M12 x 1.75L = 70) until the adapter section hits the sleeve.
- 4) Remove the adapter and the sleeve.
- 5) With the seal pressed in, check the dimension of the oil seal section.

Standard Dimension = 12.5 ± 0.3 mm

Oil Seal Installer: 5-8840-2359-0

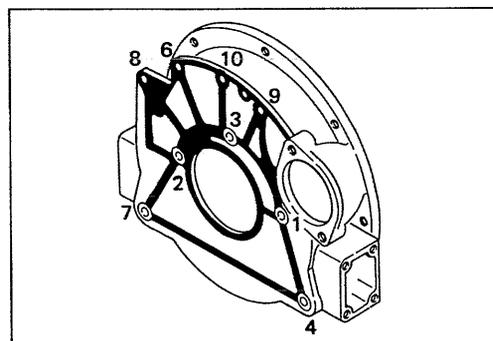

14. Flywheel Housing

- 1) Apply sealant to the shaded area shown in the illustration.
- 2) Tighten the flywheel housing bolts to the specified torque a little at a time in the sequence shown in the illustration.

Flywheel Housing Bolt Torque	kg·m(lb.ft/N·m)
M10x1.25	3.6 – 4.6 (26 – 33/35 – 45)
M12x1.5	7.5 – 9.3 (54 – 67/74 – 91)

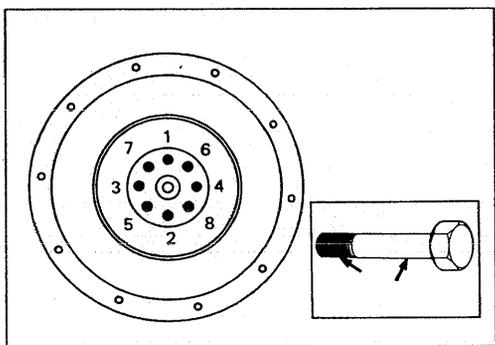

15. Flywheel

- 1) Block the flywheel with a piece of wood to prevent it from turning.
- 2) Apply a coat of engine oil to the threads of the flywheel bolts.
- 3) Tighten the flywheel bolts in the numerical order shown in the illustration.



Flywheel Bolt Torque	kg-m(lb.ft/N-m)
11.5 – 12.5 (83 – 90/113 – 123)	

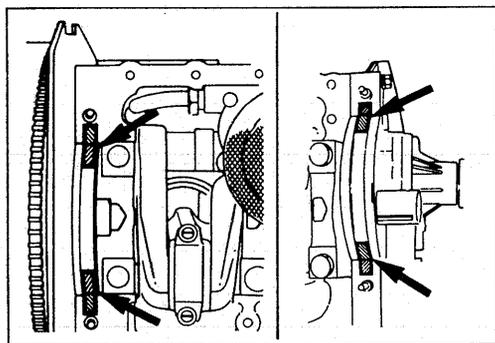

16. Oil Pan



- 1) Apply sealant to the No. 5 bearing cap arches, the bearing grooves, and the timing gear case arches at the positions shown in the illustration.

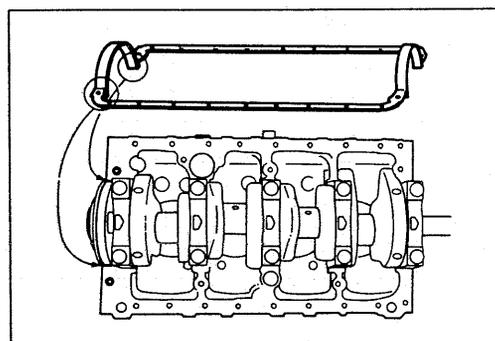

- 2) Fit the gasket rear lipped portion into the No. 5 bearing cap groove.

Be absolutely sure that the lipped portion is fitted snugly in the groove.

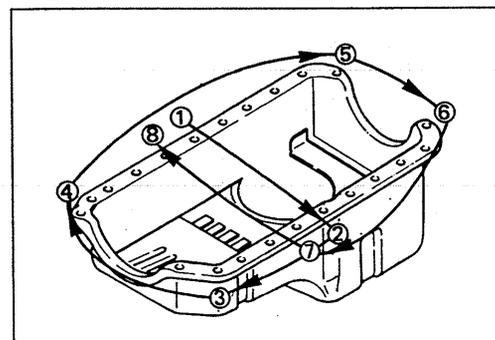

- 3) Tighten the oil pan bolts to the specified torque a little at a time in the sequence shown in the illustration.

Oil Pan Bolt Torque	kg-m(lb.ft/N-m)
0.6 – 1.0 (4.3 – 7.2/6 – 10)	



Important Operations (Reassembly Steps-2)

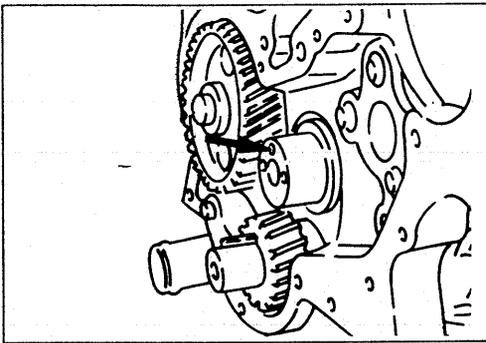

1. Idler Gear Shaft

The idler gear shaft oil hole must be facing up.

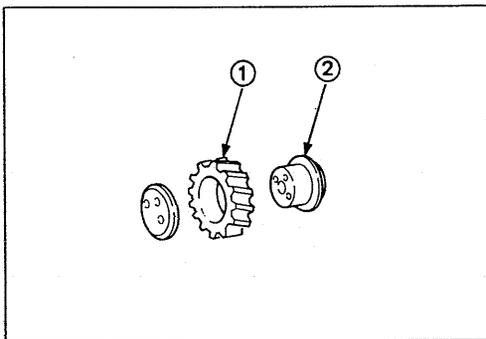

2. Idler Gear "A"

1) Apply engine oil to the idler gear ① and the idler gear shaft ② .



2) Position the idler gear setting marks "X" and "Y" so that they are facing the front of the engine.

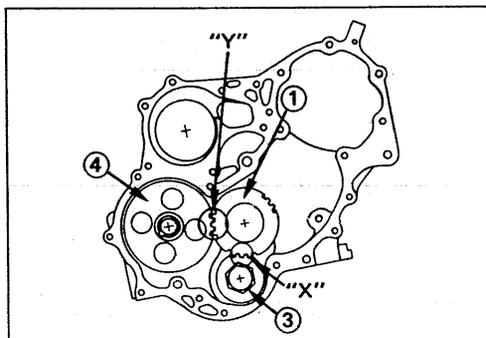

3) Align the idler gear "X - X" setting mark with the crankshaft timing gear ③ "X" setting mark.



4) Align the idler gear "Y - Y" setting mark with the camshaft timing gear ④ "Y" setting mark.

5) Tighten the idler gear bolt to the specified torque.

Idler Gear "A" Bolt Torque kg·m(lb.ft/N·m)

2.1 – 3.1 (15 – 22/21 – 30)

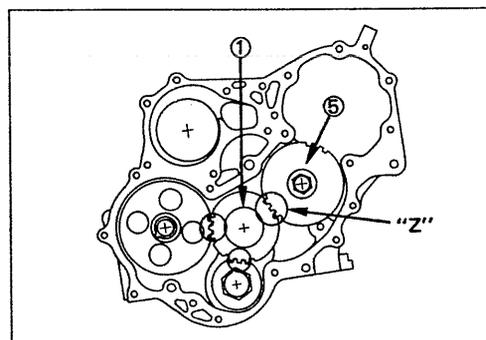

3. Idler Gear "B"

1) Apply engine oil to the idler gear and the idler gear shaft.

2) Align the idler gear ⑤ "Z" setting mark with the idler gear ① "Z - Z" setting mark.



Idler Gear "B" Bolt Torque kg·m(lb.ft/N·m)

9.5 – 11.5 (69 – 83/93 – 113)

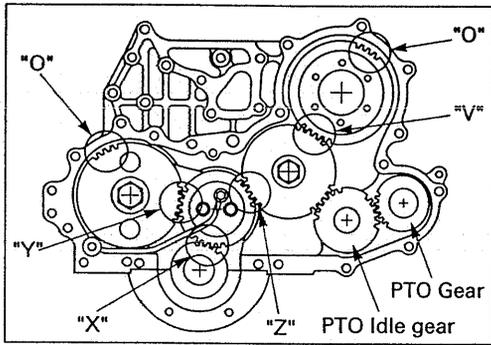

3. Idler Gear "B" and PTO Gear

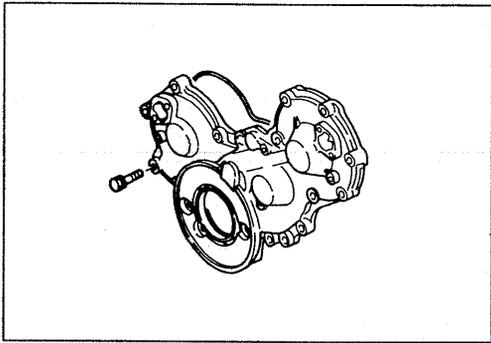

5. Timing Case Cover

- 1) Before installing the timing gear case, apply a 3 mm x 5 mm (0.12 in x 0.20 in) strip of sealant to the portion of the feather key indicated by the arrow in the illustration.
- 2) Check that the timing case cover O-ring is firmly inserted into the gear case groove.
- 3) Tighten the timing case cover bolts to the specified torque.



Timing Case Cover Bolt Torque kg-m(lb.ft/N-m)

M 8x1.25 (0.31x0.05) Bolt	1.4 – 2.4 (10 – 17/14 – 24)
------------------------------	-----------------------------

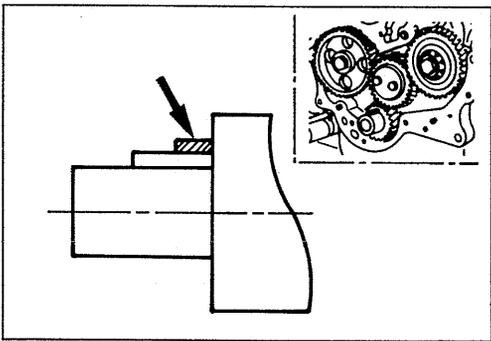

7. Crankshaft Damper Pulley

- 1) Block the flywheel ring gear with a piece of wood to prevent it from turning.
- 2) Tighten the crankshaft damper pulley to the specified torque.



Crankshaft Damper Pulley Bolt Torque kg-m(lb.ft/N-m)

20.1 – 24.5 (145 – 177/197 – 240)

Take care not to damage the crankshaft damper pulley boss.

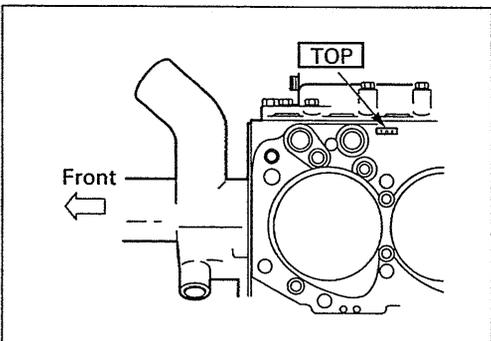

8. Cylinder Head Gasket

The cylinder gasket "TOP" mark must be facing up.
Use the head gasket of the thickness 1.65 mm.
(Part No. 897066-1970)



9. Cylinder Head



1) Align the cylinder body dowels and the cylinder head dowel holes.

Carefully set the cylinder head to the cylinder head gasket.



2) Apply engine oil to the cylinder head fixing bolt threads and setting faces.



3) Tighten the cylinder head bolts to the specified torque in two steps following the numerical order shown in the illustration.

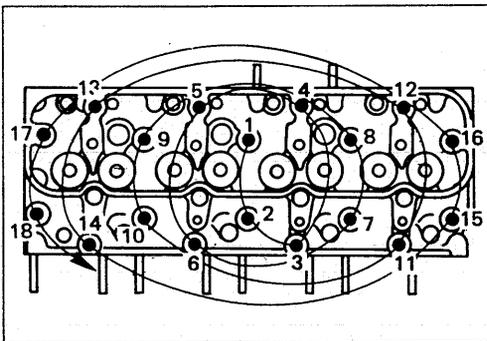

Cylinder Head Bolt Torque kg·m(lb.ft/N·m)

1st stop	2nd stop	3rd stop
4.5 – 5.5 (33 – 40/44 – 54)	60 – 75°	60 – 75°

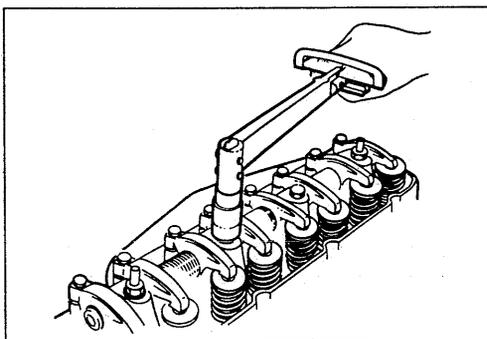

11. Rocker Arm Shaft and Rocker Arm

Tighten the rocker arm shaft bracket bolts in the numerical order shown in the illustration.

Rocker Arm Shaft Bracket Bolt Torque kg·m(lb.ft/N·m)

5.0 – 6.0 (36 – 43/49 – 59)

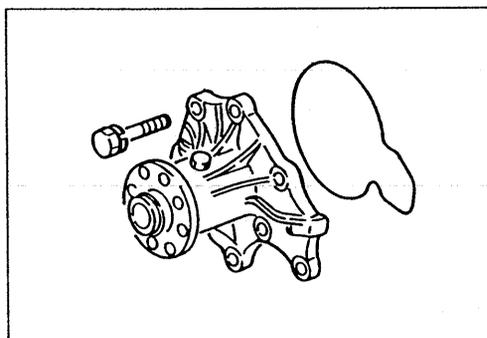

12. Water Pump

1) Temporarily tighten the water pump bolt marked with an arrow in the illustration.

This bolt will be tightened to the specified torque when the alternator adjusting plate is installed.

2) Tighten the other water pump bolts to the specified torque.

Water Pump Bolt Torque kg·m(lb.ft/N·m)

1.4 – 2.4 (10 – 17/14 – 24)

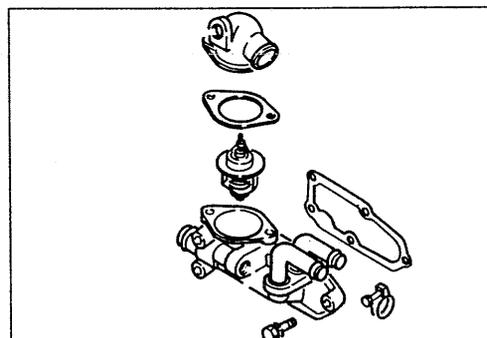

13. Thermostat Housing

1) Install the thermostat housing.

2) Tighten the thermostat housing bolts to the specified torque.

Thermostat Housing Bolt Torque kg·m(lb.ft/N·m)

1.4 – 2.4 (10 – 17/14 – 24)

15. Glow Plug and Glow Plug Connector



1) Tighten the glow plugs to the specified torque.

Glow Plug Torque	kg·m(lb.ft/N·m)
1.5 – 2.0 (11 – 14/15 – 20)	

2) Install the glow plug connectors.

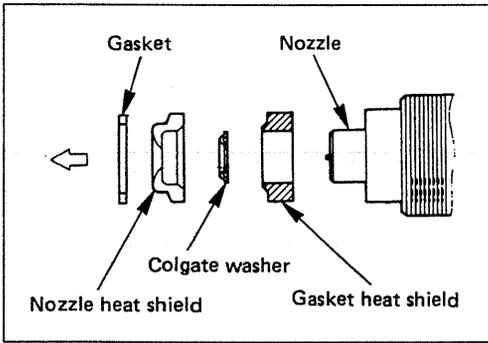

16. Injection Nozzle Holder

1) Install the heat shield washer and the heat shield to the cylinder head from the nozzle holder installation hole side. Lightly tap the flange into place with a brass bar.

The heat shield flange side must be facing up.

NOTE:

Always install a new heat shield. Never reuse the old heat shield.

2) Tighten the holder nut to the specified torque.

	kg·m(lb.ft/N·m)
6.0 – 7.0 (43 – 51/59 – 69)	

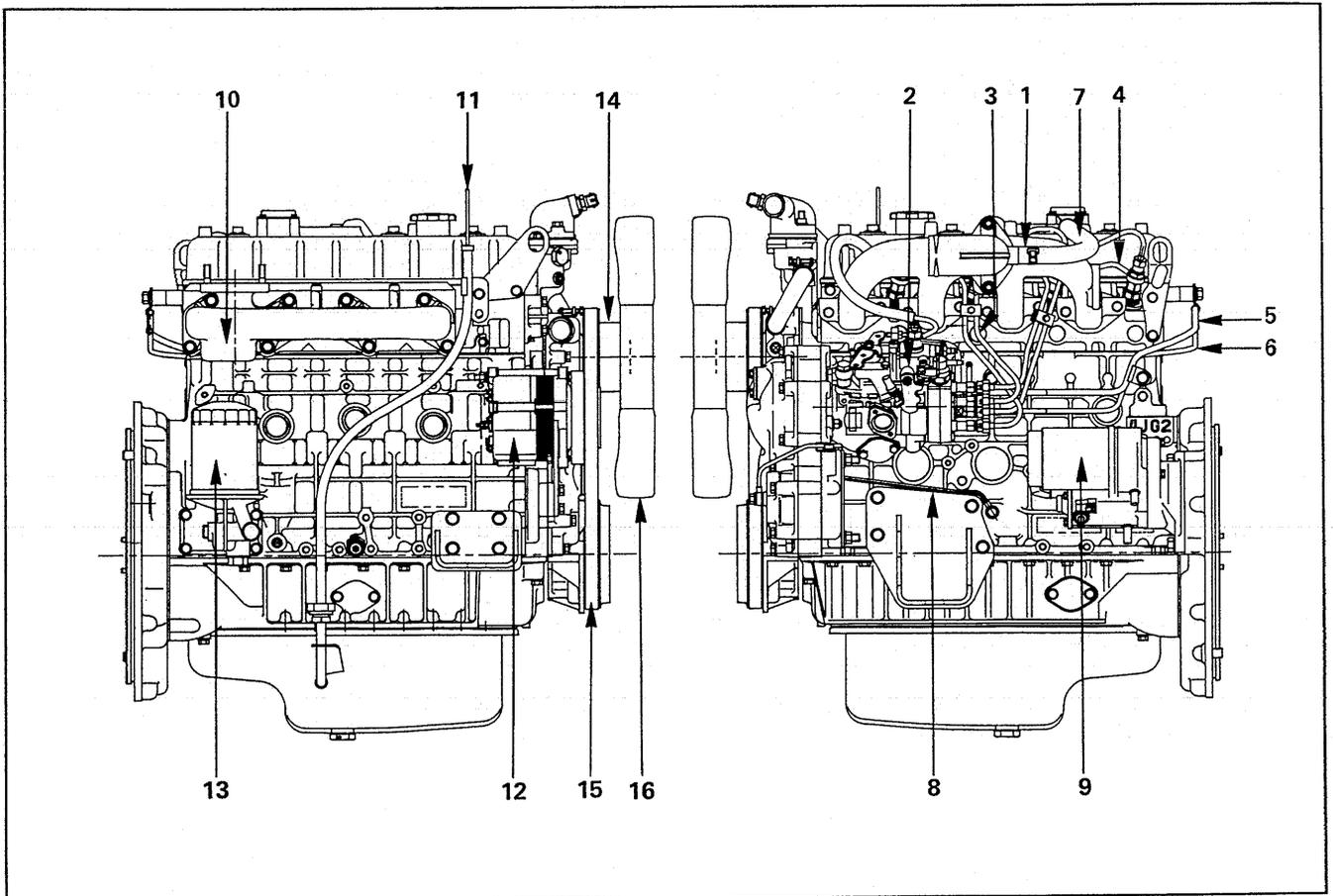

Reassembly Steps – 3

- | | |
|------------------------------------|-----------------------------|
| ▲ 1. Intake manifold | 11. Dipstick and guide tube |
| ▲ 2. Injection pump | ▲ 12. Alternator |
| ▲ 3. Fuel injection pipe with clip | ▲ 13. Oil filter |
| 4. Fuel leak off pipe | 14. Fan pulley |
| 5. Fuel pipe (IN) | 15. Cooling fan belt |
| 6. Fuel pipe (OUT) | 16. Cooling fan and spacer |
| 7. Breather hose | |
| 8. Oil pipe | |
| ▲ 9. Starter motor | |
| ▲ 10. Exhaust manifold | |



Important Operations (Reassembly Steps-3)

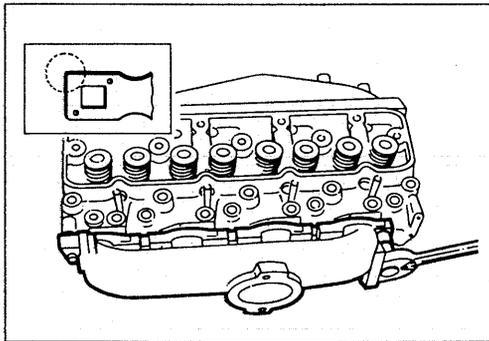

1. Intake Manifold

Install the intake manifold gasket with the end having the sharp corners facing the front of the engine.

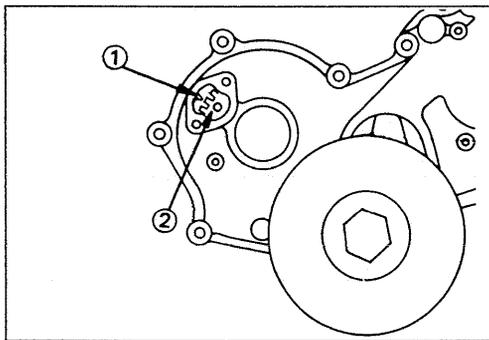

2. Injection Pump Installation

1) Turn the crankshaft slowly clockwise to align the camshaft timing check hole pointer ① with the camshaft timing gear "O" mark ② .

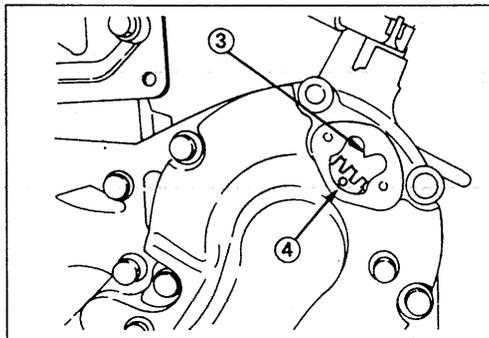

2) Install the injection pump to the timing gear case.

Align the injection pump timing check hole pointer ③ with the timing gear "O" mark ④ .

3) Tighten the injection pump bracket bolt ⑤ to the specified torque.

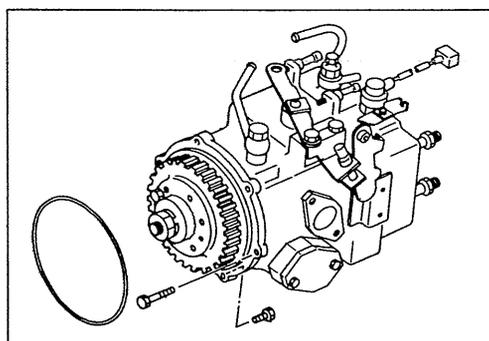

Injection Pump Bracket Bolt Torque kg·m(lb.ft/N·m)

1.4 -2.4 (10 - 1714 - 24)

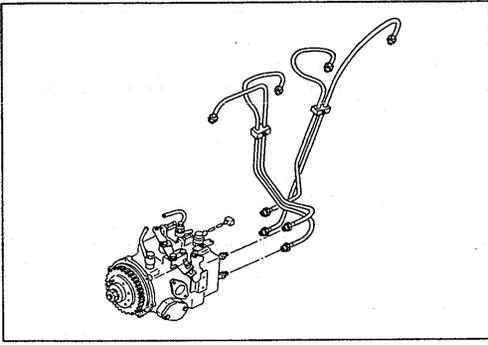

3. Fuel Injection Pipe with Clip

- 1) Temporarily tighten the injection pipe sleeve nut.
- 2) Set the clip in the prescribed position.

Note:

Make absolutely sure that the clip is correctly positioned. An improperly positioned clip will result in injection pipe breakage and fuel pulsing noise.



- 3) Tighten the injection pipe sleeve nut to the specified torque.

Injection Pipe Sleeve Nut Torque	kg·m(lb.ft/N·m)
2.0 – 4.0(14 – 29/20 – 39)	

9. Starter motor

Tighten the starter bolts to the specified torque.

Starter Bolt Torque	kg·m(lb.ft/N·m)
6.7 – 8.7 (48 – 63/60 – 85)	

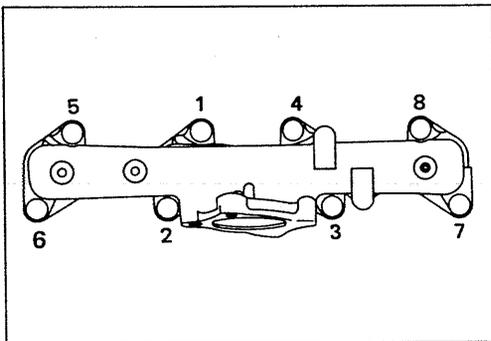

10. Exhaust Manifold

Tighten the exhaust manifold bolts to the specified torque a little at a time in the numerical order shown in the illustration.

Exhaust Manifold Bolt Torque	kg·m(lb.ft/N·m)
1.4 – 2.4 (10 – 17/14 – 24)	

12. Alternator and Adjusting Plate



Tighten the alternator bolts and the adjusting plate bolts to the specified torque.

Alternator Bolt Torque	kg·m(lb.ft/N·m)
1.4 – 2.4 (10 – 17/14 – 24)	



Tighten the adjusting plate bolts to the specified torque after cooling drive belt installation.

Adjusting Plate Bolt Torque	kg·m(lb.ft/N·m)
1.4 – 2.4 (10 – 17/14 – 24)	

13. Oil Filter

Tighten the oil filter bolts to the specified torque.



Oil Filter Bolt Torque kg·m(lb.ft/N·m)

1.4 – 2.4 (10 – 17/14 – 24)

SECTION 6
LUBRICATING SYSTEM

TABLE OF CONTENTS

ITEM	PAGE
Main data and specifications	114
General description	115
Oil pump	118
Oil filter with built-in oil cooler	121

MAIN DATA AND SPECIFICATIONS

Item	4JG2
Oil pump type	Trochoid
Delivery volume Lit(US/UK gal)/min.	17.5 (4.61/3.85)
Pump speed rpm	1000
Delivery pressure kg/cm ² (psi/kPa)	4.0 (57/392)
Oil temperature °C(°F)	47 – 53 (116.6 – 127.4)
Engine oil	SAE 30
Oil filter type	Full flow with cartridge paper element
Relief valve opening pressure kg/cm ² (psi/kPa)	4.3 – 4.7 (61 – 67/422 – 461)
Safety valve opening pressure kg/cm ² (psi/kPa)	0.8 – 1.2 (11 – 17/78 – 118)
Oil cooler type (if so equipped)	Water-cooled
Safety valve opening pressure kg/cm ² (psi/kPa)	2.3 – 2.7 (33 – 38/225 – 265)

GENERAL DESCRIPTION

LUBRICATING OIL FLOW

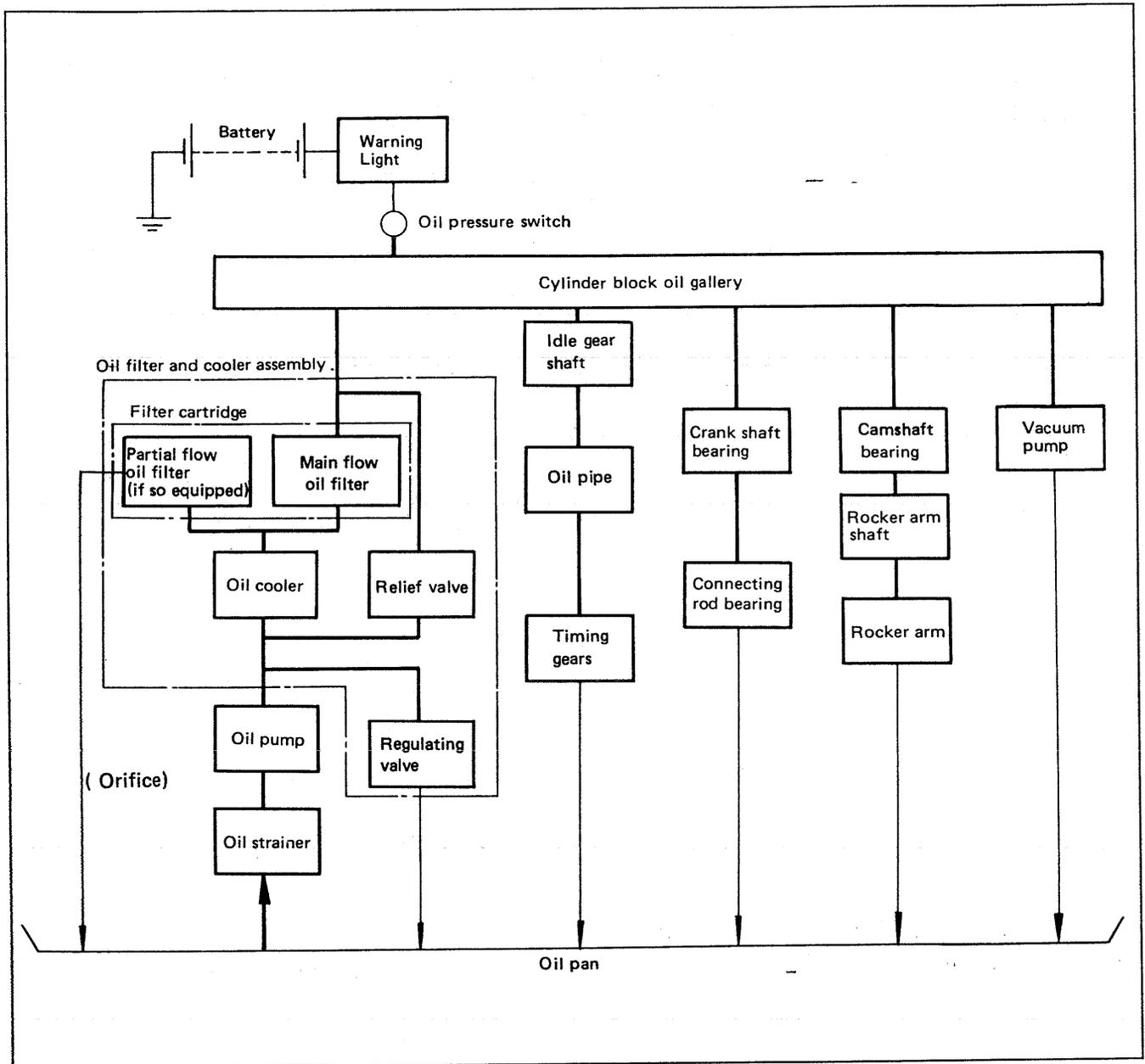

The 4J Series engine lubricating system is a full flow type.

Lubricating oil is pumped from the oil pump to the cylinder body oil gallery through the oil cooler and the oil filter. It is then delivered to the vital parts of the engine from the cylinder body oil gallery.

OIL PUMP

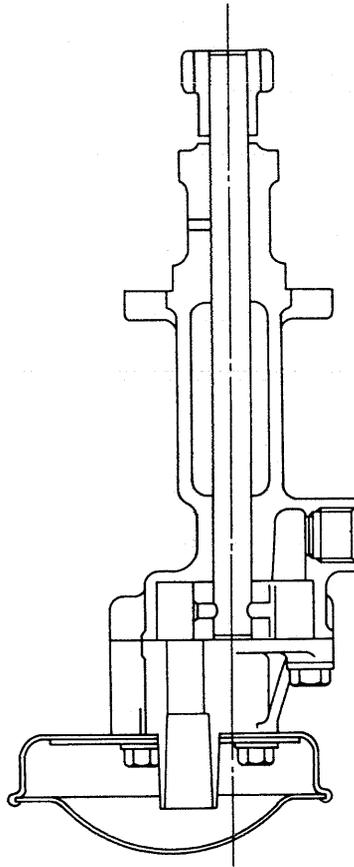

4J Series engine are equipped with a trochoid type oil pump.

The oil filter and the water cooled oil cooler are a single unit to increase the cooling effect.

MAIN OIL FILTER

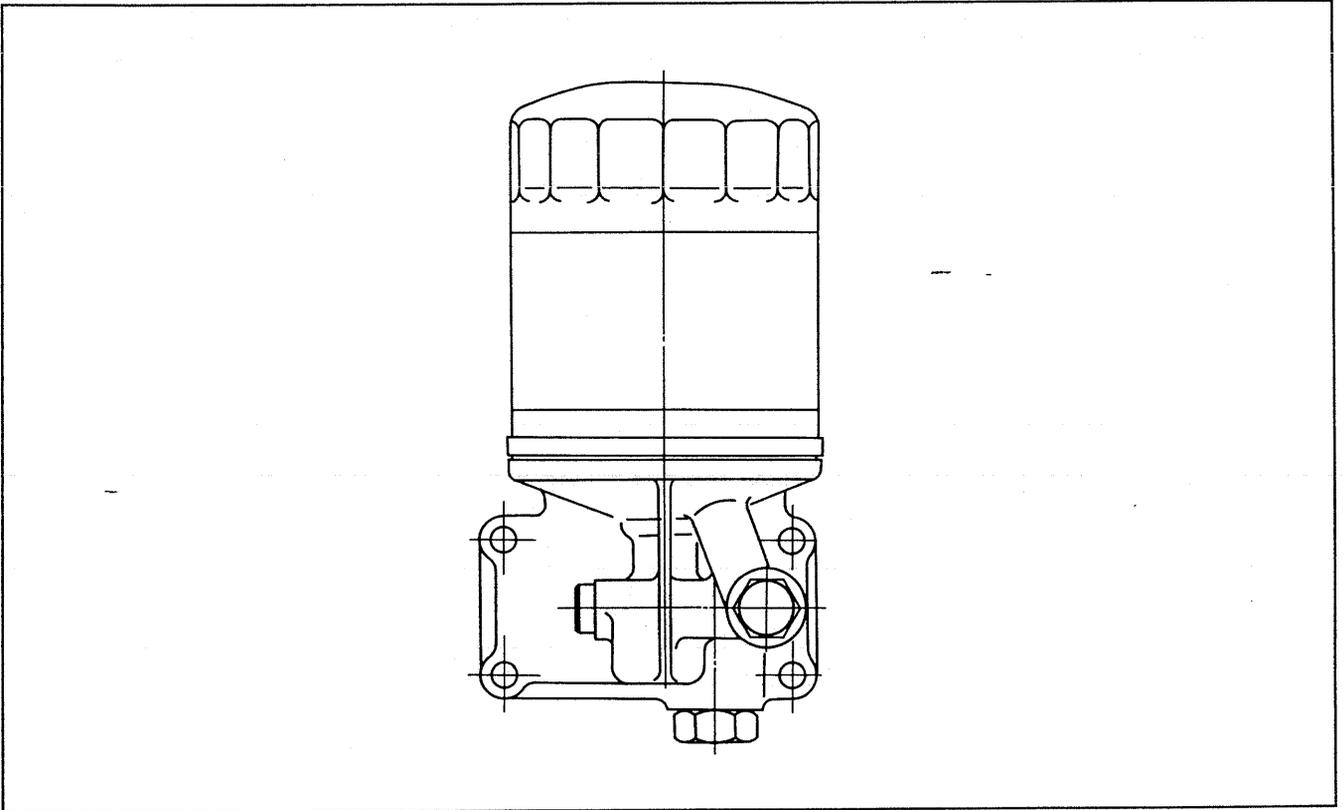

OIL FILTER WITH BUILT-IN OIL COOLER (Option)

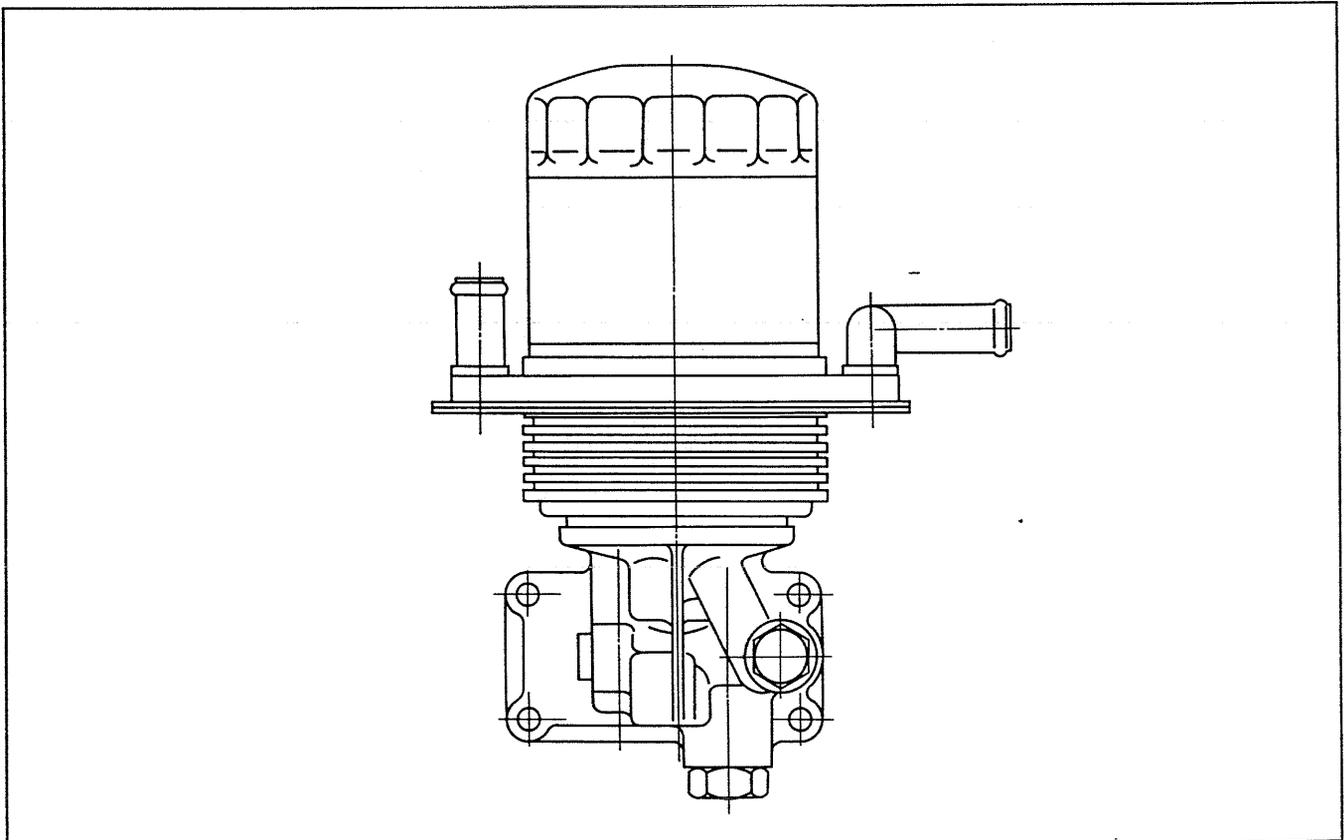

OIL PUMP



DISASSEMBLY

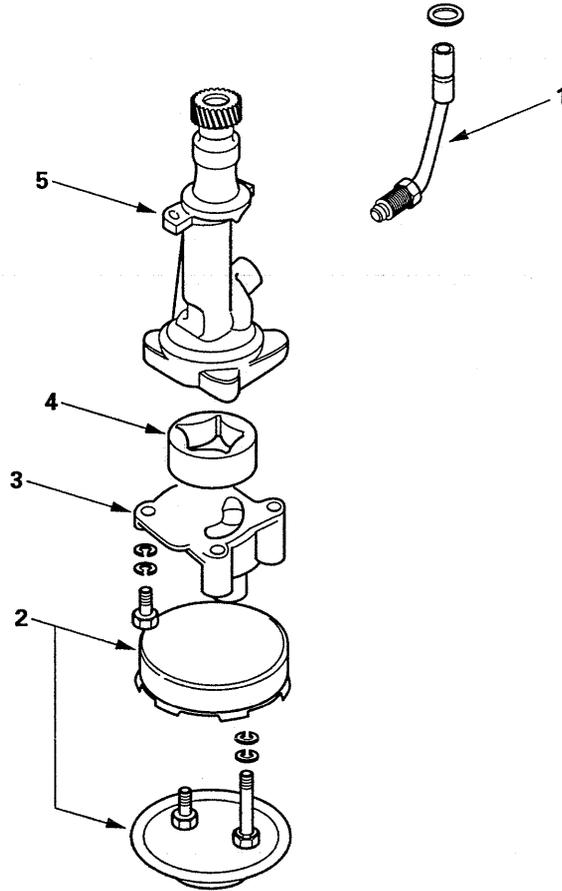

051ET001

Disassembly Steps

1. Oil pipe
2. Strainer case
3. Pump cover

4. Vane
- ▲ 5. Pump body with rotor and pinion



INSPECTION AND REPAIR

Make the necessary adjustments, repairs, and part replacements if excessive wear or damage is discovered during inspection.

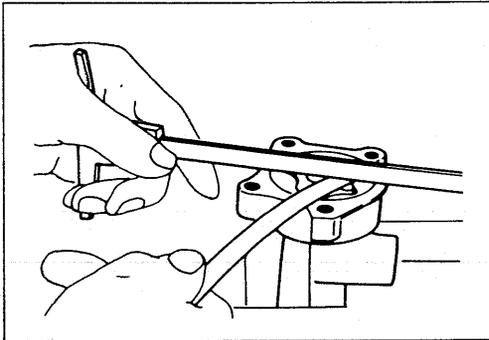

Vane, Rotor, and Cover Clearance

Use a feeler gauge to measure the clearance between the vane, the rotor, and the cover.

If the clearance between the vane, the rotor, and the cover exceeds the specified limit, the rotor set (pin, shaft, rotor, and vane) must be replaced.

Vane, Rotor, and Cover Clearance mm(in)

Standard	Limit
0.02 – 0.07 (0.0008 – 0.0026)	0.15 (0.006)

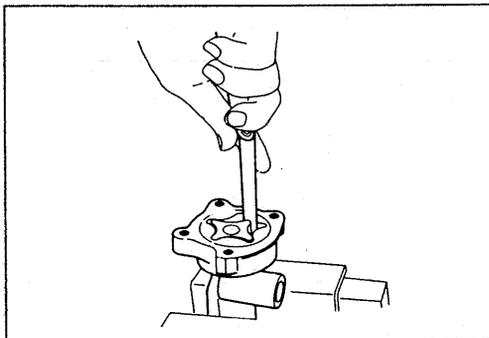

Rotor and Vane Clearance

Use a feeler gauge to measure the clearance between the rotor and the vane.

If the clearance between the rotor and the vane exceeds the specified limit, the rotor kit (shaft, rotor, and vane) must be replaced.

Rotor and Vane Clearance mm(in)

Standard	Limit
0.14 (0.006) or less	0.20 (0.008)

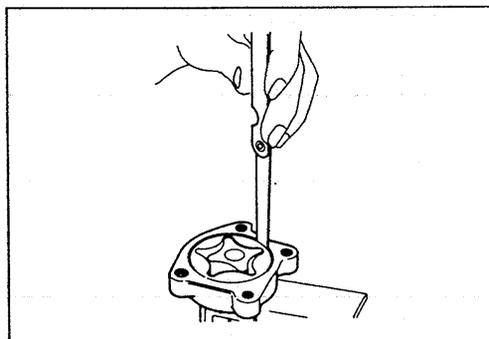

Vane and Pump Body Clearance

Use a feeler gauge to measure the clearance between the vane and the pump body.

If the clearance between the vane and the pump body exceeds the specified limit, the entire pump assembly must be replaced.

Vane and Pump Body Clearance mm(in)

Standard	Limit
0.20 – 0.27 (0.008 – 0.011)	0.40 (0.016)



REASSEMBLY

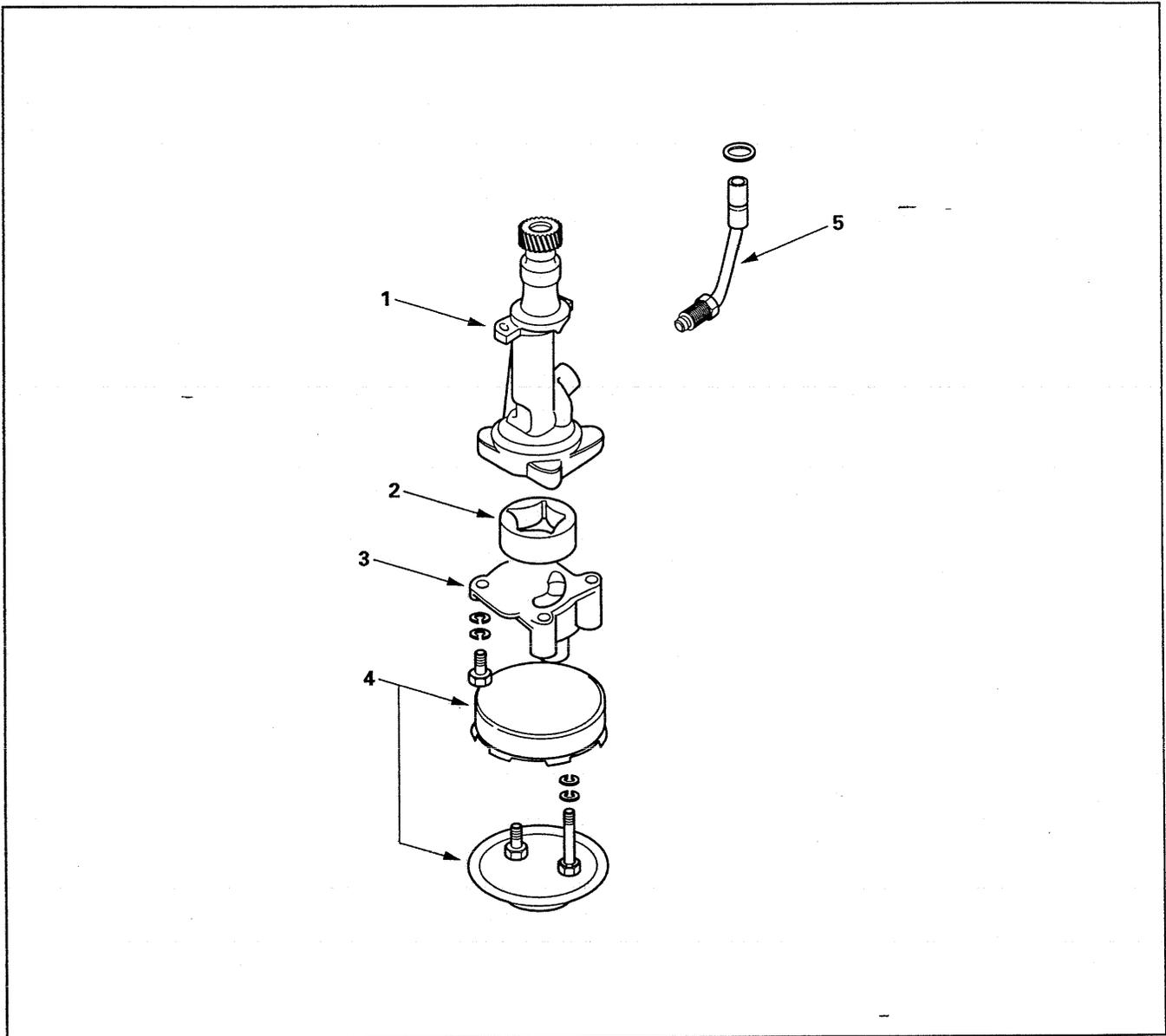

051ET002

Reassembly Steps

- 1. Pump body with rotor and pinion
- 2. Vane
- 3. Pump cover

- 4. Strainer case
- 5. Oil pipe

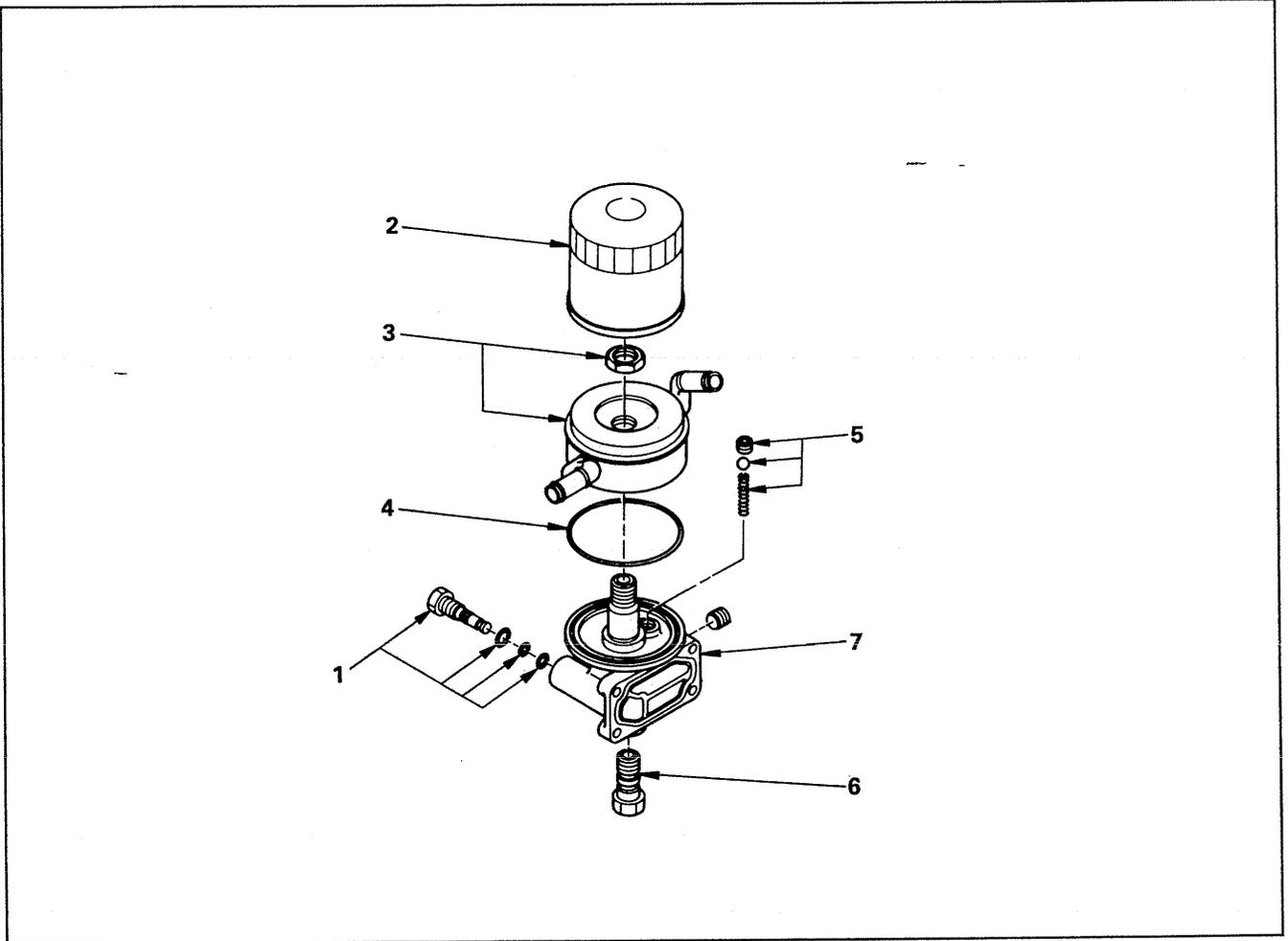
OIL FILTER WITH BUILT-IN OIL COOLER (Option)**DISASSEMBLY****Disassembly Steps**

1. Drain plug
2. Cartridge oil filter
3. Oil cooler
4. O-ring

5. Safety valve
6. Relief valve
7. Oil filter body



INSPECTION AND REPAIR

Make the necessary adjustments, repairs, and part replacements if excessive wear or damage is discovered during inspection.

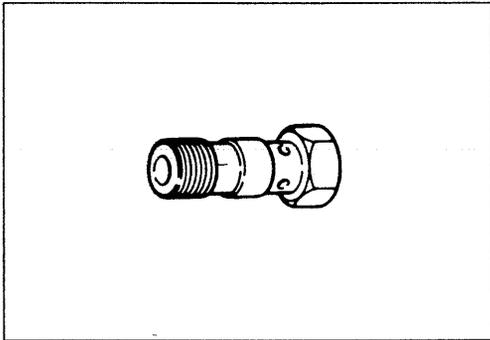

Relief Valve

1. Attach an oil pressure gauge to the oil gallery near the oil filter.
2. Start the engine to check the relief valve opening pressure.

Relief Valve Opening Pressure	kg/cm ² (psi/kPa)
5.8 – 6.2 (82 – 88/569 – 608)	

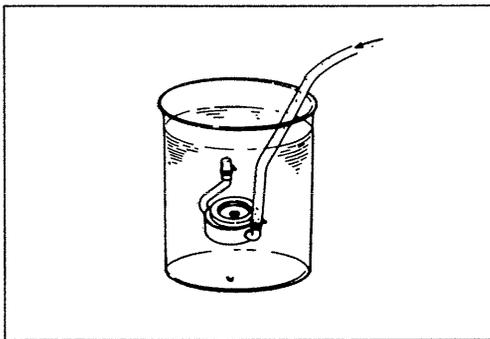

Oil Cooler

Water Leakage At Water Passage

1. Plug one side of the oil cooler water passage.
2. Submerge the oil cooler in water.
3. Apply compressed air (2 kg/cm² (28 psi/196 kPa)) to the other side of the oil cooler water passage.

If air bubbles rise to the surface, there is water leakage.

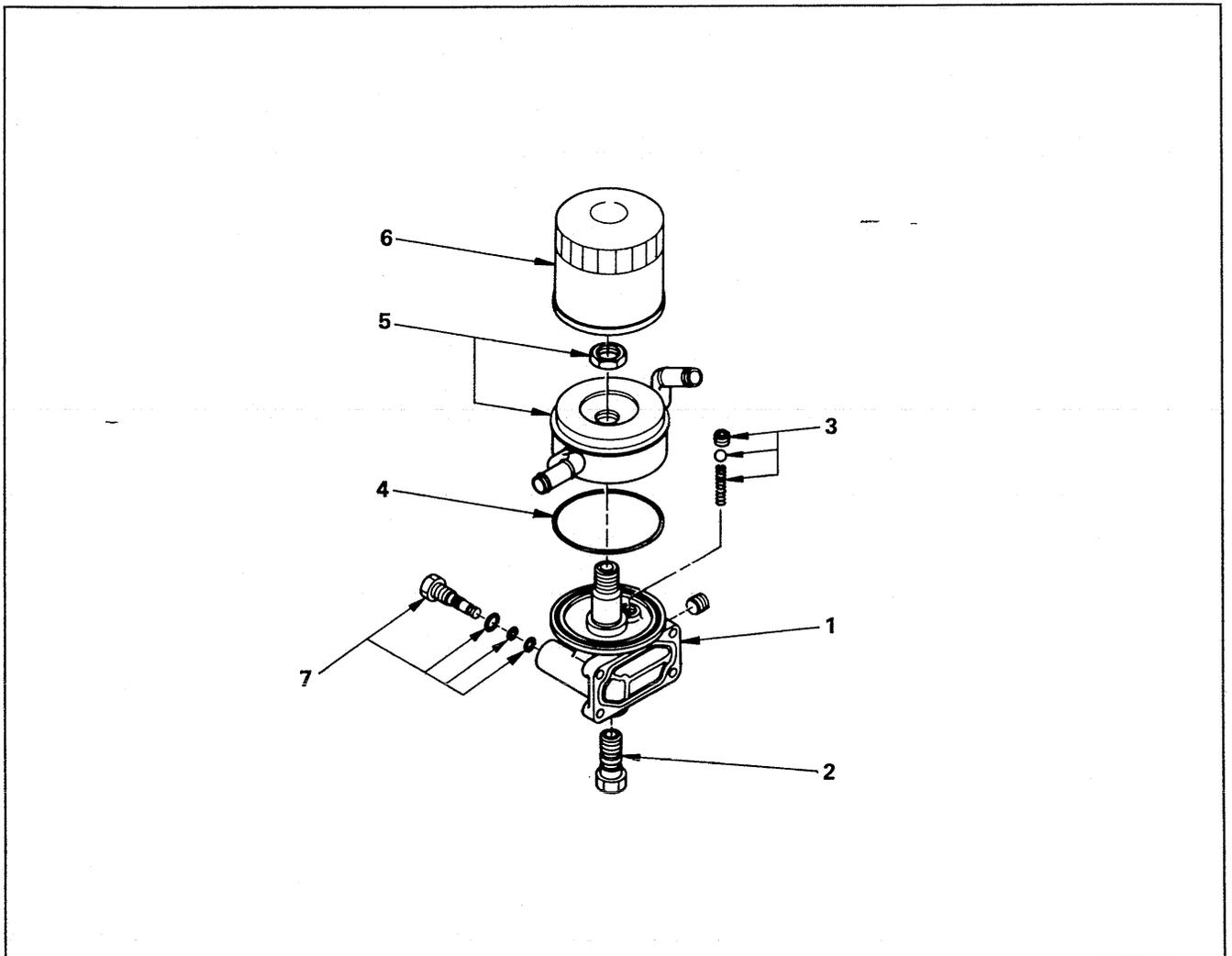

REASSEMBLY

**Reassembly Steps**

- | | |
|--------------------|---------------------------|
| 1. Oil filter body | ▲ 5. Oil cooler |
| ▲ 2. Relief valve | ▲ 6. Oil filter cartridge |
| ▲ 3. Safety valve | ▲ 7. Drain plug |
| 4. O-ring | |



Important Operations

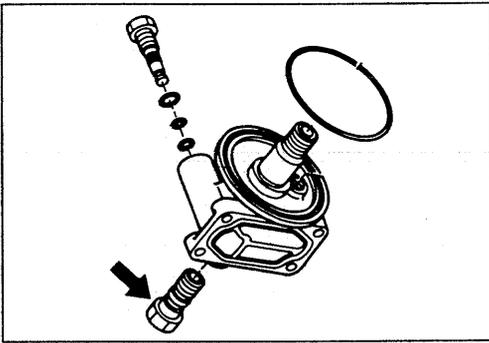

2. Relief Valve

Tighten the relief valve to the specified torque.



Relief Valve Torque kg·m(lb.ft/N·m)

2.5 – 3.5 (18 – 25/25 – 34)

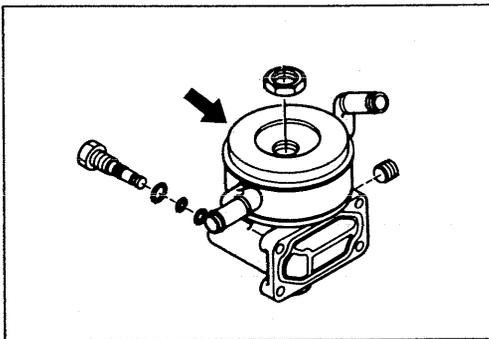

5. Oil Cooler

1) Align the oil filter holes with the body knock pins at installation.

2) Tighten the oil cooler to the specified torque.



Oil Cooler Torque kg·m(lb.ft/N·m)

2.5 – 3.5 (18 – 25/25 – 34)

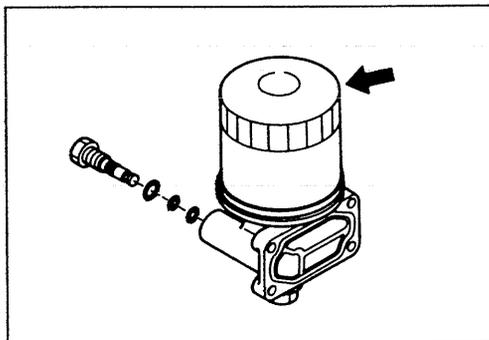

6. Oil Filter Cartridge

1) Apply engine oil to the O-ring.

2) Turn in the cartridge oil filter until the filter sealing face makes contact with the O-ring.

3) Turn in the cartridge oil filter an additional 1 and 1/4 of a turn.

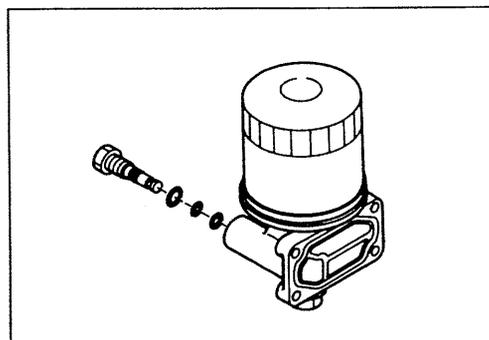

7. Drain Plug

Tighten the drain plug to the specified torque.



Drain Plug Torque kg·m(lb.ft/N·m)

1.0 – 2.0 (7.2 – 14/9.8 – 20)

SECTION 7

COOLING SYSTEM

TABLE OF CONTENTS

ITEM	PAGE
Main data and specifications	126
General description	127
Water pump	129
Thermostat	134

MAIN DATA AND SPECIFICATIONS

Item	
Water pump type	Centrifugal impeller
Pump to crankshaft speed ratio (To 1)	1.1
Delivery volume Lit(US/UK gal)/min.	100 (26.3/22.2)
Pump speed at 3000 rpm	
Water temperature at 30°C (86°F)	
Pump bearing type	Double row shaft
Thermostat type	Wax pellet with jiggle valve
Valve initial opening temperature °C(°F)	76.5 (170)
Valve full opening temperature °C(°F)	90 (194)
Valve lift at fully open position mm(in.)	8.0 (0.31)

GENERAL DESCRIPTION

COOLANT FLOW

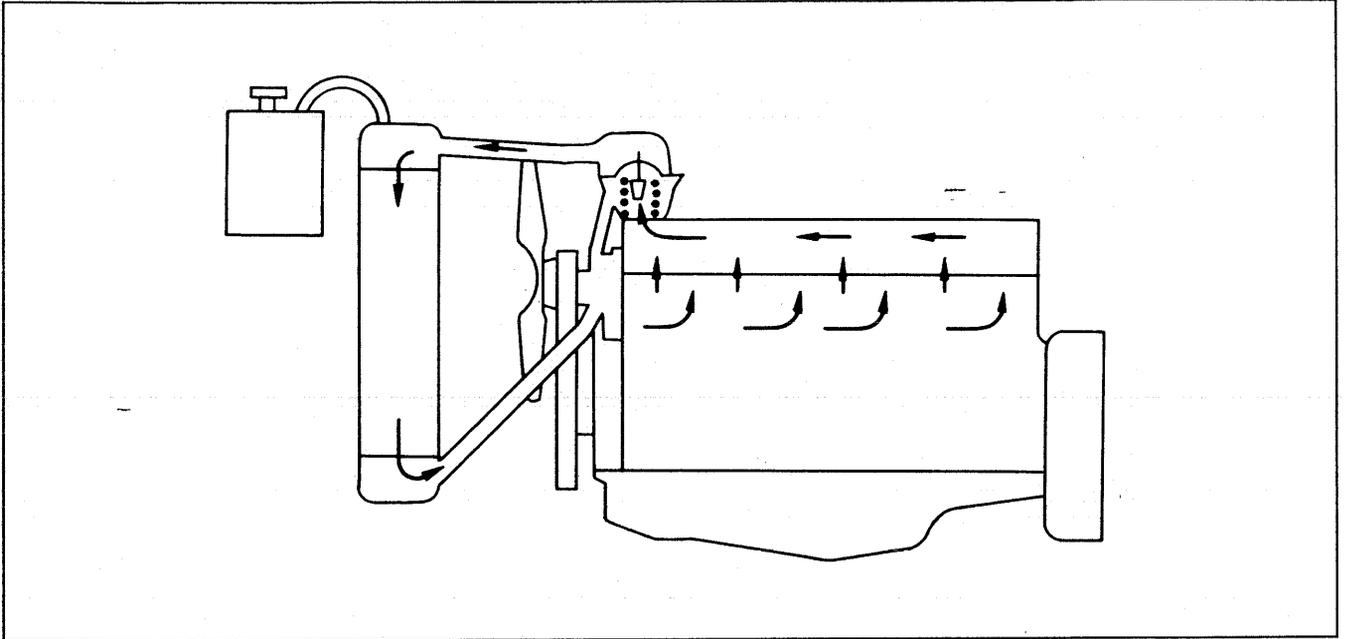

The engine cooling system consists of the radiator, the water pump, the cooling fan, and the thermostat.

To quickly increase cold engine coolant temperature for smooth engine operation, the coolant is circulated by the water pump and thermostat through the by-pass hose and back to the cylinder body. The coolant does not circulate through the radiator.

When the coolant temperature reaches 76.5°C (170°F), the thermostat will begin to open and a gradually increasing amount of coolant will circulate through the radiator.

The thermostat will be fully open when the coolant temperature reaches 90°C (194°F). All of the coolant is now circulating through the radiator for effective engine coolant.

COOLING SYSTEM

WATER PUMP

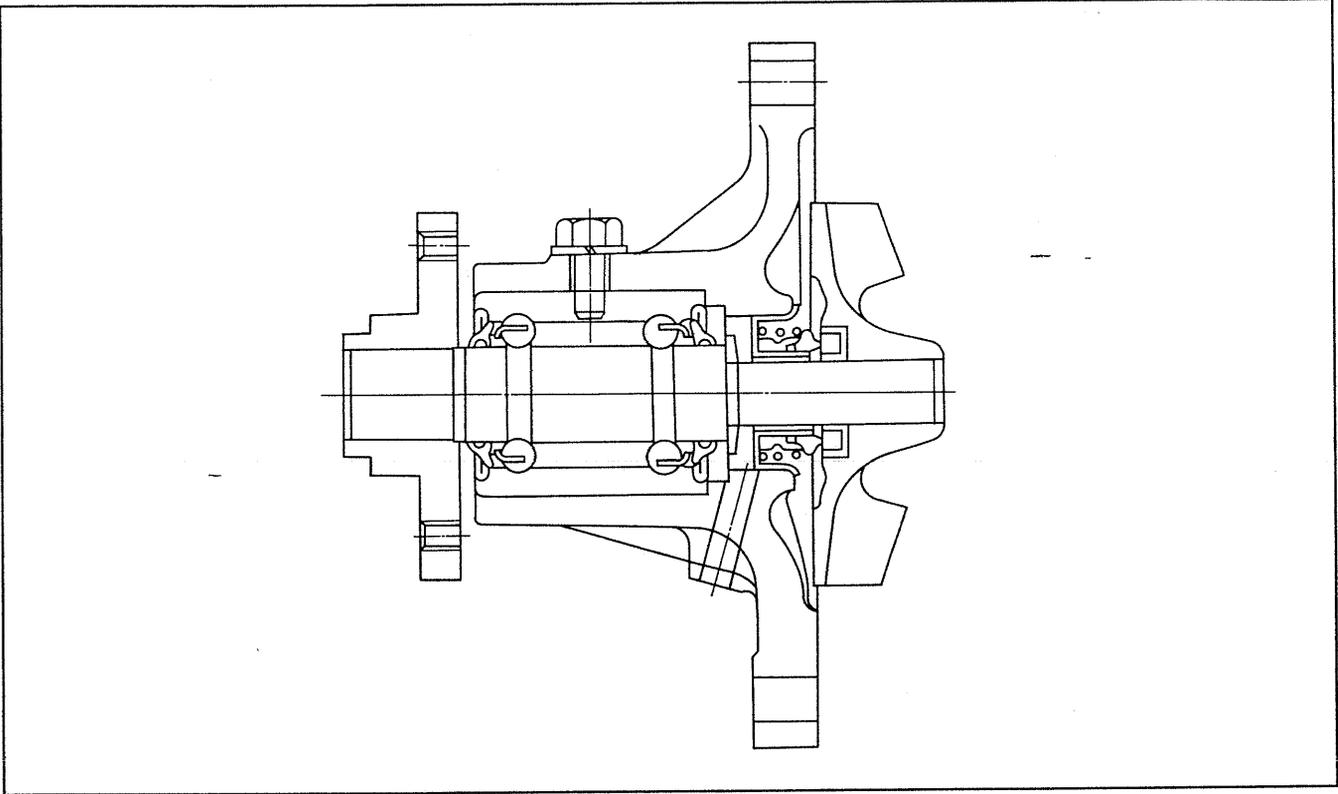

THERMOSTAT

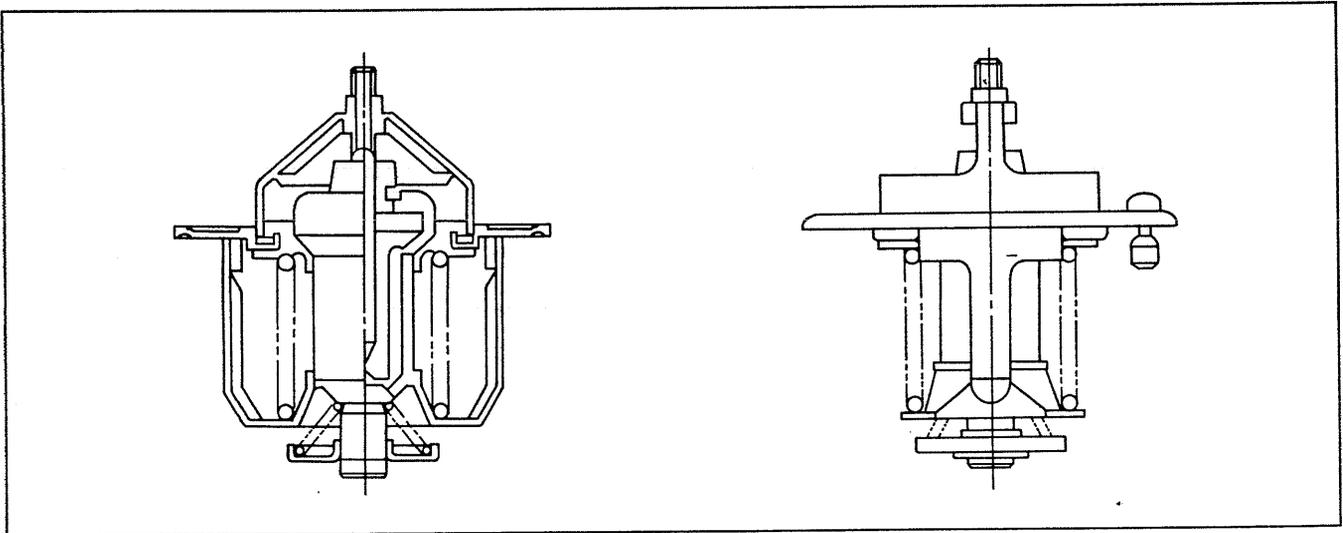

A centrifugal type water pump forcefully circulates the coolant through the cooling system.

A wax pellet type thermostat is used.

The jiggle valve accelerates engine warm-up.

WATER PUMP

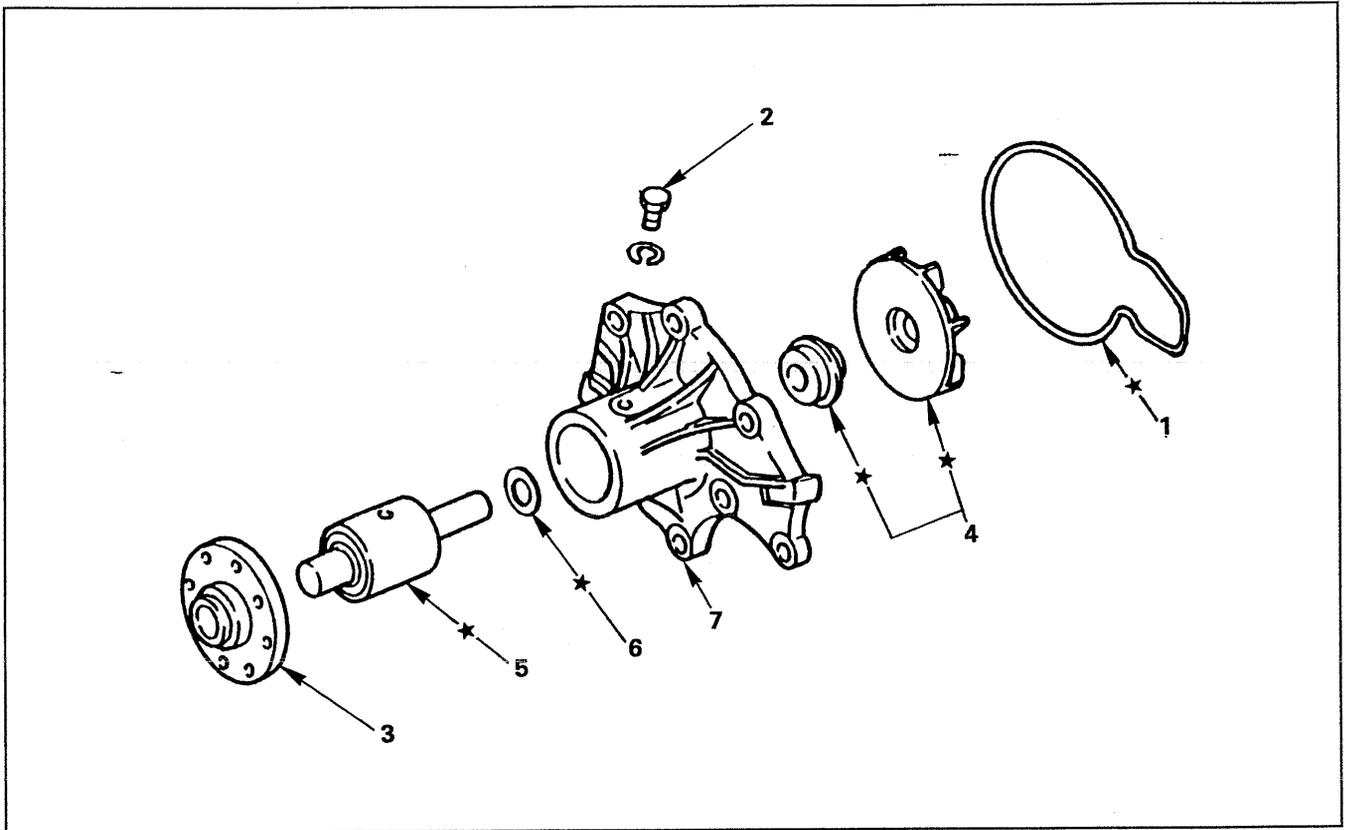
**DISASSEMBLY****Disassembly Steps**

- ▲ 1. O-ring
- ▲ 2. Set screw
- ▲ 3. Cooling fan center
- ▲ 4. Impeller and seal unit
- ▲ 5. Bearing unit
- ▲ 6. Thrower
- ▲ 7. Water pump body



Important Operations

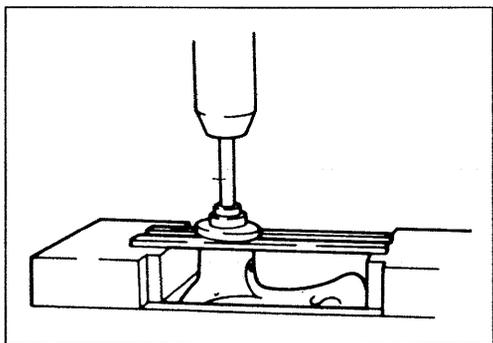

3. Cooling Fan Center

Remove the fan center with a bench press and a bar.

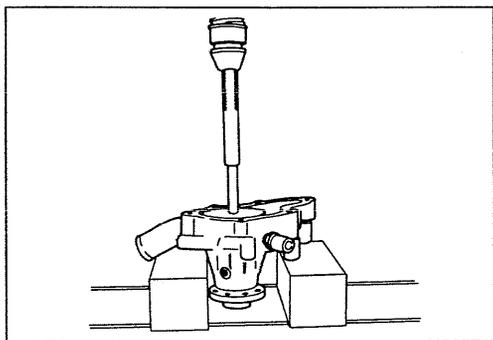

4. Impeller and Seal Unit

Remove the impeller and seal unit with a bench press and bar.

Note:

Do not drive out the impeller with a hammer. Damage to the impeller will result.



INSPECTION AND REPAIR

Make the necessary adjustments, repairs, and part replacements if excessive wear or damage is discovered during inspection.

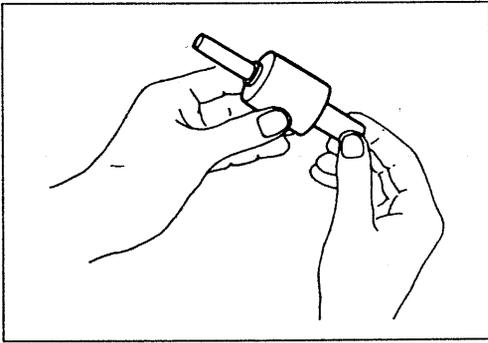

Bearing Unit

Check the bearing for abnormal noise, binding, and other abnormal conditions.



REASSEMBLY

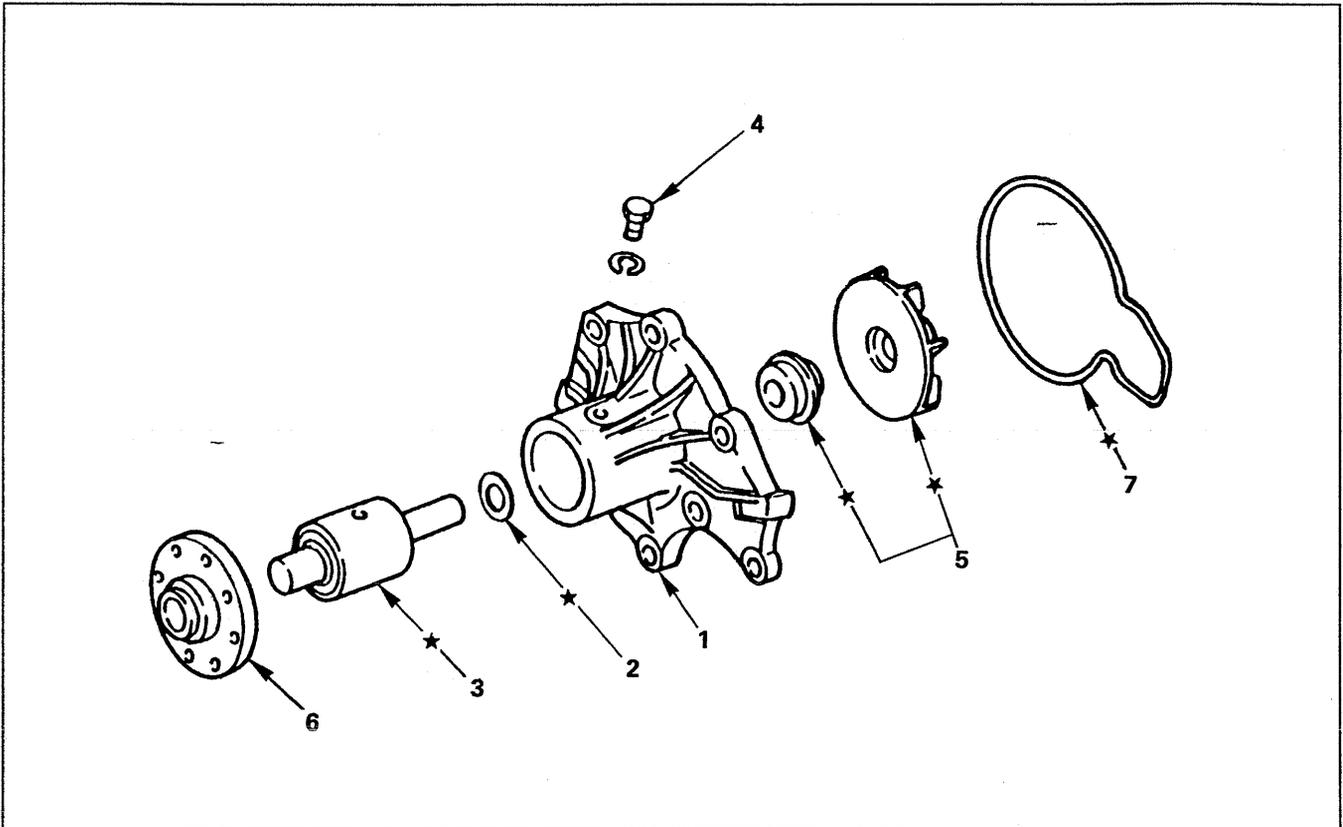

Reassembly Steps

- 1. Water pump body
- 2. Thrower
- ▲ 3. Bearing unit
- ▲ 4. Set screw
- ▲ 5. Impeller and seal unit
- ▲ 6. Cooling fan center
- 7. O-ring



Important Operations

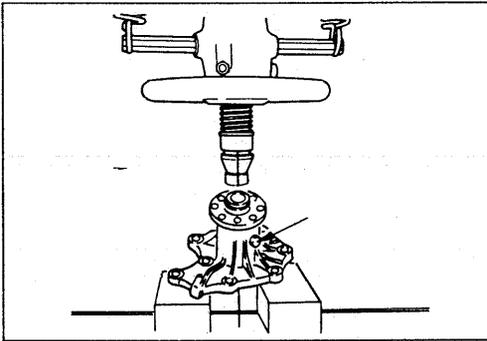

3. Bearing Unit

4. Set Screw

- 1) Align the bearing set screw hole with the pump body set screw hole.
- 2) Press the bearing unit into place.
- 3) Secure the bearing with the set screw.

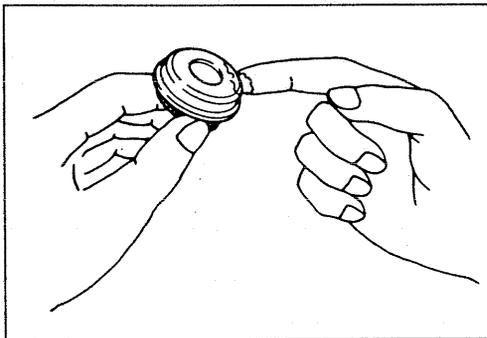

5. Impeller and Seal Unit

- 1) Apply a thin coat of liquid gasket to the seal unit outer periphery.
- 2) Install the seal unit.

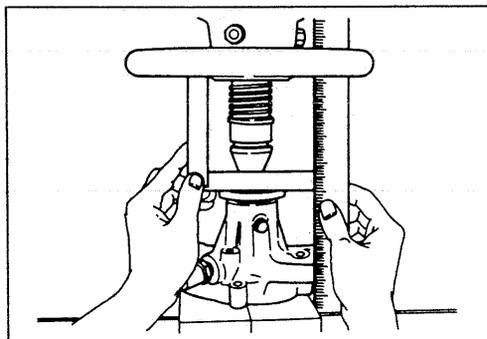

Note:

1. The fan center and the impeller are installed to the water pump shaft with a press.

Never attempt to remove and reinstall the fan center and the impeller a second time. Replace the entire water pump assembly.

Removing and reinstalling the fan center and the impeller a second time may result in the breakdown of the water pump during engine operation and subsequent serious overheating problems.

2. The water pump assembly must be replaced whenever the fan center and impeller pressure force falls below 200 kg.
3. Do not attempt to strike the bearing into position with a hammer or similar object. Damage to the bearing will result.

THERMOSTAT



INSPECTION AND REPAIR

Make the necessary adjustments, repairs, and part replacements if excessive wear or damage is discovered during inspection.

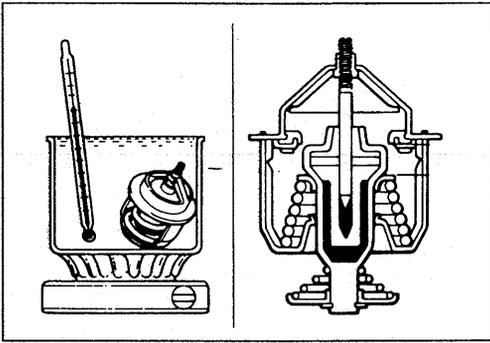

Operating Test

1. Completely submerge the thermostat in water.
2. Heat the water.

Stir the water constantly to avoid direct heat being applied to the thermostat.

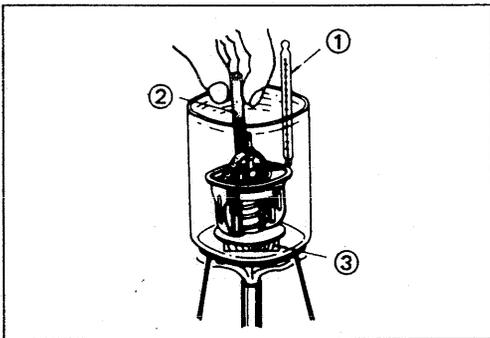

3. Check the thermostat initial opening temperature.

Thermostat Initial Opening Temperature °C(°F)

76.5 (170)



4. Check the thermostat full opening temperature.

Thermostat Full Opening Temperature °C(°F)

90 (194)



Valve Lift at Fully Open Position

mm(in.)

8.0 (0.31)

- ① Thermostat
- ② Agitating Rod
- ③ Wooden Piece

SECTION 8

FUEL SYSTEM

TABLE OF CONTENTS

ITEM	PAGE
General description	136
Injection nozzle	137
Injection pump data	144

GENERAL DESCRIPTION

FUEL FLOW

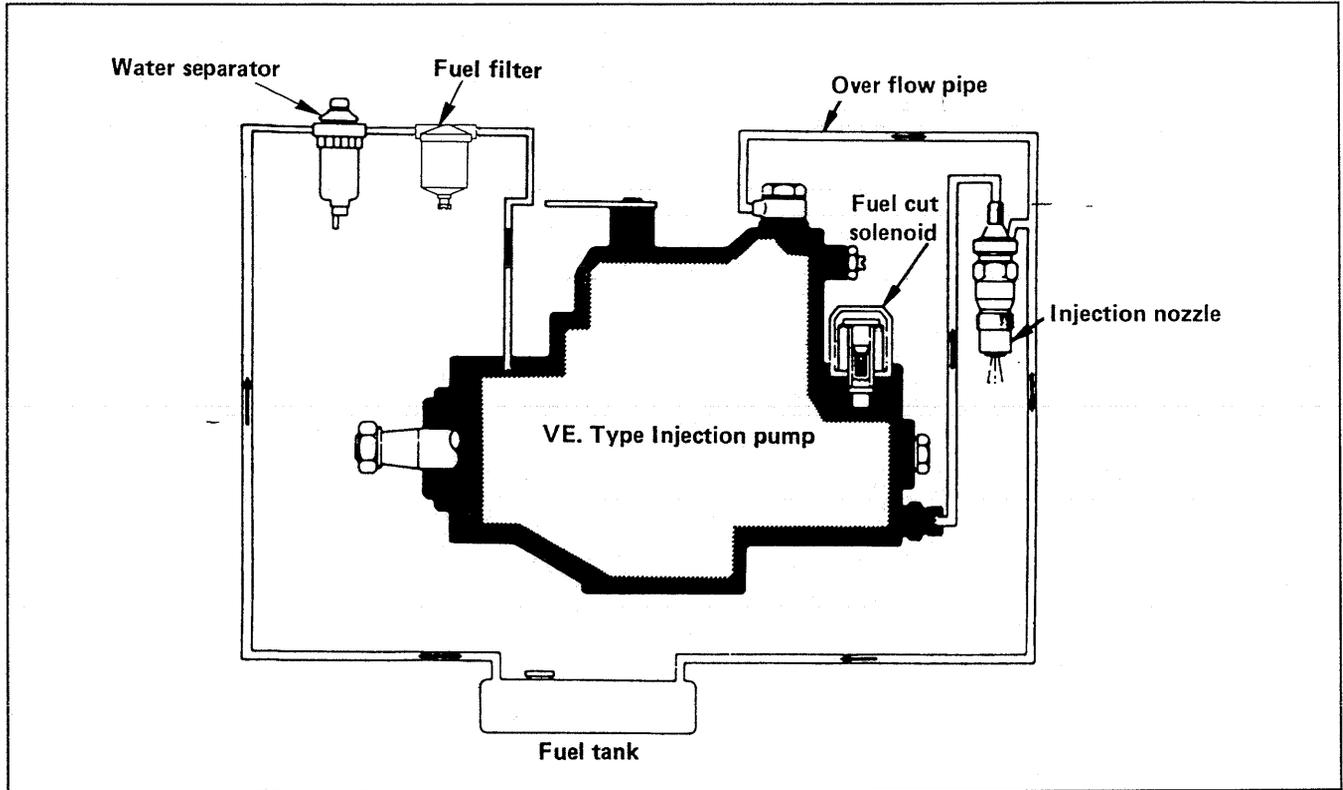

The fuel system consists of the fuel tank, the water separator (if so equipped), the fuel filter, the injection pump, and the injection nozzle.

The fuel from the fuel tank passes through the water separator and the fuel filter where water particles and other foreign material are removed from the fuel.

Fuel, fed by the injection pump plunger, is delivered to the injection nozzle in the measured volume at the optimum timing for efficient engine operation.

INJECTION NOZZLE

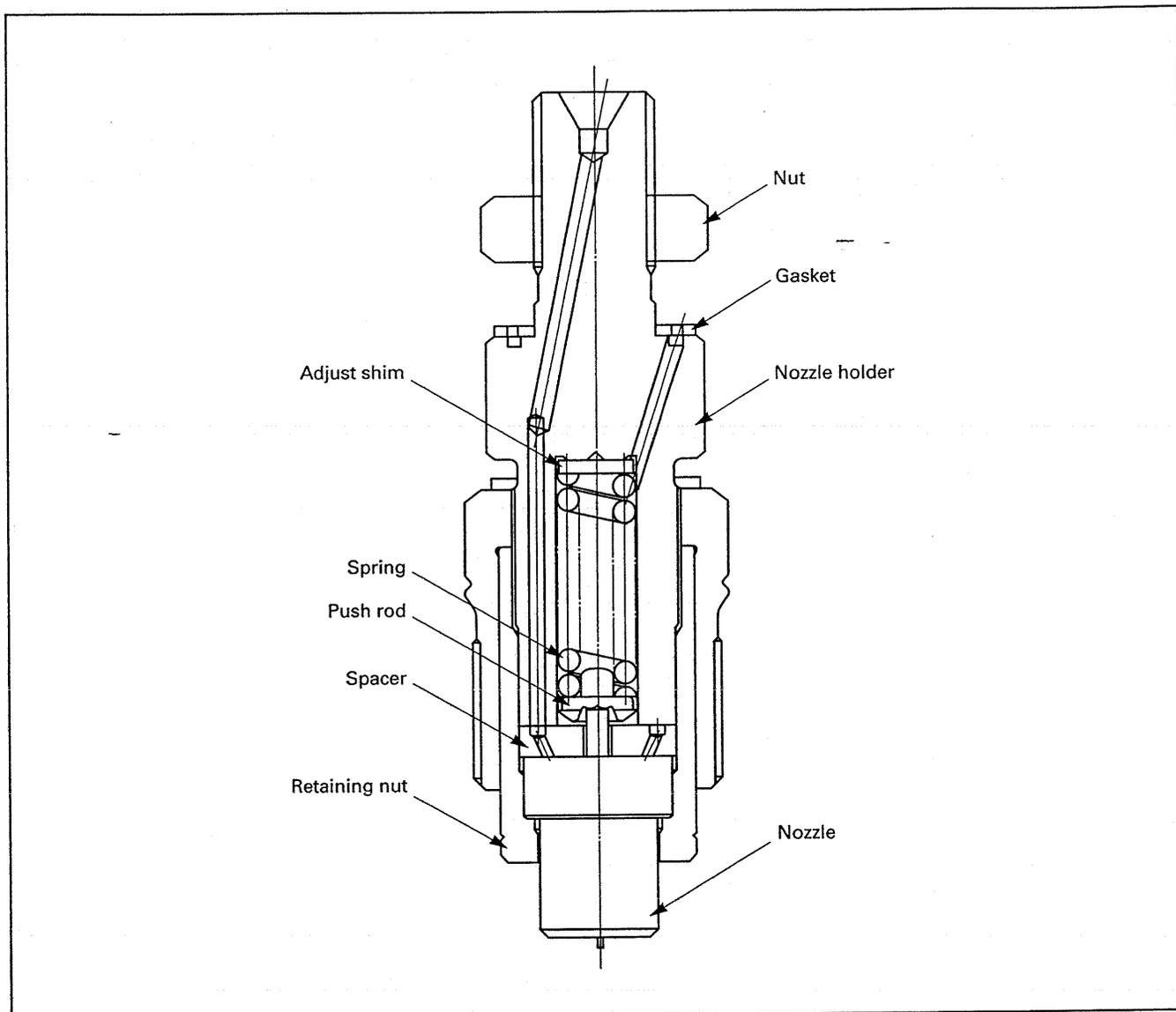

080ET002

The injection nozzle sprays pressurized fuel from the injection pump through the injection nozzle orifices and into the combustion chamber.

FUEL FILTER AND WATER SEPARATOR

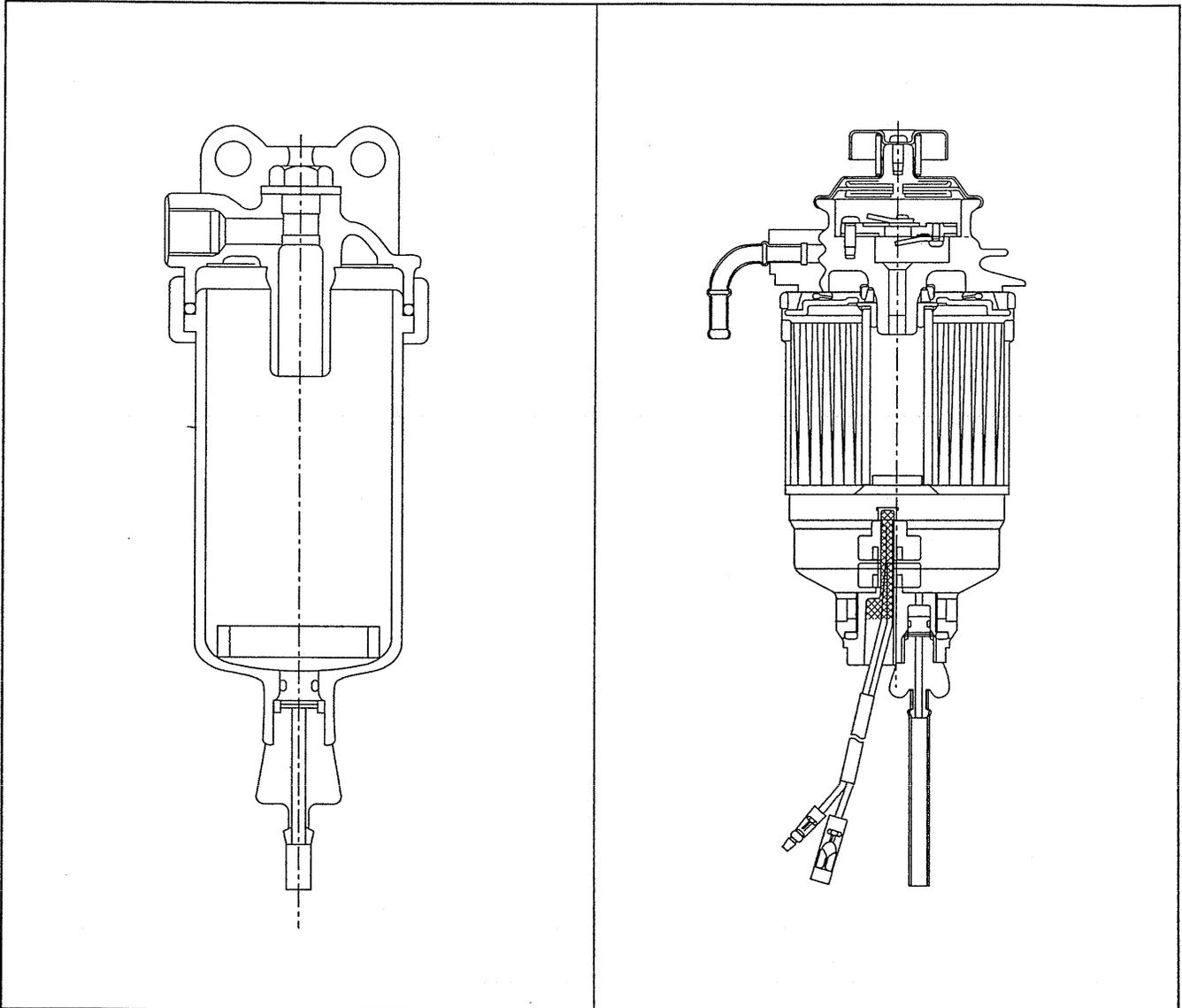

A cartridge type fuel filter and a water separator are used.

As the inside of the injection pump is lubricated by the fuel which it is pumping, the fuel must be perfectly clean. The fuel filter and the water separator remove water particles and other foreign material from the fuel before it reaches the injection pump.

The water separator has an internal float. When the float reaches the drain level, remind you to drain the water from the water separator.

INJECTION NOZZLE

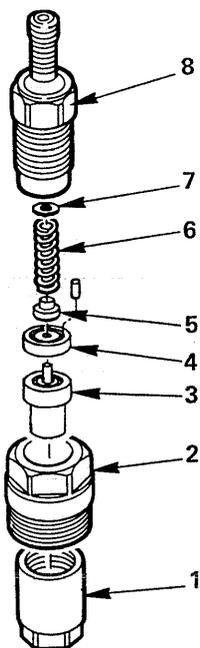

DISASSEMBLY

**Disassembly Steps**

1. Retaining nut
2. Holder nut
- ▲ 3. Injection nozzle
4. Spacer

5. Push rod
6. Spring
7. Adjusting shim
8. Nozzle holder



Important Operations

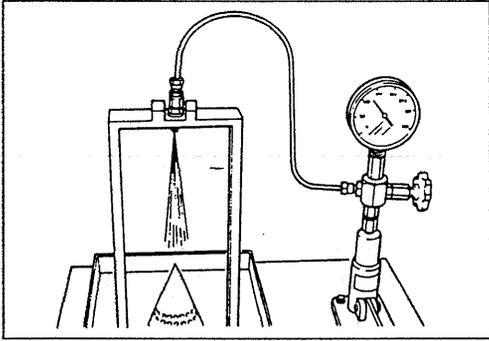

Perform this test before disassembling the injection nozzle.

- 1) Install the injection nozzle to the nozzle tester.
- 2) Use the nozzle tester to apply compressed fuel at 14.7 MPa (150 kg/cm²/2,130 psi) to the injection nozzle.



- 3) Check the area around the nozzle seat for fuel leakage.

If there is fuel leakage, the injection nozzle and the injection body must be replaced as a set.

3. Injection Nozzle

- 1) Remove the injection nozzles from the nozzle holders.
The nozzle needle valve and nozzle body combinations must be interchangeable.
- 2) Immerse the injection nozzles in a tool tray filled with clean diesel fuel to protect them from dust.

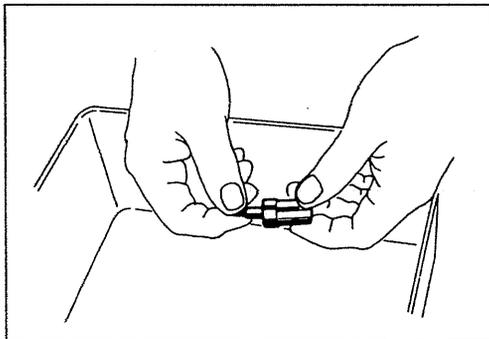



INSPECTION AND REPAIR

Make the necessary adjustments, repairs, and part replacements if excessive wear or damage is discovered during inspection.

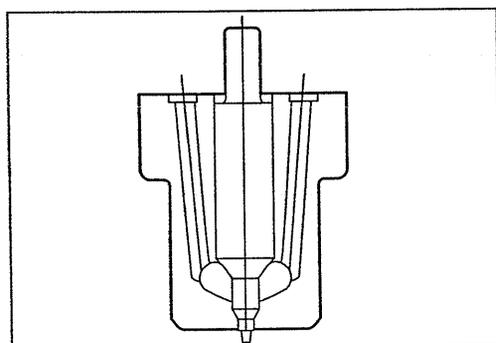
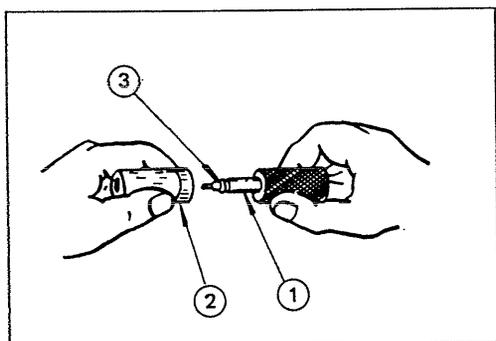
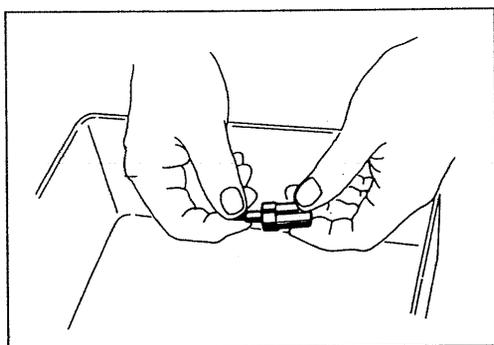

060ET003

Injection Nozzle Needle Inspection

1. Remove the nozzle needle from the nozzle body.
2. Carefully wash the nozzle needle and the nozzle body in clean diesel fuel.
3. Check that the nozzle needle moves smoothly inside the injection nozzle body.

If the nozzle needle does not move smoothly, it must be repaired (See "Nozzle Lapping Procedure" below.)

Nozzle Lapping Procedure

1. Lap the nozzle needle ① and the nozzle body ② by applying a compound of oxidized chrome and animal oil ③.

Note:

Do not apply an excessive amount of the oxidized chrome and animal oil compound to the injection needle valve seat area.



2. Carefully wash the needle valve and the nozzle body in clean diesel fuel after lapping.

Nozzle Body and Needle Valve Inspection

Check the nozzle body and the needle valve for damage and deformation.

The nozzle and body must be replaced if either of these two conditions are discovered during inspection.



REASSEMBLY

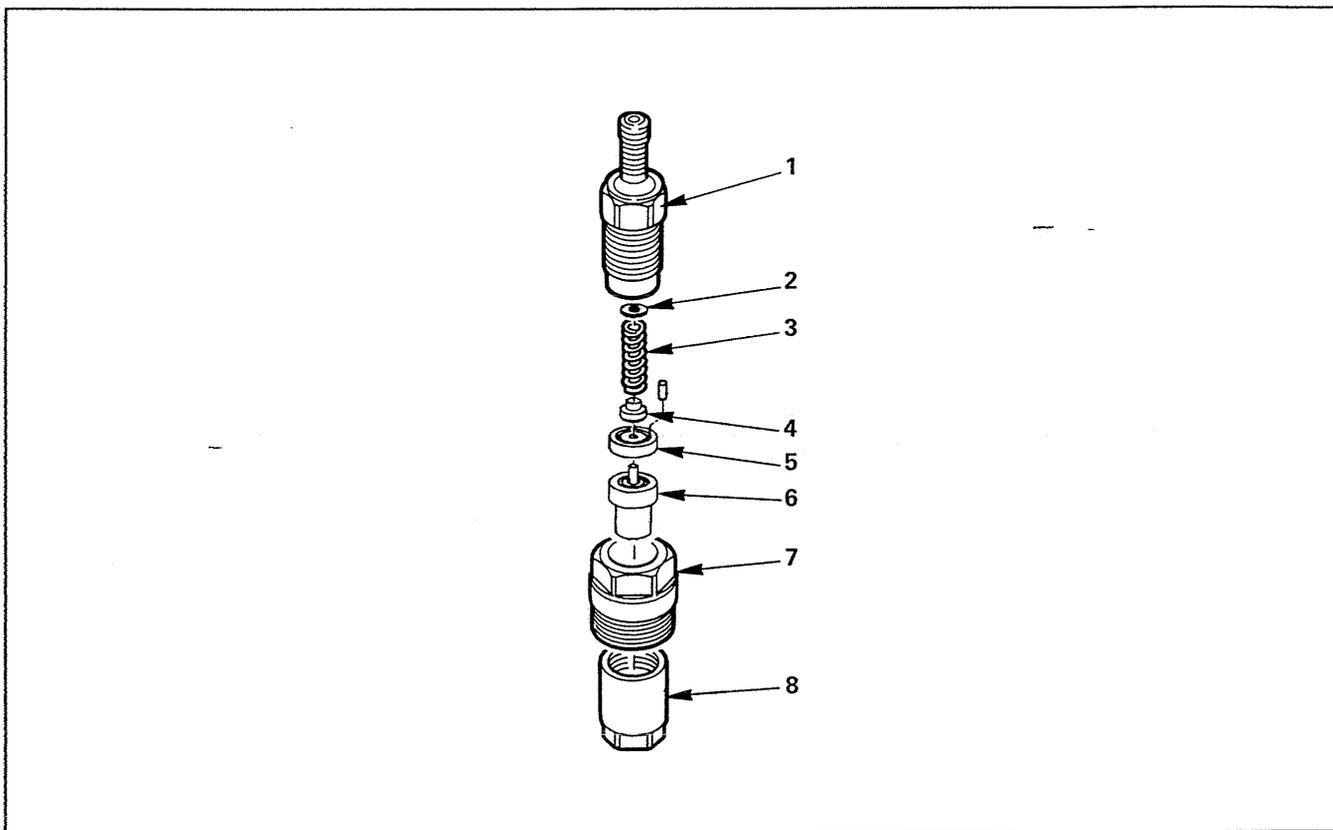

Reassembly Steps

- 1. Nozzle holder
- ▲ 2. Adjusting shim
- 3. Spring
- 4. Push rod
- 5. Spacer
- 6. Injection nozzle
- 7. Holder nut
- ▲ 8. Retaining nut



Important Operations

2. Adjust Shim

Adjust Shim Availability mm(in.)

Range	0.10 – 0.50 (0.004 – 0.020)
Increment	0.1 (0.004)

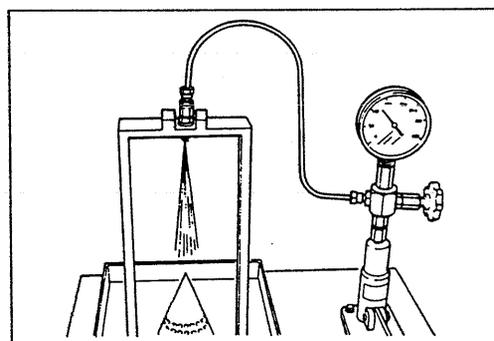
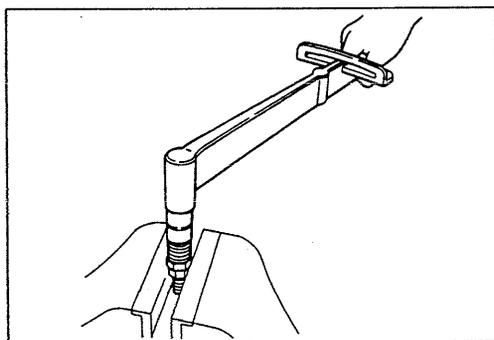

8. Retaining Nut



Tighten to the retaining nut to the specified torque.

Retaining Nut Torque kg·m(lbs.ft./N·m)

4 (35/39)

Injection Nozzle Adjustment



1. Attach the injection nozzle holder to the injection nozzle tester.
2. Apply pressure to the nozzle tester to check that the injection nozzle opens at the specified pressure.

If the injection nozzle does not open at the specified pressure, install or remove the appropriate number of adjusting shims to adjust it.

WARNING:

TEST FLUID FROM THE INJECTION NOZZLE TESTER WILL SPRAY OUT UNDER GREAT PRESSURE. IT CAN EASILY PUNCTURE A PERSON'S SKIN. KEEP YOUR HANDS AWAY FROM THE INJECTION NOZZLE TESTER AT ALL TIMES.

INJ. PUMP CALIBRATION DATA

ISUZU Part No. : 897136-6800
 Injection pump No. : 104646-1910 (NP-VE4/11F1200LNP1593)
 Pump rotation : Counterclockwise-viewed from drive side

ZEXEL No. 104746-1910
 Date : 15 FEB. 1996
 Company : ISUZU
 Maker No. : 8-97136-680-0

Refer to the service manual (VE pump B.I.S; Pub. No. EE14E-11041) for all procedures and details other than the following.

1. Test condition

- | | |
|---|--|
| 1-1 Nozzle : 105780-0060 (NP-DN0SD1510) | Injection pipe : 157805-7320 ($\phi 2 \times \phi 6-450\text{mm}$) |
| 1-2 Nozzle holder : 105780-2150 | Fuel oil temperature : $45^{+5} \text{ } ^\circ\text{C}$ |
| 1-3 Nozzle opening pressure : 13.0^{+3} MPa ($133^{+3} \text{ kgf/cm}^2$) | Supply pump pressure : 20 kPa (0.2 kgf/cm^2) |
| 1-4 Joint ass'y : 157641-4720 | Tube ass'y : 157641-4020 |
| 1-5 Test oil : ISO4113 or SAE J967d | |

2. Adjustment		Pump speed (r/min)	Settings		Charge air press. kPa (mmHg)	Difference in delivery (cm^3)
2-1	Full-load adjustment	900	58.1 ± 0.5	$\text{cm}^3/1,000 \text{ st}$		3.5
2-2	Supply pump	900	392 ± 20 (4.0 ± 0.2)	kPa (kgf/cm ²)		
2-3	Timing device travel	900	0.6 ± 0.2	mm		
2-4	Idling adjustment	350	21.8 ± 2.0	$\text{cm}^3/1,000 \text{ st}$		4.5
2-5	Start fuel adj.	100	68.0 ± 3.0	$\text{cm}^3/1,000 \text{ st}$	FULL	
2-6	Maximum speed adj.	1,320	16.5 ± 3.0	$\text{cm}^3/1,000 \text{ st}$		5.5

3. Test specification			
3-1	Timing device	N = r/min mm	900 1,325 0.6 ± 0.2 $1.2^{+0.4}_{-0.3}$
3-2	Supply pump	N = r/min kPa(kgf/cm ²)	900 392 ± 29 (4.0 ± 0.3)
3-3	Overflow delivery	N = r/min cm^3/min	900 (360 ± 130)

3-4 Fuel injection quantities

Control lever position	Pump speed (r/min)	Fuel delivery ($\text{cm}^3/1,000 \text{ st}$)	Charge air press. kPa (mmHg)
Max. speed	500	(58.1)	
	600	(60.4)	
	900	58.1 ± 1.0	
	1,000	(58.5)	
	1,200	(58.5)	
	1,320	16.5 ± 3.0	
	1,400	Below 5.0	
Idling	350	21.8 ± 2.0	
	450	Below 5.0	
Switch OFF Magnet valve	350	0	IDLE
Solenoid	Max. cut-in voltage : 8 V, Test voltage : 12 ~ 14 V		

4. Control lever angle

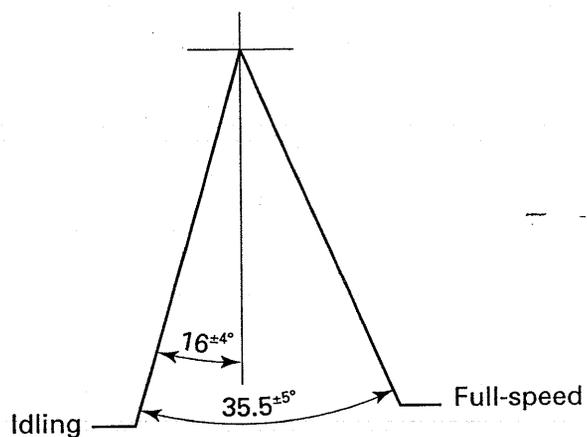

Starting injection quantity adjustment

Adjust the specified starting injection quantity (Item 2-5) using the adjusting bolt and then lock the nut.

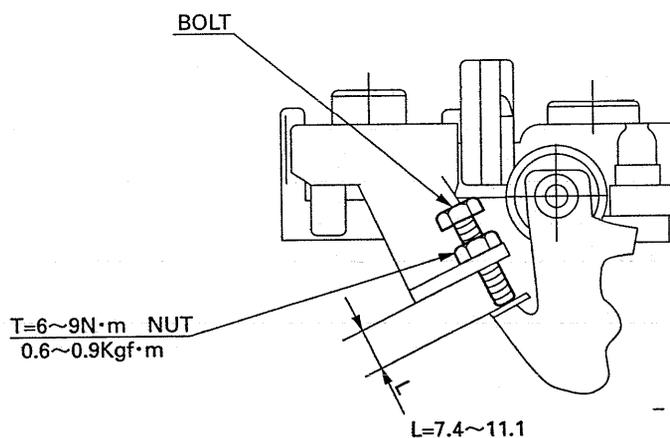

SECTION 9

ENGINE ELECTRICALS

TABLE OF CONTENTS

ITEM	PAGE
Starter	148
Alternator	161

STARTER

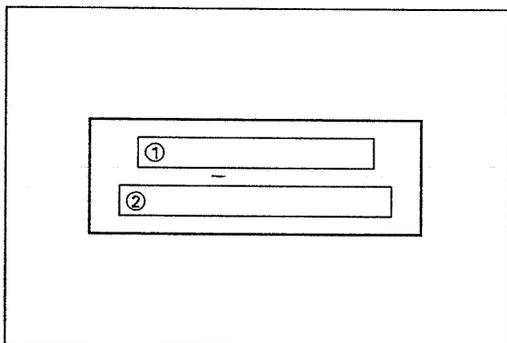

STARTER IDENTIFICATION

NIPPON DENSO starter are identified by name plate attached to the yoke. (Illustration)

- ① Isuzu part number
- ② NIPPON DENSO part number

Note:

Always check the identification number before beginning a service operation.

Applicable service data will vary according to the identification number. Use of the wrong service data will result in starter damage.

MAIN DATA AND SPECIFICATION

Isuzu Part No.		8-97042-997-0
NIPPON DENSO Part No.		228000-1890
Rated voltage	V	12
Rated output	kW	2.2
Rating		
Direction of rotation (Viewed from the pinion side)		Clockwise
Clutch type		Roller
Terminal voltage (No. Load)	V	11.5
Minimum current (No. Load)	A	120
Starter motor minimum operating speed (No. Load)	rpm	4000
Pinion gear		
Modules		2.75
Number of teeth		9
Outside diameter	mm(in.)	33.0 (4.3)
Travel distance	mm(in.)	1.51 (0.059)
Yoke outside diameter	mm(in.)	83.0 (3.27)
Number of poles		4
Brush length		
Standard	mm(in.)	16.5 (0.65)
Limit	mm(in.)	13.0 (0.51)
Brush spring standard fitting load	kg(lb./N)	(3.52/15.7-4.4/19.6)
Commutator		
Outside diameter		
Standard	mm(in.)	35.0 (1.38)
Limit	mm(in.)	34.0 (1.34)
Depth of undercut mica		
Standard	mm(in.)	0.7 - 0.9 (0.027 - 0.035)
Limit	mm(in.)	0.2 (0.008)

CIRCUIT ARRANGEMENT

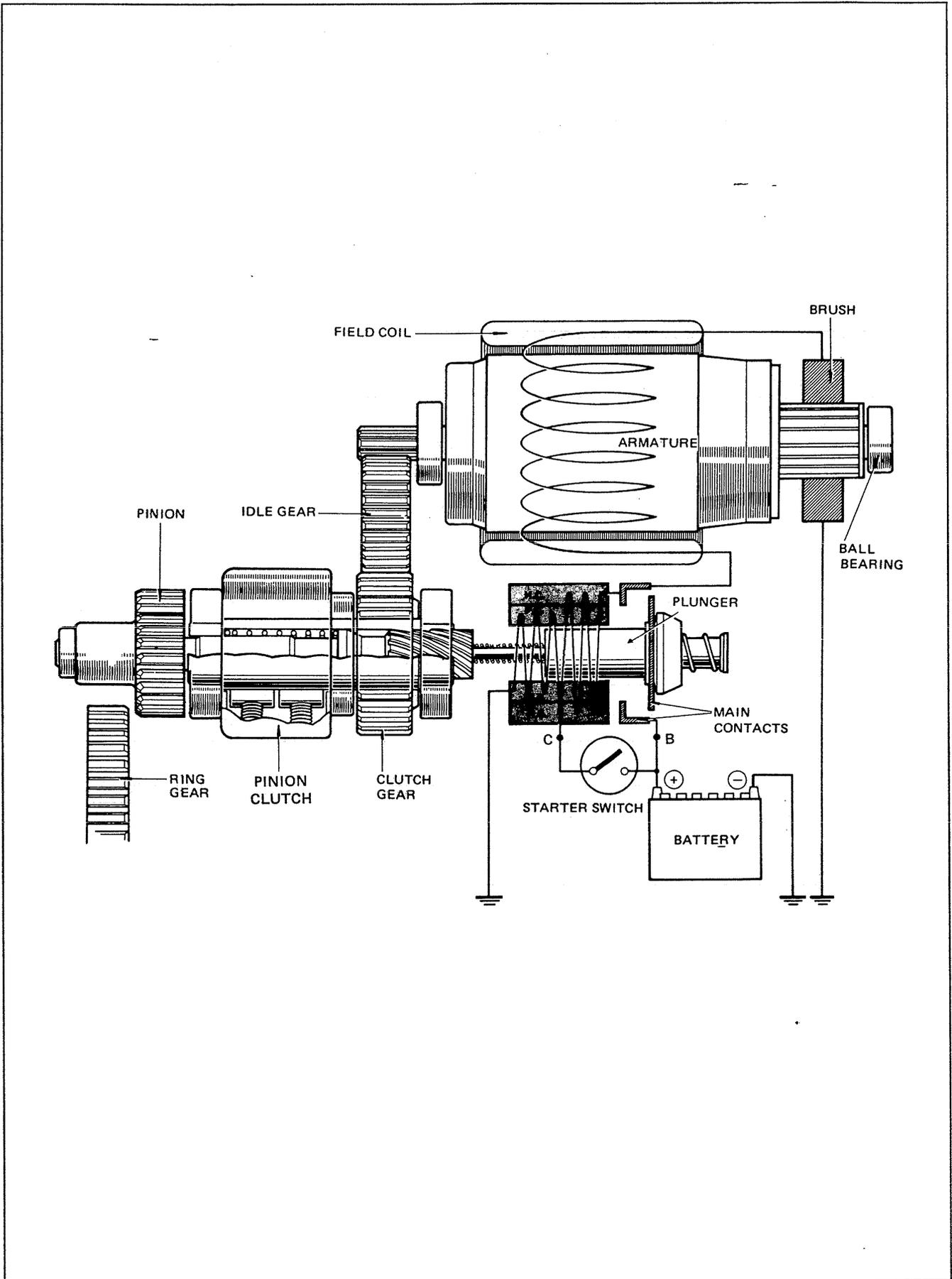

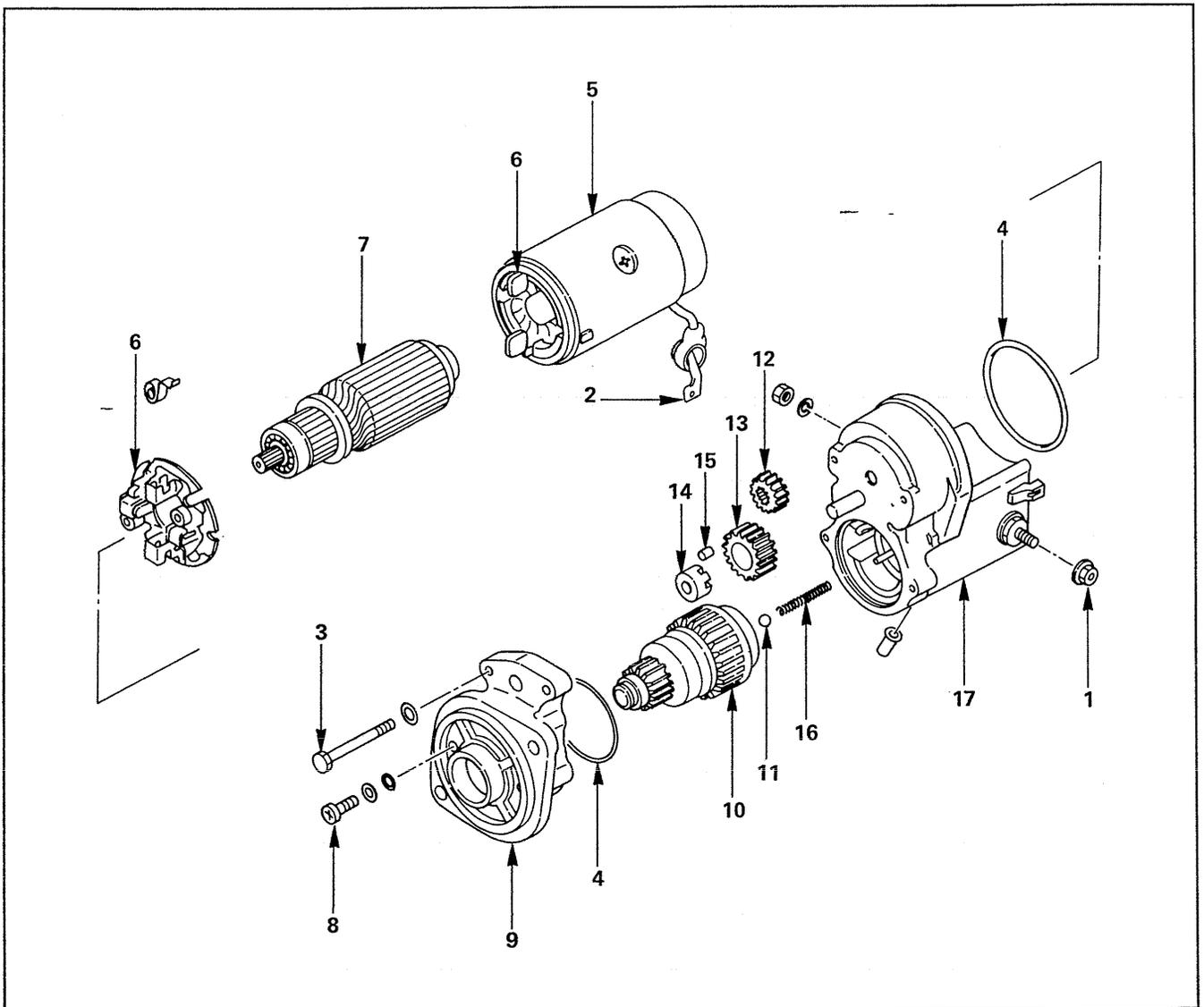

DISASSEMBLY

**Disassembly Steps**

- | | |
|-------------------------|-------------------------------|
| 1. Hexagon nut | ▲ 11. Steel ball |
| 2. Connecting lead wire | ▲ 12. Starter pinion |
| 3. Through bolt | ▲ 13. Idle gear |
| 4. Starter seal | ▲ 14. Retainer |
| ▲ 5. Yoke | ▲ 15. Clutch roller |
| ▲ 6. Brush holder | 16. Compression return spring |
| ▲ 7. Armature | ▲ 17. Magnetic switch body |
| 8. Screw | |
| ▲ 9. Starter housing | |
| ▲ 10. Pinion clutch | |



Important Operations

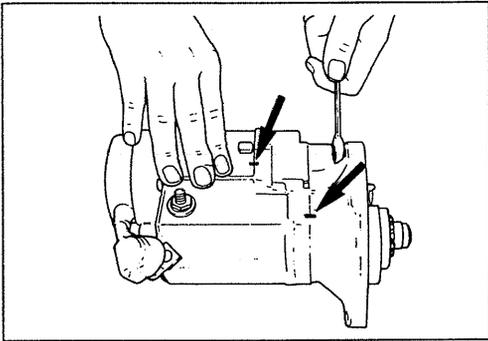

5. Yoke

9. Starter Housing

17. Magnetic Switch Body

Apply setting marks across the end frame, the yoke, and the magnetic switch body.

This will ensure reassembly of the parts in their original positions.

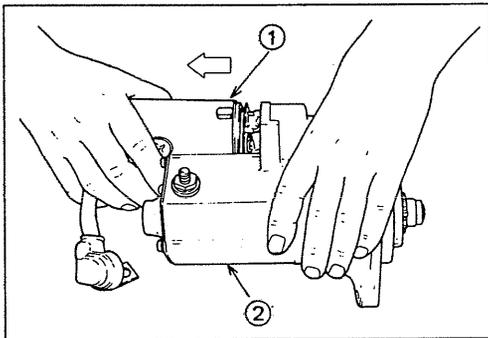

5. Yoke

Remove the yoke ① from the magnetic switch ②.

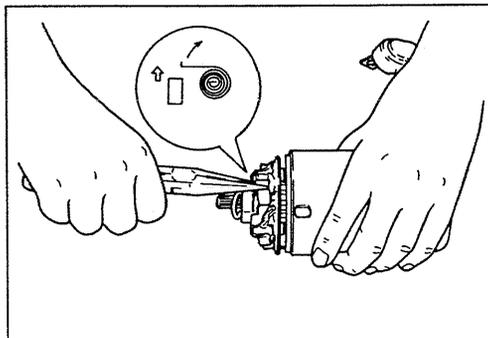

6. Brushes and Brush Holder

Use a pair of long nose pliers to remove the brushes and pull out the brush holder.

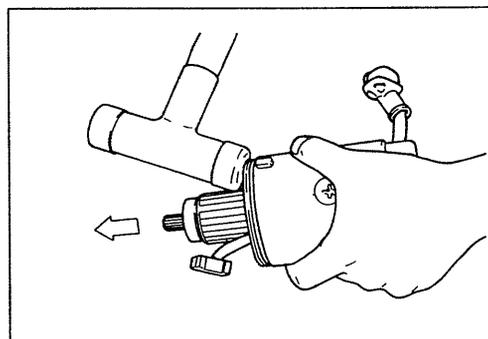

7. Armature

Remove the armature from the yoke.

Note:

If necessary, tap the yoke end with a plastic hammer to remove the armature.

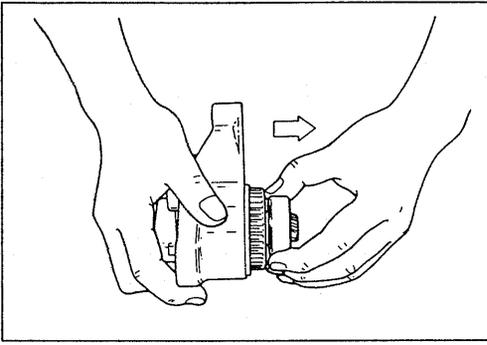
**10. Pinion Clutch**

Remove the magnetic sub-switch from the starter housing.

Note:

If the pinion is installed to the starter housing (externally attached to the magnetic sub-switch shaft, it must be removed before the magnetic sub-switch.

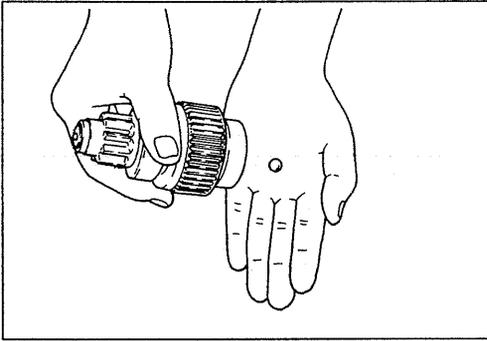
**11. Steel Ball**

Remove the steel ball from the pinion clutch.

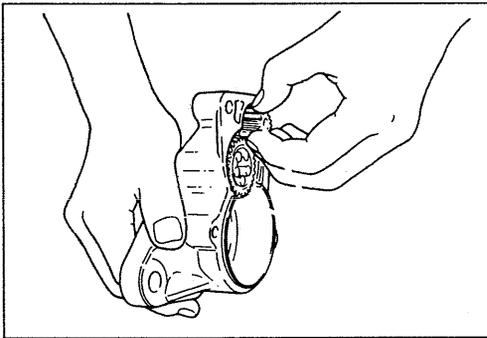
**12. Starter Pinion****13. Idler gear**

Remove the starter pinion and the idler gear from the starter housing.

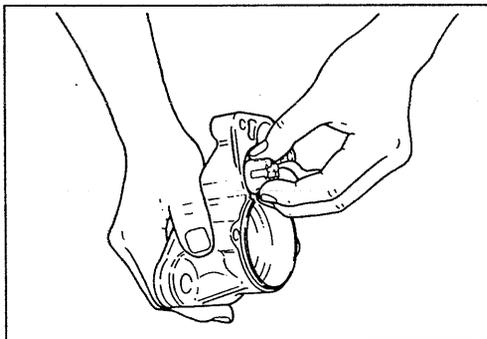
**14. Retainer****15. Clutch Roller**

Remove the retainer and clutch roller from the starter housing.



INSPECTION AND REPAIR

Make the necessary adjustments, repairs, and part replacements if excessive wear or damage is discovered during inspection.

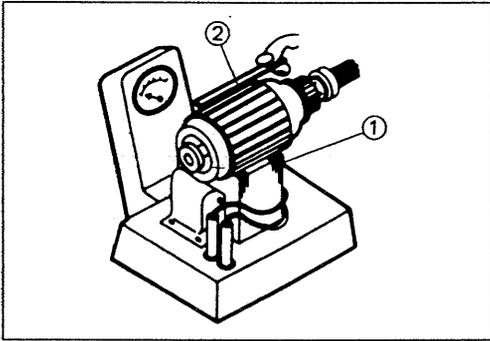

ARMATURE

Armature Short Circuit Test

1. Place the armature on a growler tester ①.
2. Hold a hack saw blade ② against the armature core while slowly rotating the armature.

If the armature is short circuited, the hack saw blade will vibrate and will be attracted to the armature core.

A short circuited armature must be replaced.

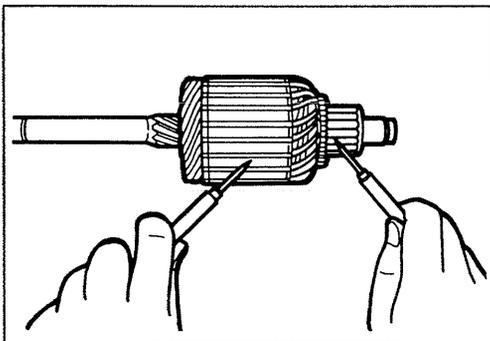

Armature Winding Ground Test



Check for continuity across the commutator segments and the core.

If there is continuity, the armature is internally grounded due to insulation failure and must be replaced.

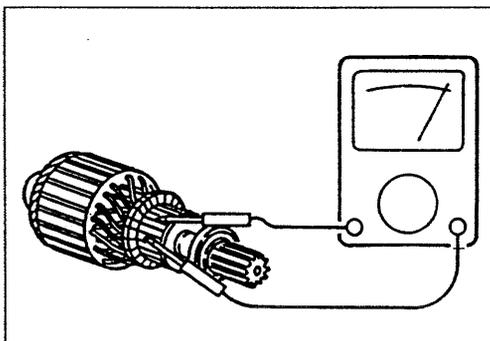

Armature Winding Continuity Test



Check for continuity across the commutator segment.

If there is no continuity, the armature coil is open and must be replaced.

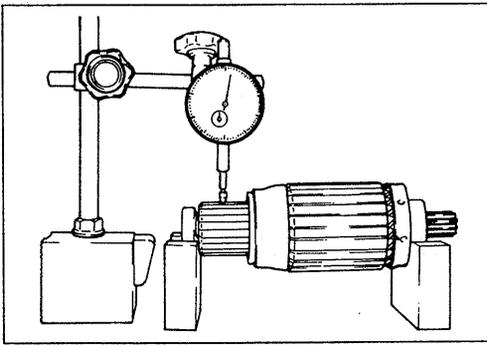

Commutator Run-Out Test



Use a dial indicator and a V-block to measure the commutator runout.

If the measured value exceeds the limit, the commutator must be replaced.

Commutator Run-Out mm(in.)

Standard	Limit
0.02 (0.0008)	0.05 (0.002)

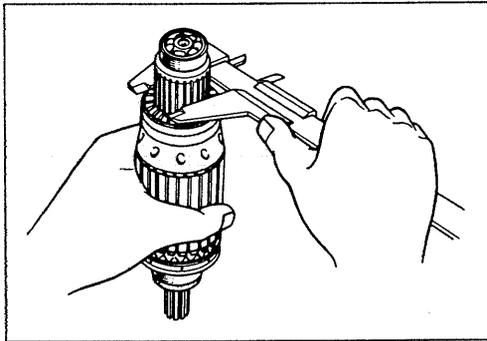

Commutator Outside Diameter Measurement



Use a vernier caliper to measure the commutator outside diameter.

If the measured value exceeds the limit, the armature must be replaced.

Commutator Outside Diameter mm(in.)

Standard	Limit
35.0 (1.38)	34.0 (1.34)

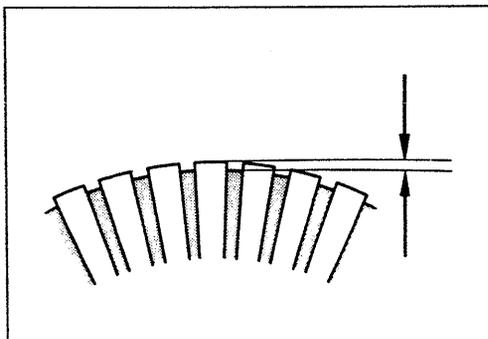

Segment Mica Depth Measurement



Use a depth gauge to measure the segment mica depth. If the measured value exceeds the limit, the segment mica must be undercut.

Segment Mica Depth mm(in.)

Standard	Limit
0.5 – 0.8 (0.02 – 0.03)	0.2 (0.008)

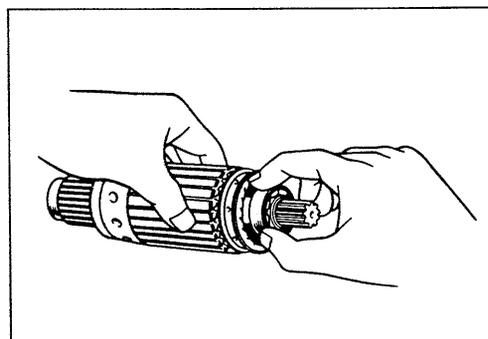

Bearing Inspection



Visually inspect the bearing.

If the bearing is worn or damaged, it must be replaced.

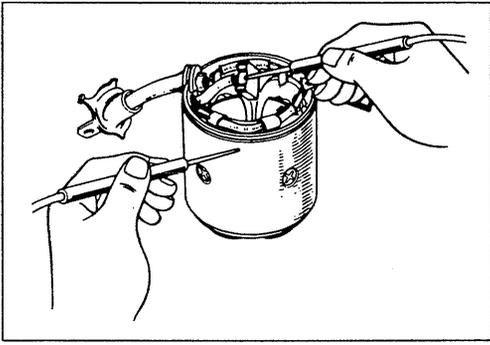

YOKE

Field Winding Ground Test

Use a circuit tester to check the field winding ground.

1. Touch one probe to the brush field winding end.
2. Touch the other probe to the bare surface of the yoke body.

There should be no continuity.

If there is continuity, the field windings are grounded.

Repair or replace the field windings.

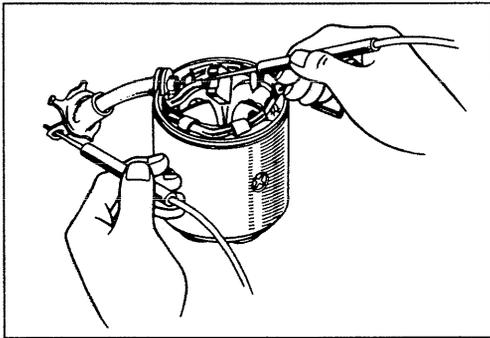

Field Winding Continuity Test

Use a circuit tester to check the field winding continuity.

1. Touch one probe to the field winding lead wire.
2. Touch the other probe to the brush.

There should be continuity.

If there is no continuity, the field windings are open.

Repair or replace the field windings.

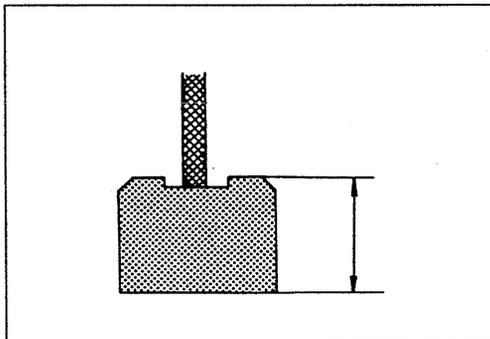

BRUSH AND BRUSH HOLDER



Brush Length Measurement

Use a vernier caliper to measure the brush length.

If the measured value exceeds the limit, the brush and/or the yoke must be replaced.

Brush Length mm(in.)

Standard	Limit
16.5 (0.65)	13.0 (0.51)

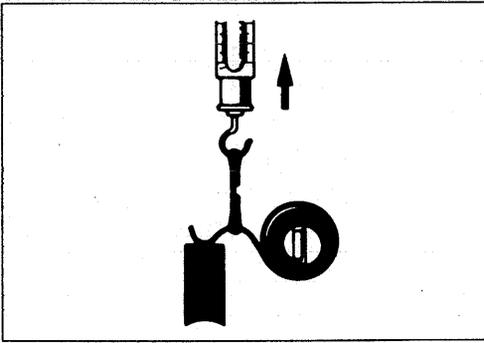

Brush Spring Inspection

Visually check the brush spring for weakness and rusting.

Replace the brush spring if it is weak or rusted.

Use a spring balancer to measure the spring tension.

If the measured value exceeds the limit, the brush spring must be replaced.

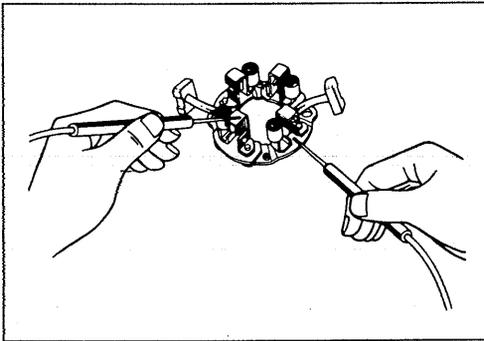

Brush Holder Insulation Test

Use a circuit tester to check the brush holder insulation.

1. Touch one probe to the field winding lead wire.
2. Touch the other probe to the brush.

There should be no continuity.

If there is continuity, the brush holder must be repaired or replaced.

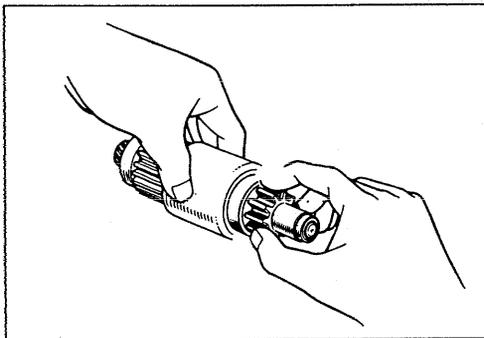

PINION CLUTCH

Pinion Inspection

Use your hand to turn the pinion in the direction of starter motor rotation. The pinion should turn freely.

Try to turn the pinion in the opposite direction. The pinion should lock.



REASSEMBLY

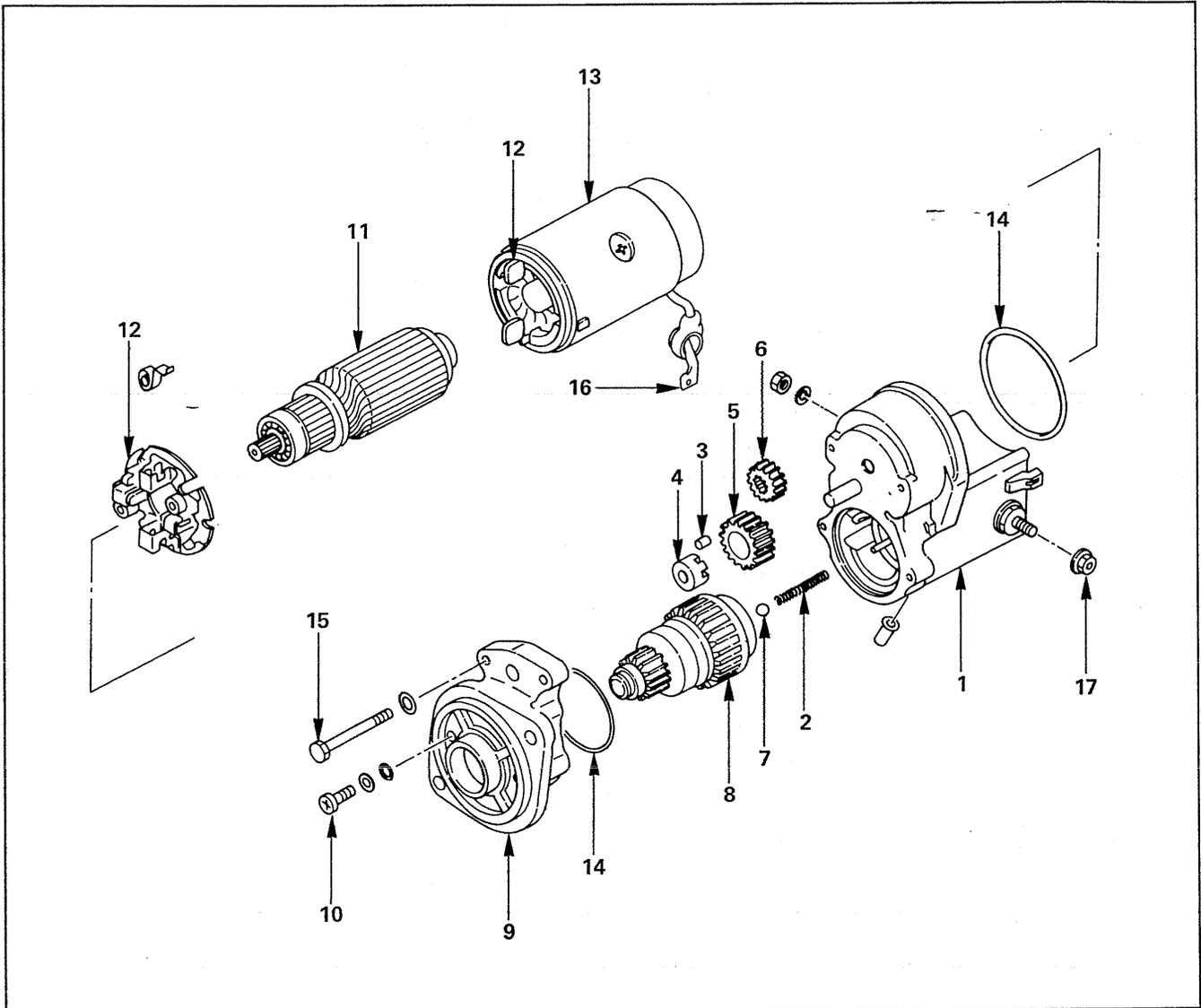

Reassembly Steps

- | | |
|--------------------------------|--------------------------|
| 1. Magnetic switch body | 11. Armature |
| ▲ 2. Compression return spring | ▲ 12. Brush holder |
| ▲ 3. Clutch roller | ▲ 13. Yoke |
| ▲ 4. Retainer | 14. Starter seal |
| 5. Idler gear | ▲ 15. Through bolt |
| 6. Starter pinion | 16. Connecting lead wire |
| 7. Steel ball | 17. Hexagon nut |
| 8. Pinion clutch | |
| 9. Starter housing | |
| 10. Screw | |



Important Operations



2. Compression Return Spring

Apply a coat of engine oil to the compression return spring.

3. Clutch Roller

4. Retainer



Apply a coat of engine oil to the clutch roller and the retainer.

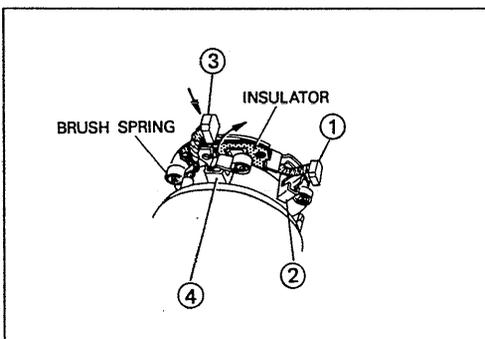

12. Brushes and Brush Holder

- 1) Install the negative brush ① on the brush holder side to the brush holder negative hole ②.
The brush holder negative hole is not insulated.
- 2) Install the positive brush ③ on the yoke side to the brush holder positive hole ④.
The brush holder positive hole is separated from the plate with the insulator.
- 3) Check that the positive brush lead wires are not grounded.
- 4) Install the brush holder to the yoke.
Take care not to damage the brush holder or the yoke.
Do not spill oil on the brush holder or the yoke.

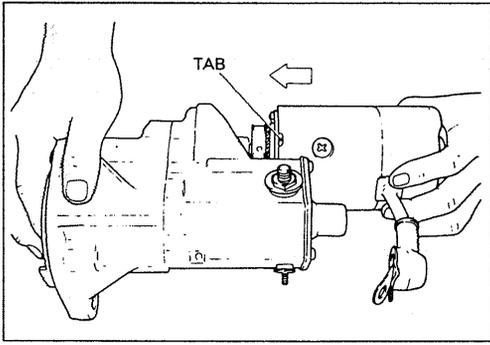

13. Yoke

- 1) Install the yoke to the magnetic switch.
The yoke must engage the notch on the magnetic switch.
- 2) Securely set the rubber boot to the magnetic switch C-terminal.

15. Throttle Bolt

Tighten the through bolt to the specified torque.



Through Bolt Torque kg·m(lb.ft./N·m)

1.1 – 1.5 (8.0 – 10.8/11 – 15)

ALTERNATOR

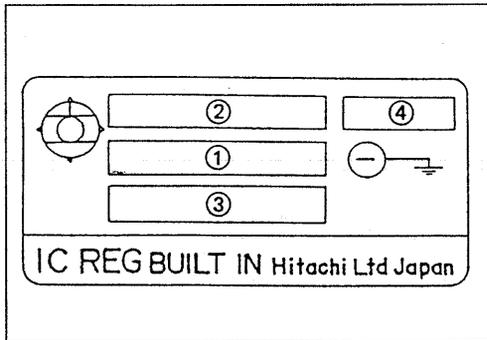

ALTERNATOR IDENTIFICATION

Hitachi generators are identified by name plate attached to the rear cover. (Illustration)

- ① Isuzu part number
- ② Manufacturer's code number
- ③ Rated output
- ④ Manufacturer's production mark

Note:

Always check the identification number before beginning a service operation.

Applicable service data will vary according to the identification number. Use of the wrong service data will result alternator damaged.

MAIN DATA AND SPECIFICATION

Engine Model to be Equipped		4JG2
Manufacturer's name		HITACHI
Isuzu Part No.		8-94423-756-0
Manufacturer's Code No.		LR135-127
Rated voltage	V	12
Rated output	A	35
Operating speed	rpm	1000-13500
Rated output at rpm	A/V/rpm	33-37/13.5/5000
No-load output at 0 amperes	V/rpm	13.5/1000 or less
Direction of rotation (viewed from the pulley side)		Clockwise
Polarity grounded		Negative
Pulley diameter (P.C.D.)	mm(in.)	80 (3.15)
Coil resistance at 20°C		
Rotor coil	Ω	3.11
Stator coil	Ω	0.13
Brush length		
Standard	mm(in.)	14.5 (0.57)
Limit	mm(in.)	7.5 (0.30)
Slip ring diameter:		
Standard	mm(in.)	31.6 (1.24)
Limit	mm(in.)	30.6 (1.20)
Shaft diameter		
Front	mm(in.)	15.0 (0.59)
Rear	mm(in.)	12.0 (0.47)
Regulator(s) applicable		Built-in
Isuzu Part No.		5-81270-004-0
Manufacturer(s) code No.		TR1Z-63

GENERAL DESCRIPTION

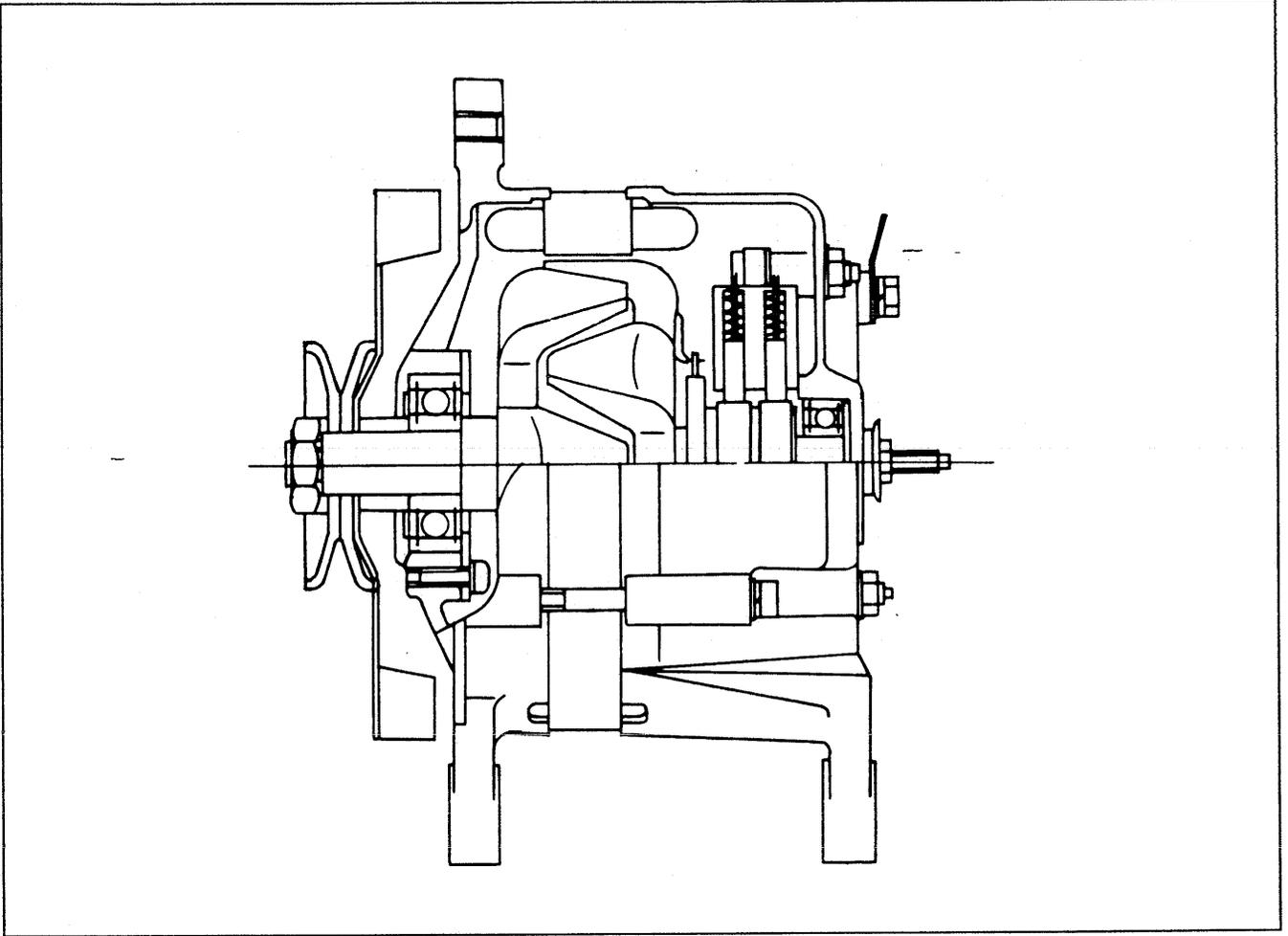

The alternator consists of the front cover, the rotor, the stator, the built-in IC regulator (some engines use a Tirrell alternator with separate regulator), and the rear cover.

This small size and light weight alternator provides excellent reliability. Its simple construction makes it very easy to service. The built-in IC regulator minimizes circuit wiring.



DISASSEMBLY

These disassembly steps are based on the built-in IC regulator type.

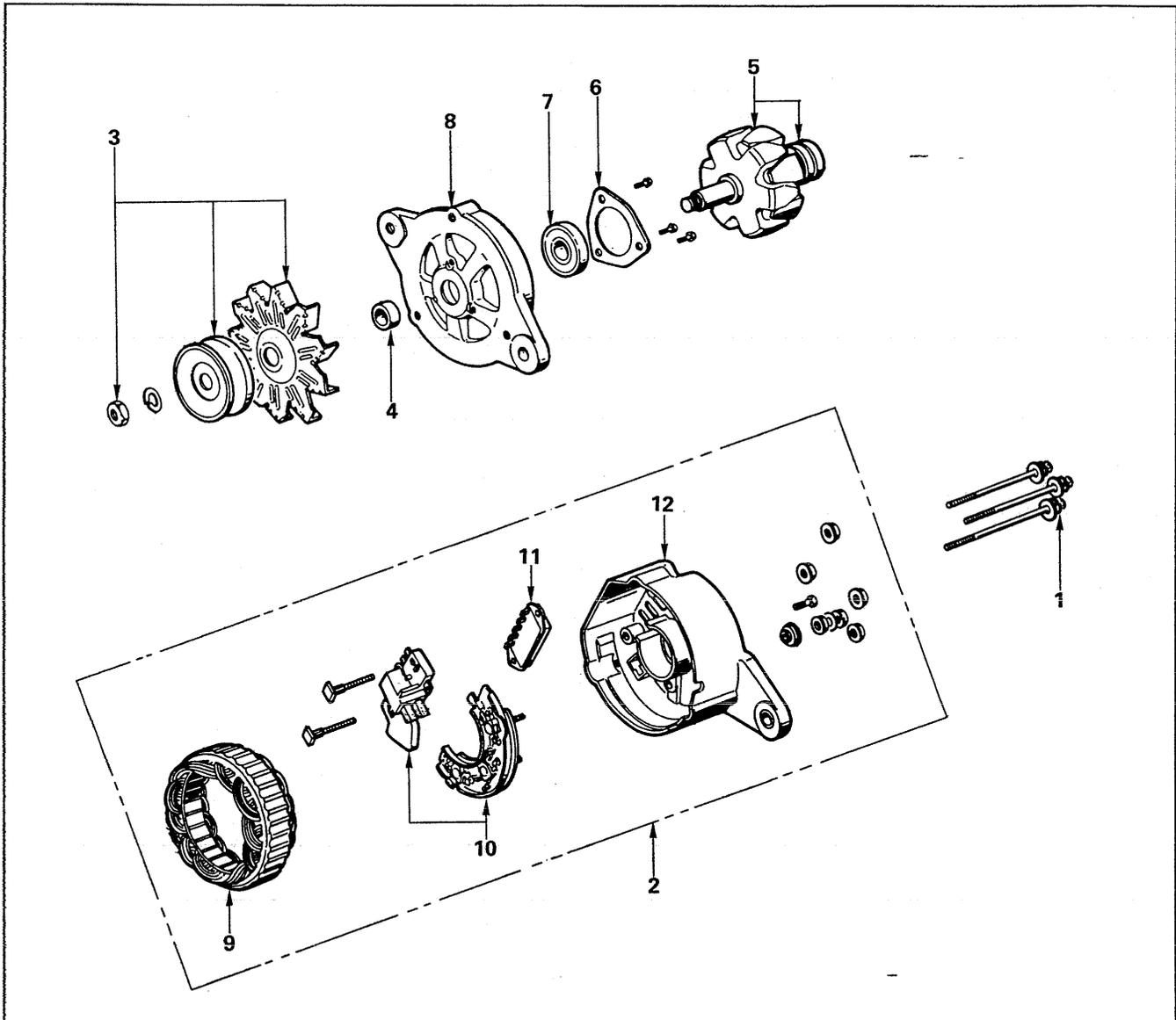

Disassembly Steps

- | | |
|--------------------------|-----------------------------------|
| 1. Through bolt | 7. Ball bearing |
| 2. Rear cover and stator | 8. Front cover |
| ▲ 3. Pulley and fan | ▲ 9. Stator |
| ▲ 4. Spacer collar | ▲ 10. Rectifier with brush holder |
| 5. Rotor with bearing | 11. IC regulator |
| 6. Bearing retainer | 12. Rear cover |



Important Operations

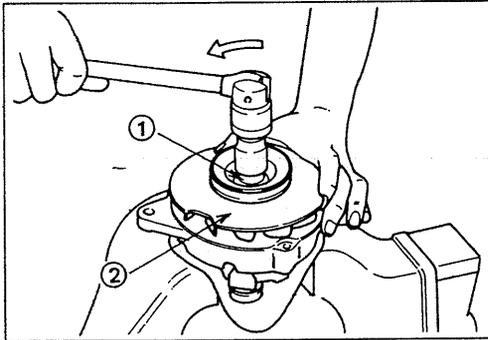

3. Pulley and Fan

- (1) Clamp the rotor shaft in a soft jaw vise.
- (2) Loosen the pulley lock nut ①.
- (3) Remove the pulley ② along with the spacer collar.

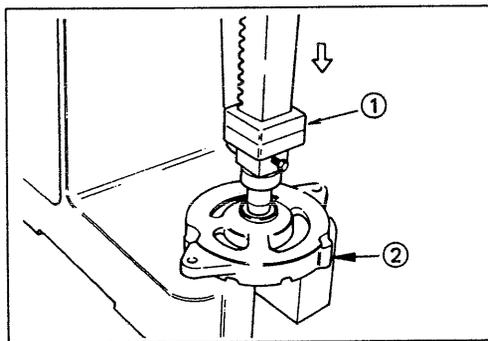

4. Rotor and Bearing

- (1) Use a plastic hammer or a press ① to remove the rotor from the front cover ②.
- (2) Remove the spacer collar.

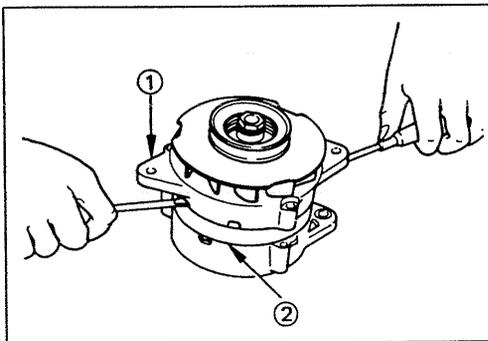

8. Front Cover

Use screwdrivers to pry the front cover ① from the stator ②.

Note:

Do not attempt to pry the coil wires from the stator.

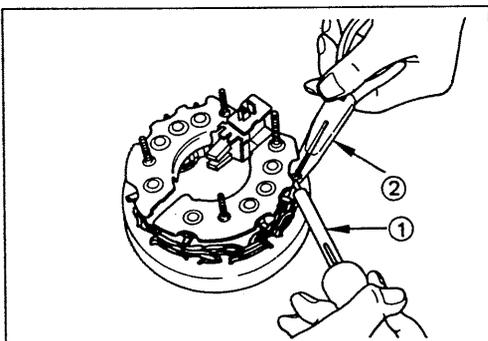

9. Stator

10. Rectifier with Brush Holder

Use a soldering iron ① and a pair of long nose pliers ② to remove the rectifiers.

Note:

Hold the rectifier leads between the rectifier and the soldering iron with the long nose pliers. This will protect the rectifier from the heat.



INSPECTION AND REPAIR

Make the necessary adjustments, repairs, and part replacements if excessive wear or damage is discovered during inspection.

ROTOR AND BEARING

Check the face of the slip rings for contamination and roughness. If found to be roughened, dress with a fine sand paper (#500 – 600). If found to be contaminated, clean with a cloth saturated with alcohol.

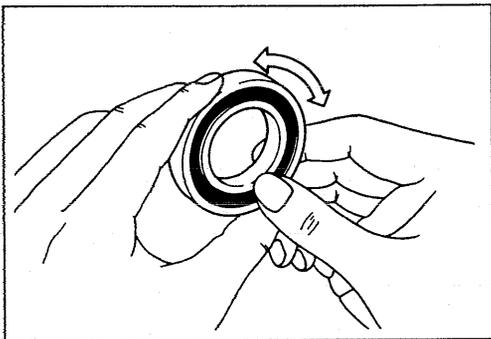

Ball Bearing

Check that the ball bearings rotate smoothly.
If the ball bearings are noisy, they must be replaced.

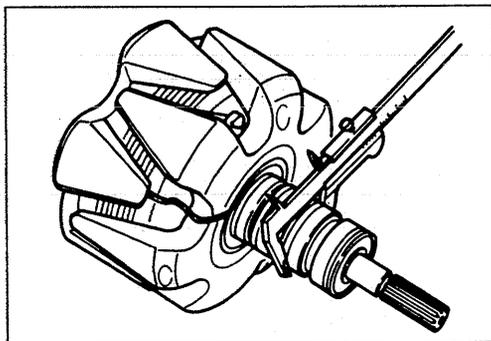

Use a vernier caliper to measure the slip ring outside diameter.

If the measured value exceeds the limit, the rotor must be replaced.

Slip Ring Outside Diameter mm(in.)

Standard	Limit
31.6 (1.24)	30.6 (1.20)

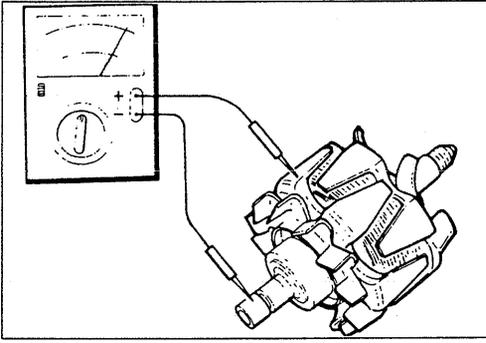

Rotor Coil Continuity Test

Use an circuit tester to test the rotor coil continuity.

1. Touch both circuit tester probes to the rotor coil slip rings.
2. Note the circuit tester reading.
The circuit tester should register approximately 9 ohms.
3. If the circuit tester does not show continuity, check the connections between the lead wire and the slip rings.

If breaks are founded, repair and repeat the rotor coil continuity test.

If there is still no rotor coil continuity, the rotor must be replaced.

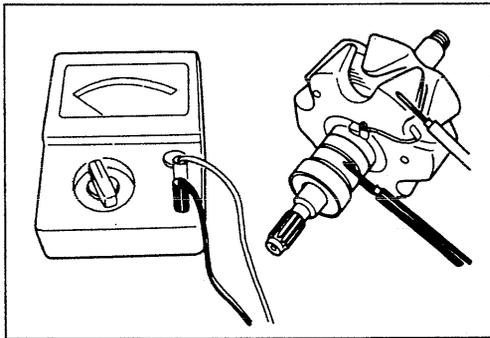

Rotor Coil Ground Test

Use an circuit tester to test the rotor coil for grounding.

1. Touch one of the circuit tester probes to the rotor shaft.
2. Touch the other circuit tester probe to one of slip rings.
3. Note the circuit tester reading.
4. Touch the circuit tester probe to the other slip ring.
5. Note the circuit tester reading.

The circuit tester should show infinity (no needle movement) at both measuring points.

If the circuit tester does not show infinity (the needle moves) at both measuring points, the rotor is grounded and must be replaced.

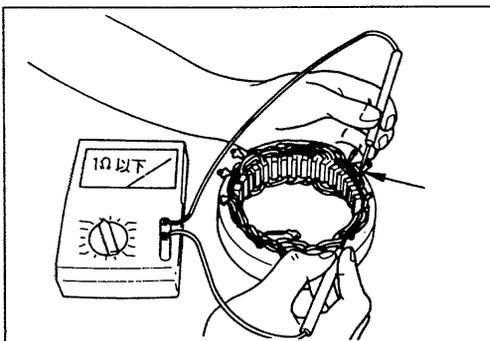

STATOR COIL

Stator Coil Continuity Test

Use an circuit tester to test the stator coil continuity.

1. Touch the circuit tester probes to two of the bare stator wires.
2. Note the circuit tester reading.
3. Move one of the circuit tester probes to a third wire.

- Note the circuit tester reading.

If the two readings (Steps 2 and 4) are identical, the stator coil has continuity.

If the two circuit tester readings are different, there is no stator continuity.

- Check the neutral junction (arrow mark) for breaks.

If breaks are found, repair and repeat the stator coil continuity test.

If there is still no stator coil continuity, the stator must be replaced.

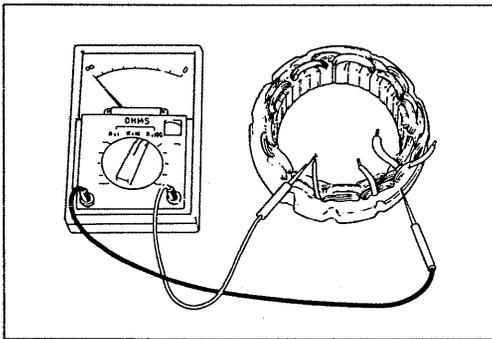

Stator Coil Ground Test



Use an circuit tester to test the stator coil for grounding.

- Touch one circuit tester probe to the bear metal surface of the stator.
- Touch the other circuit tester probe to a bare stator lead wire.
- Note the circuit tester reading.

The circuit tester should show infinity (no needle movement).

If the circuit tester shows a value other than infinity (the needle moves), the stator is grounded and must be replaced.

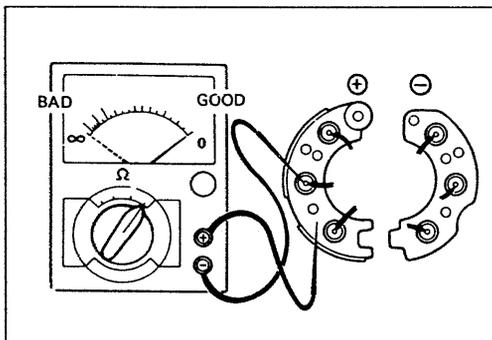

RECTIFIER

Rectifier (Positive Diode) Continuity Test



Use an circuit tester to test rectifier continuity.

- Touch the circuit tester positive probe to the rectifier holder.
- Touch the circuit tester negative probe to each of the diode terminals in turns.

3. Note the meter reading for each diode terminal.
All of the diode should show continuity.
If a diode shows no continuity, it is open circuit. The rectifier assembly must be replaced.

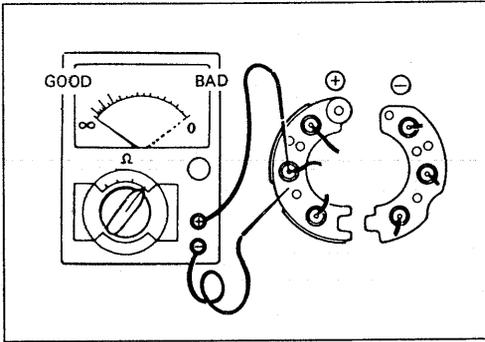

4. Touch the circuit tester negative probe to the rectifier holder.
5. Touch the circuit tester positive probe to each of the diode terminals in turn.
6. Note the meter reading for each diode terminal.
None of the diodes should show continuity.
If a diode shows continuity, it is shorted. The rectifier assembly must be replaced.

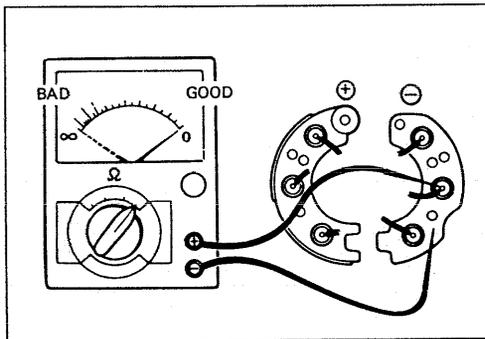

Rectifier (Negative Diode) Continuity Test



Use a circuit tester to test the rectifier continuity.

1. Touch the circuit tester negative probe to the rectifier holder.
2. Touch the circuit tester positive probe to each of the diode terminals in turn.
3. Note the meter reading for each diode terminal.
All of the diode should show continuity.
If a diode shows no continuity, it is open. The rectifier assembly must be replaced.
4. Touch the circuit tester positive probe to the rectifier holder.
5. Touch the circuit tester negative probe to each of the diode terminals in turn.
6. Note the meter reading for each diode terminal.
None of the diode should show continuity.
If a diode shows continuity, it is shorted. The rectifier assembly must be replaced.

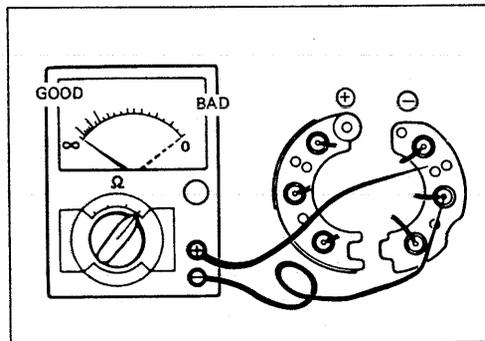

Rectifier Assembly Replacement Procedure



Use the Rectifier Service Kit to replace the rectifier assembly in the following steps.

1. Connect the three inside lead wires to the "N" terminals ①.
2. Connect the three outside lead wires ② to the outside terminals.
3. Wind the stator lead wires around the rectifier lead wires (included in the Rectifier Service Kit) and solder them.

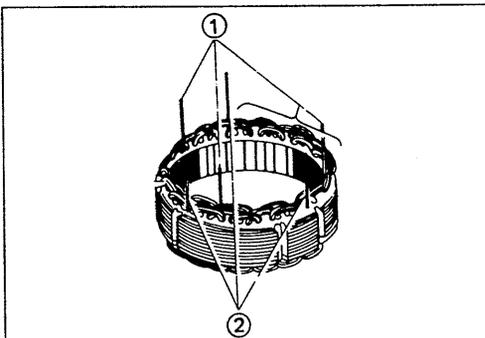

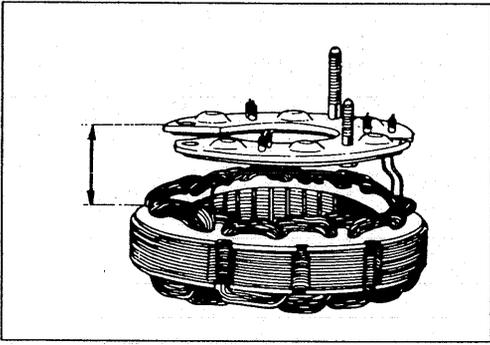

Note:



1. The stator lead wires must be cut to the proper length before they are connected to the rectifier lead wires. If the stator lead wires are too long or too short, trouble may occur.

Stator Lead Wire Length mm(in.)

33.5 (1.32)

2. Take care not to damage the rectifier paint surfaces.

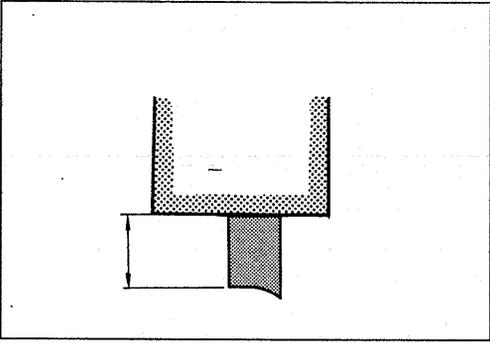

BRUSH

Use a vernier caliper to measure the brush.

If the measured value exceeds the limit, the brush must be replaced.

Brush Length mm(in.)

	Standard	Limit
8-94423-756-0	14.5 (0.57)	7.5 (0.30)

Brushes are provided with a line which indicates the limit of usage.



REASSEMBLY

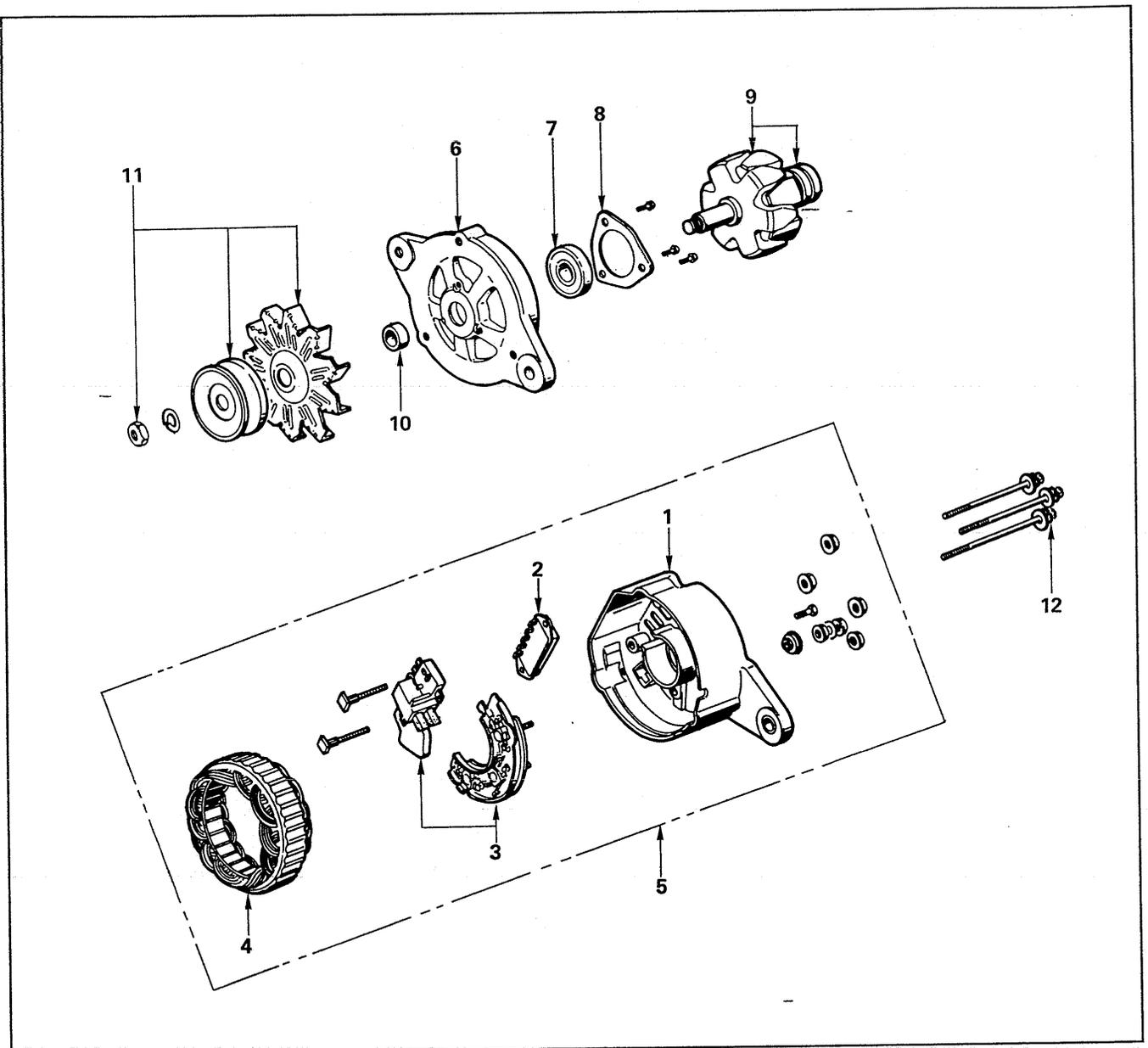

Reassembly Steps

- | | |
|----------------------------------|-----------------------|
| 1. Rear cover | ▲ 7. Ball bearing |
| 2. IC regulator | 8. Bearing retainer |
| ▲ 3. Rectifier with brush holder | 9. Rotor with bearing |
| ▲ 4. Stator | 10. Spacer collar |
| 5. Rear cover and stator | ▲ 11. Pulley and fan |
| 6. Front cover | 12. Through bolt |



Important Operations

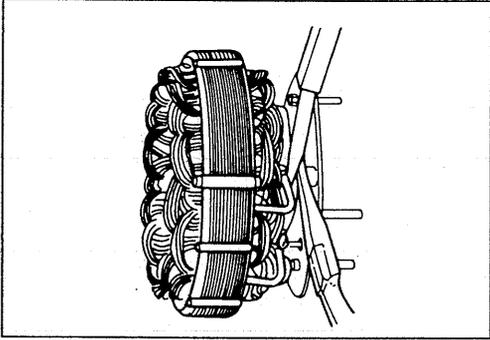

3. Rectifier with Brush Holder

4. Stator

When connecting stator coil leads and diode leads using solder, use long-nose pliers and finish the work as quickly as possible to prevent the heat from being transferred to the diodes.

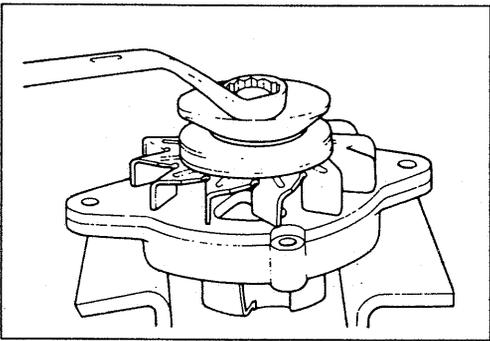

11. Pulley and Fan

Tighten the pulley and fan to the specified torque.



Pulley and Fan Nut Torque kg·m(lb.ft./N·m)

5.0 – 6.5 (36 – 47/49 – 64)

SECTION 10
TROUBLESHOOTING
TABLE OF CONTENTS

ITEM	PAGE
Hard starting	175
Unstable idling	179
Insufficient power	182
Excessive fuel consumption	186
Excessive oil consumption	188
Overheating	189
White exhaust smoke	191
Dark exhaust smoke	192
Oil pressure does not rise	193
Abnormal engine noise	195

TROUBLESHOOTING

Refer to this Section to quickly diagnose and repair engine problems.

Each troubleshooting chart has three headings arranged from left to right.

(1) Checkpoint (2) Trouble Cause (3) Countermeasure

This Section is divided into ten sub-sections:

1. Hard Starting
 - 1) Starter inoperative
 - 2) Starter operates but engine does not turn over
 - 3) Engine turns over but does not start
2. Unstable Idling
3. Insufficient Power
4. Excessive Fuel Consumption
5. Excessive Oil Consumption
6. Overheating
7. White Exhaust Smoke
8. Dark Exhaust Smoke
9. Oil Pressure Does Not Rise
10. Abnormal Engine Noise

1. HARD STARTING

1. STARTER INOPERATIVE

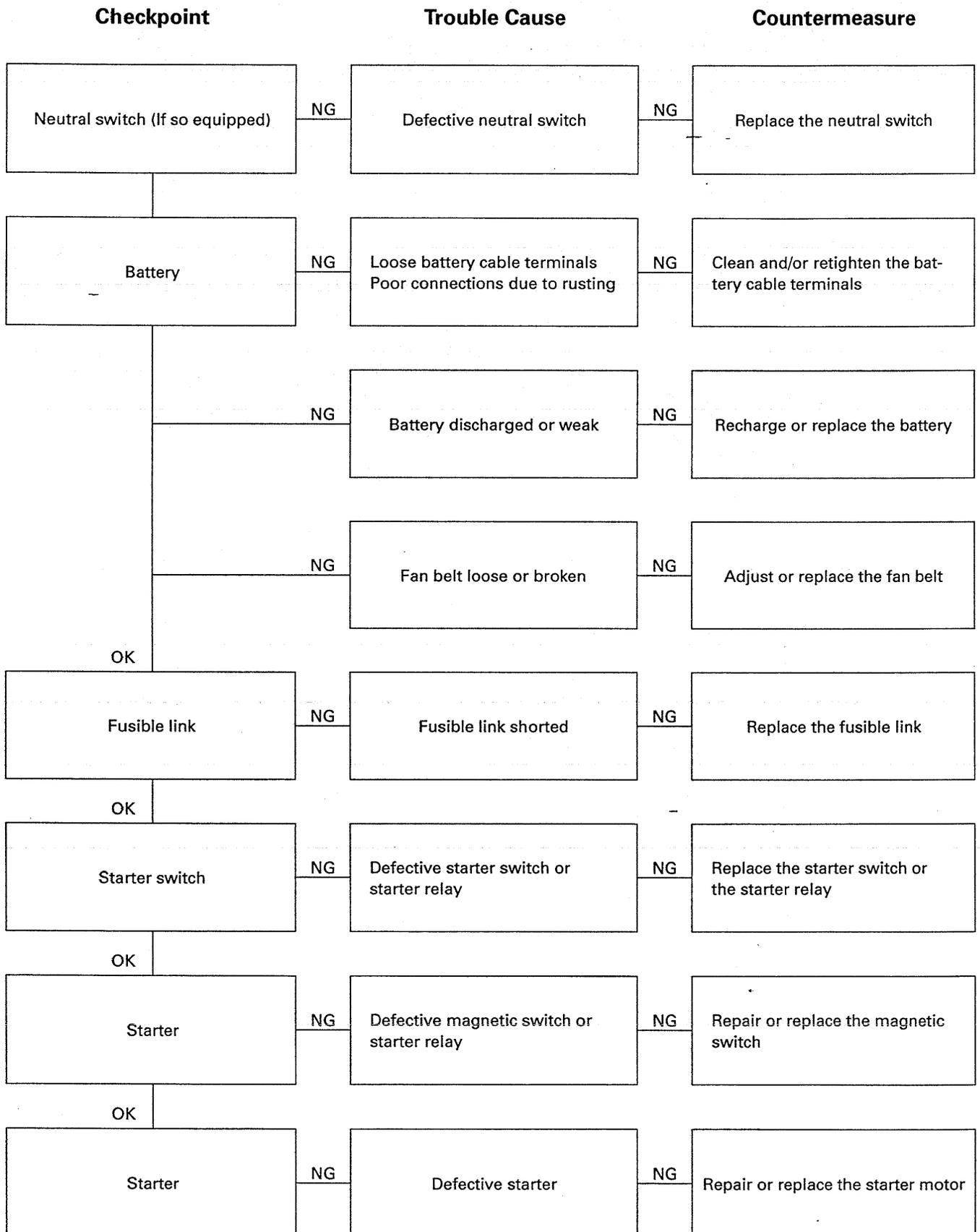

1. HARD STARTING

2. STARTER OPERATES BUT ENGINE DOES NOT TURN OVER

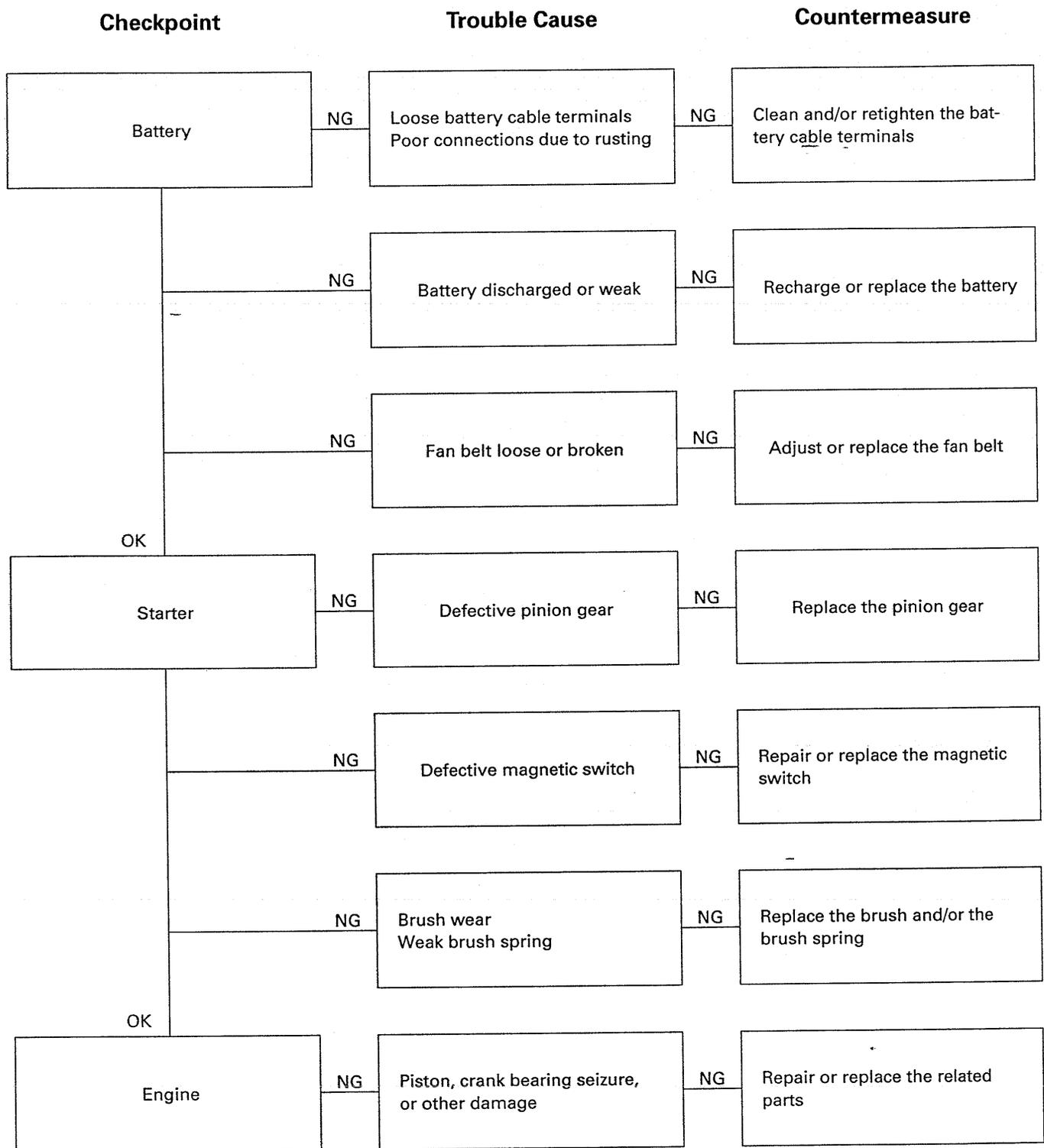

1. HARD STARTING

3. ENGINE TURNS OVER BUT DOES NOT START

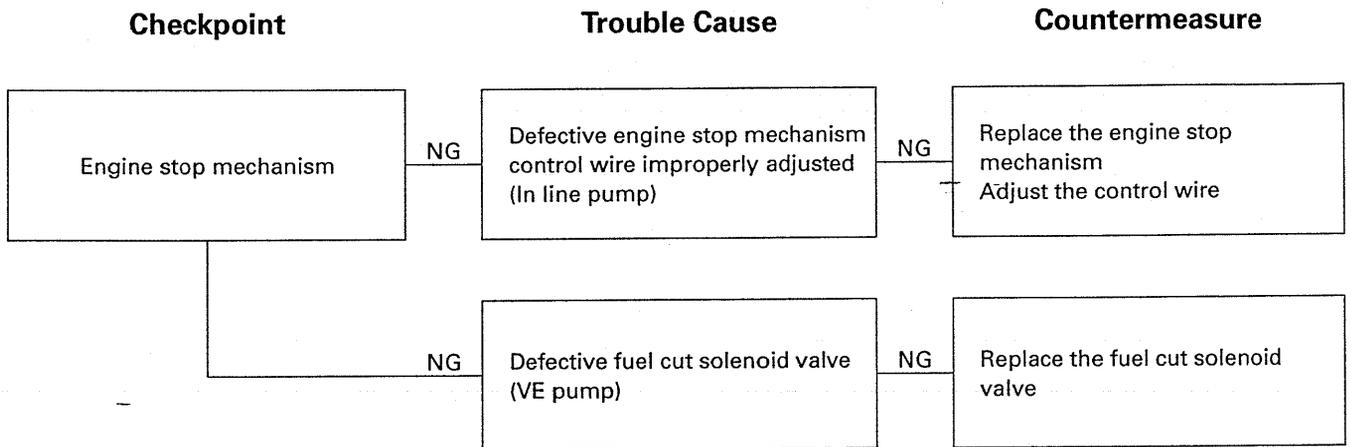

FUEL IS NOT BEING DELIVERED TO THE INJECTION PUMP

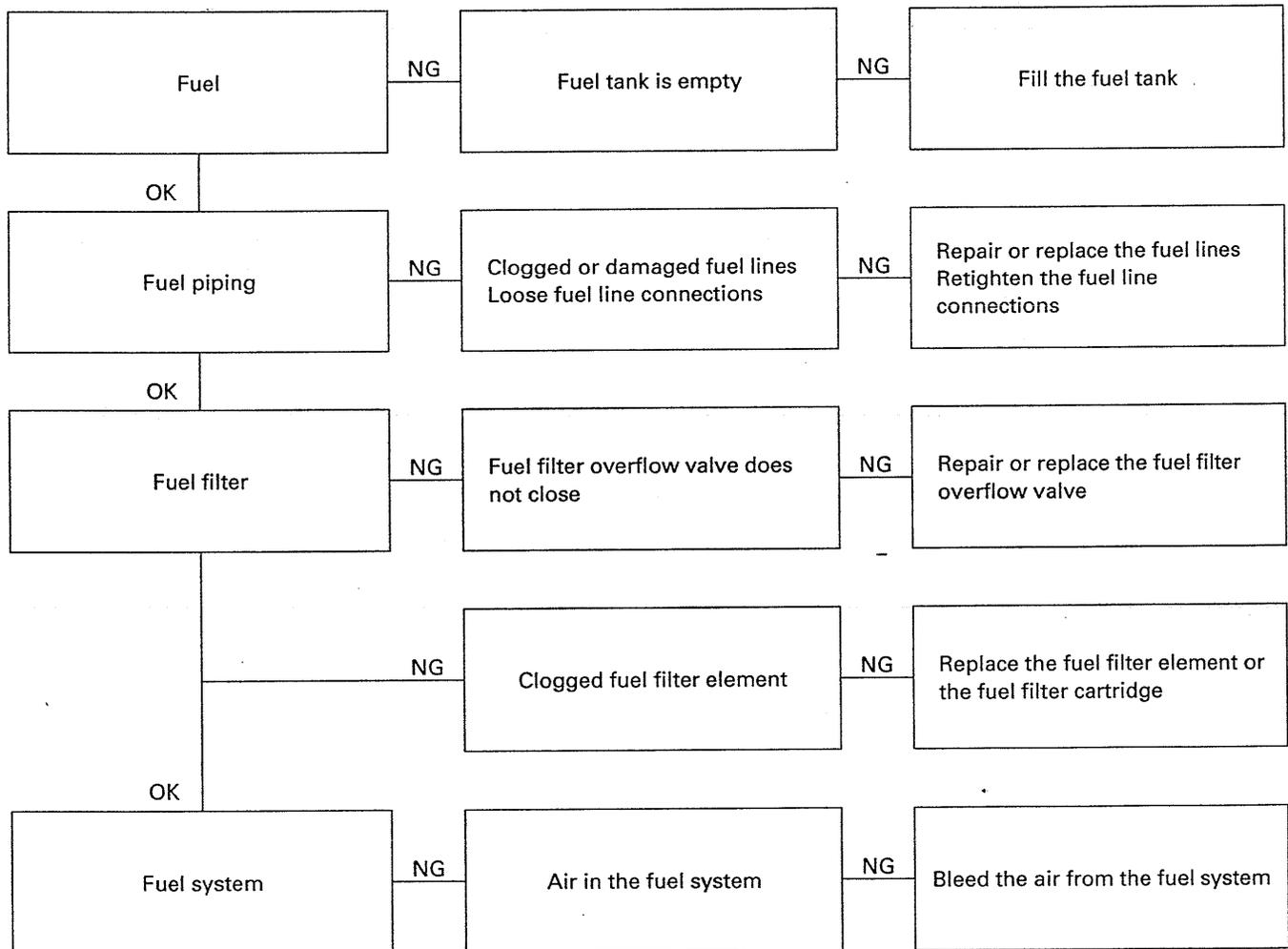

Continued on the next page

1. HARD STARTING

3. ENGINE TURNS OVER BUT DOES NOT START

FUEL IS BEING DELIVERED TO THE INJECTION PUMP

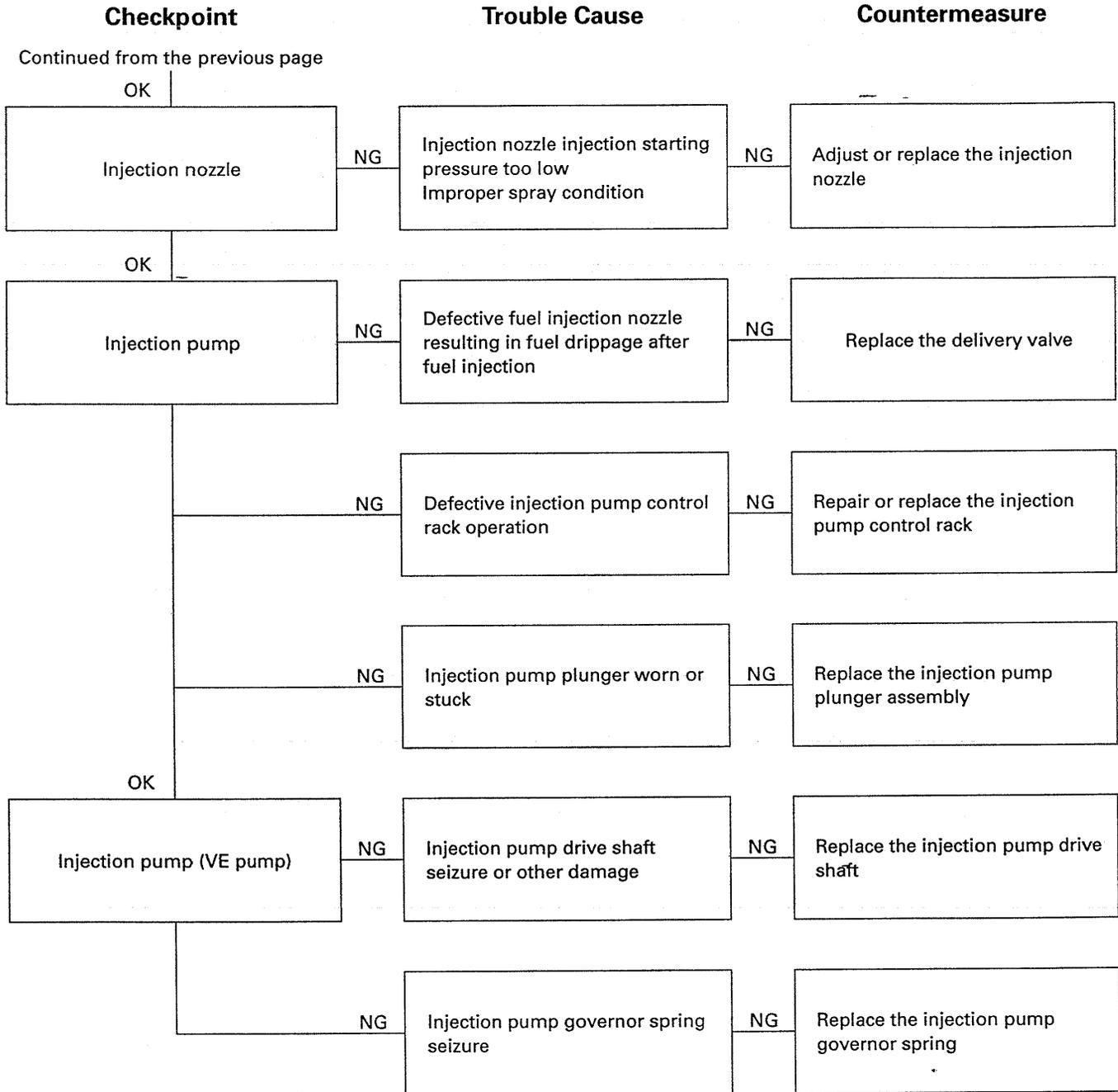

2. UNSTABLE IDLING

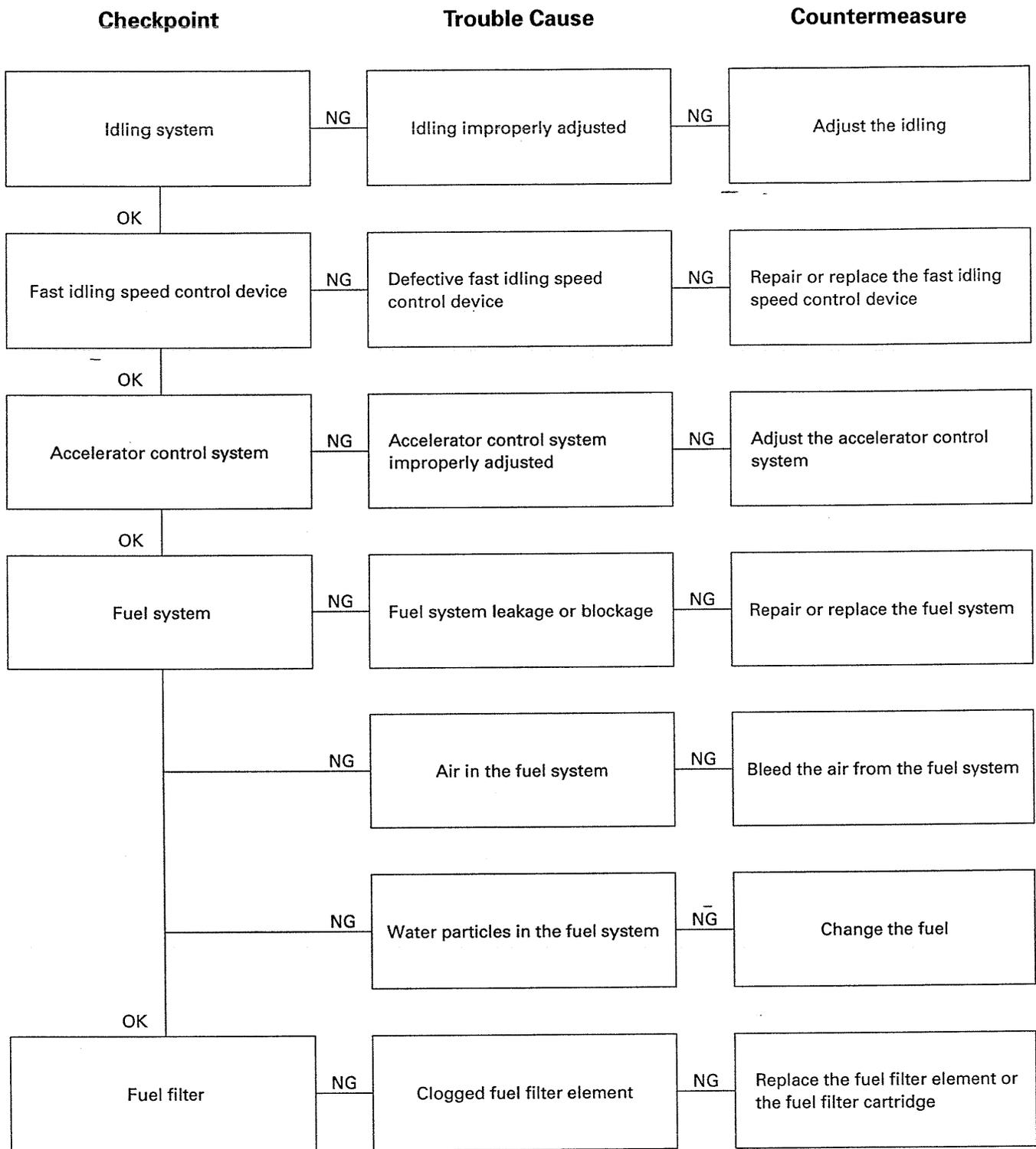

Continued on the next page

2. UNSTABLE IDLING

Checkpoint	Trouble Cause	Countermeasure
Continued from the previous page		
OK		
Injection pump	Defective governor lever operation	Repair or replace the governor lever
	Regulator valve improperly adjusted (VE pump only)	Adjust or replace the regulator valve
	Broken plunger spring	Replace the plunger spring
	Worn plunger	Replace the plunger assembly
	Worn camshaft (In-line pump only)	Replace the camshaft
	Worn roller tappet (In-line pump only)	Replace the roller tappet
	Worn cam disc (VE pump only)	Replace the cam disc

Continued on the next page

2. UNSTABLE IDLING

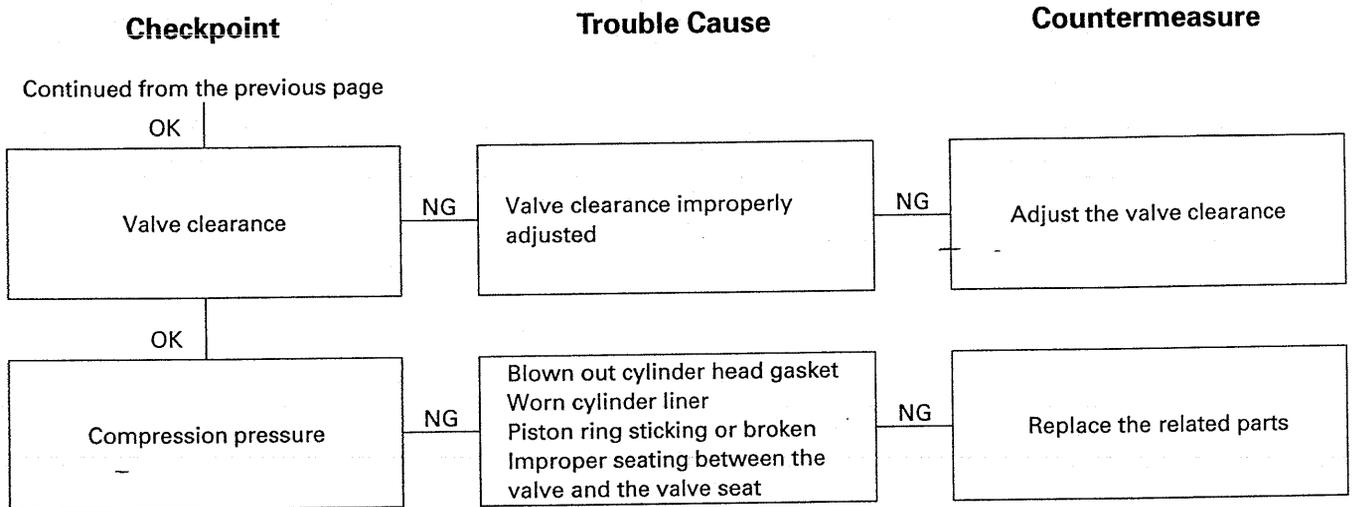

3. INSUFFICIENT POWER

Checkpoint		Trouble Cause		Countermeasure
Air cleaner	NG	Clogged air cleaner element	NG	Clean or replace the air cleaner element
OK				
Fuel	NG	Water particles in the fuel	NG	Replace the fuel
OK				
Fuel filter	NG	Clogged fuel filter element	NG	Replace the fuel filter element or the fuel filter cartridge
OK				
Fuel feed pump	NG	Defective fuel feed pump	NG	Repair or replace the fuel feed pump
OK				
Injection nozzle	NG	Injection nozzle sticking	NG	Replace the injection nozzle
	NG	Injection nozzle injection starting pressure too low Improper spray condition	NG	Adjust or replace the injection nozzle
OK				
Fuel injection pipes	NG	Fuel injection pipes damaged or obstructed	NG	Replace the fuel injection pipes

Continued on the next page

3. INSUFFICIENT POWER

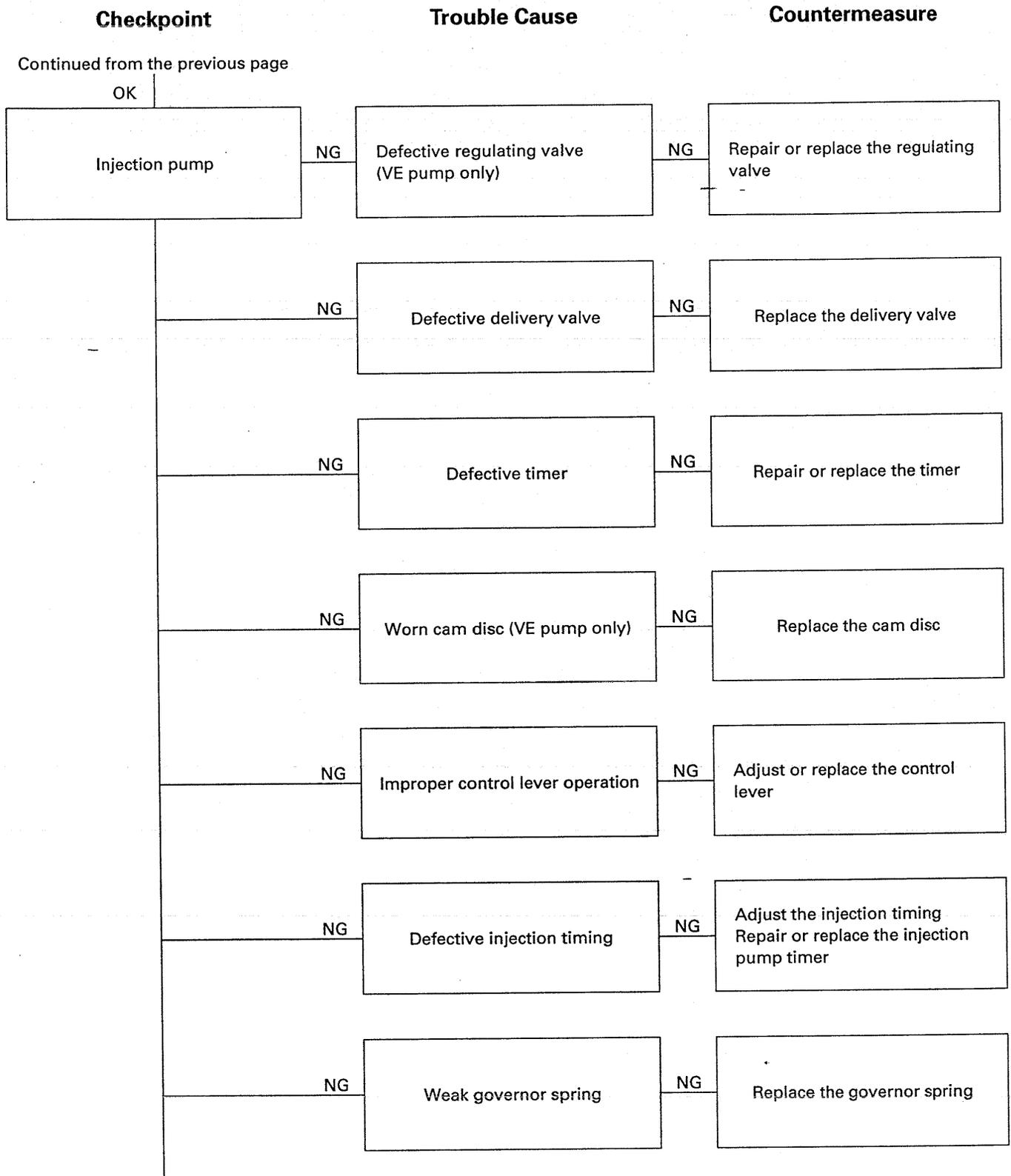

Continued on the next page

3. INSUFFICIENT POWER

Checkpoint	Trouble Cause	Countermeasure
Continued from the previous page		
OK		
Injection pump	Worn plunger	Replace the plunger assembly
	Worn camshaft (In-line pump only)	Replace the camshaft
	Worn roller tappet (In-line pump only)	Replace the roller tappet
	Worn cam disc (VE pump only)	Replace the cam disc
OK		
Compression pressure	Blown out cylinder head gasket Worn cylinder liner Piston ring sticking or broken Improper seating between the valve and the valve seat	Replace the related parts
OK		
Valve clearance	Valve clearance improperly adjusted	Adjust the valve clearance
OK		
Valve spring	Valve spring weak or broken	Replace the valve spring

Continued on the next page

3. INSUFFICIENT POWER

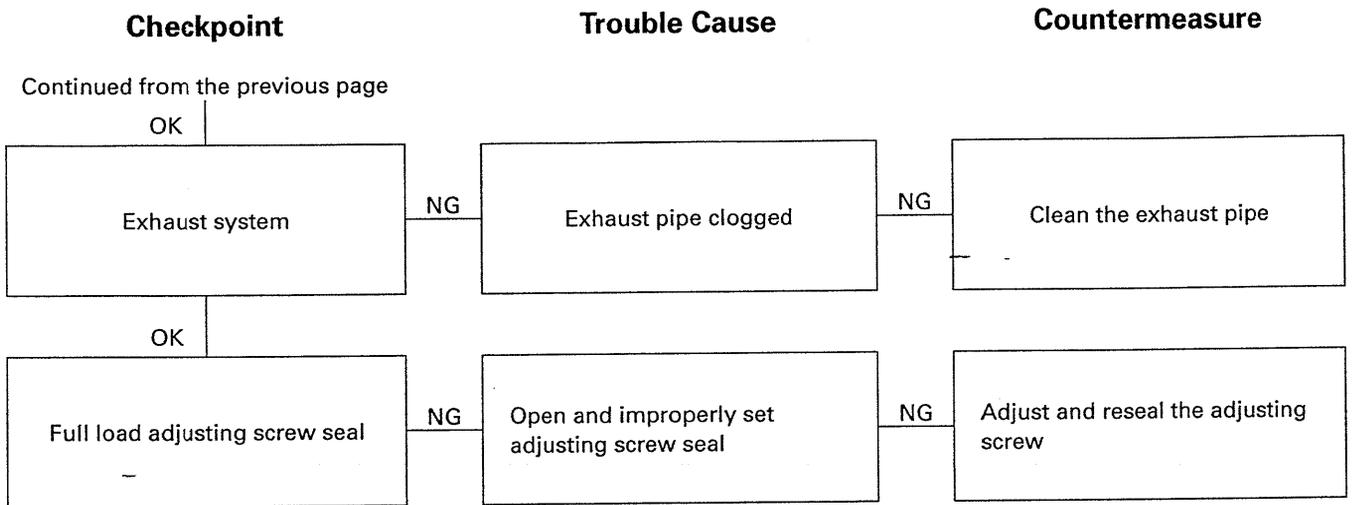

4. EXCESSIVE FUEL CONSUMPTION

Checkpoint		Trouble Cause		Countermeasure
Fuel system	NG	Fuel leakage	NG	Repair or replace the fuel system related parts
OK				
Air cleaner	NG	Clogged air cleaner element	NG	Clean or replace the air cleaner element
OK				
Idling speed	NG	Poorly adjusted idling speed	NG	Adjust the idling speed
OK				
Injection nozzle	NG	Injection nozzle injection starting pressure too low Improper spray condition	NG	Adjust or replace the injection nozzle
OK				
Fuel injection timing	NG	Fuel injection timing improperly adjusted	NG	Adjust the fuel injection timing
OK				
Injection pump	NG	Defective delivery valve resulting is fuel drippage after fuel injection	NG	Replace the delivery valve
OK				
Valve clearance	NG	Valve clearance improperly adjusted	NG	Adjust the valve clearance

Continued on the next page

4. EXCESSIVE FUEL CONSUMPTION

Checkpoint	Trouble Cause	Countermeasure
Continued from the previous page		
OK		
Compression pressure	Blown out cylinder head gasket Worn cylinder liner Piston ring sticking or broken Improper seating between the valve and the valve seat	Replace the related parts
	NG	NG
OK		
Valve spring	Valve spring weak or broken	Replace the valve spring
	NG	NG

5. EXCESSIVE OIL CONSUMPTION

Checkpoint		Trouble Cause		Countermeasure
Engine oil	NG	Engine oil unsuitable Too much engine oil	NG	Replace the engine oil Correct the engine oil volume
OK				
Oil seal and gasket	NG	Oil leakage from the oil seal and/or the gasket	NG	Replace the oil seal and/or the gasket
OK				
Air breather	NG	Clogged air breather	NG	Clean the air breather
OK				
Inlet and exhaust valves Valve seals	NG	Defective valve seals Worn valves stems and valve guides	NG	Replace the valve seals, the valves, and the valve guides
OK				
Piston rings	NG	Piston rings worn, broken or improperly installed	NG	Replace the piston rings or properly install
OK				
Cylinder liners	NG	Cylinder lines scored or worn	NG	Replace the cylinder liners

6. OVERHEATING

Checkpoint		Trouble Cause		Countermeasure
Cooling water	NG	Insufficient cooling water	NG	Replenish the cooling water
OK				
Fan coupling (if so equipped)	NG	Oil leakage from the fan coupling	NG	Replace the fan coupling
OK				
Fan belt	NG	Fan belt loose or cracked causing slippage	NG	Replace the fan belt
OK				
Radiator	NG	Defective radiator cap or clogged radiator core	NG	Replace the radiator cap or clean the radiator core
OK				
Water pump	NG	Defective water pump	NG	Repair or replace the water pump
OK				
Cylinder head and cylinder body sealing cap	NG	Defective sealing cap resulting in water leakage	NG	Replace the sealing cap
OK				
Thermostat	NG	Defective thermostat	NG	Replace the thermostat

Continued on the next page

6. OVERHEATING

Checkpoint

Trouble Cause

Countermeasure

Continued from the previous page

OK

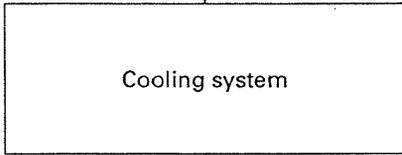

NG

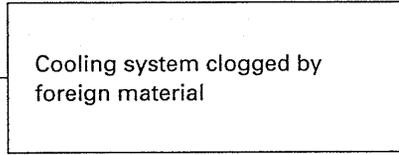

NG

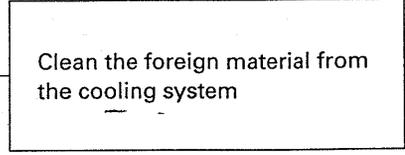

OK

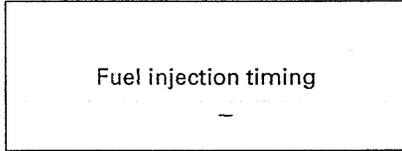

NG

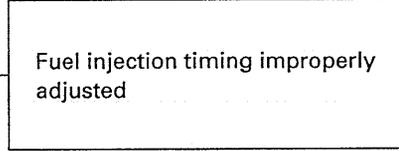

NG

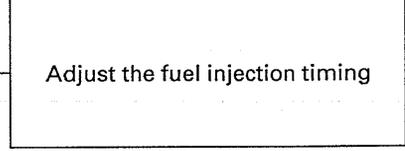

7. WHITE EXHAUST SMOKE

Checkpoint		Trouble Cause		Countermeasure
Fuel	NG	Water particles in the fuel	NG	Replace the fuel
OK				
Fuel injection timing	NG	Delayed fuel injection timing	NG	Adjust the fuel injection timing
OK				
Compression pressure	NG	Blown out cylinder head gasket Worn cylinder liner Piston ring sticking or broken Improper seating between the valve and the valve seat	NG	Replace the related parts
OK				
Inlet and exhaust valves Valve seals	NG	Defective valve seals Worn valves stems and valve guides	NG	Replace the valve seals, the valves, and the valve guides
OK				
Piston rings	NG	Piston rings worn, broken or improperly installed	NG	Replace the piston rings or properly install
OK				
Cylinder liners	NG	Cylinder lines scored or worn	NG	Replace the cylinder liners

8. DARK EXHAUST SMOKE

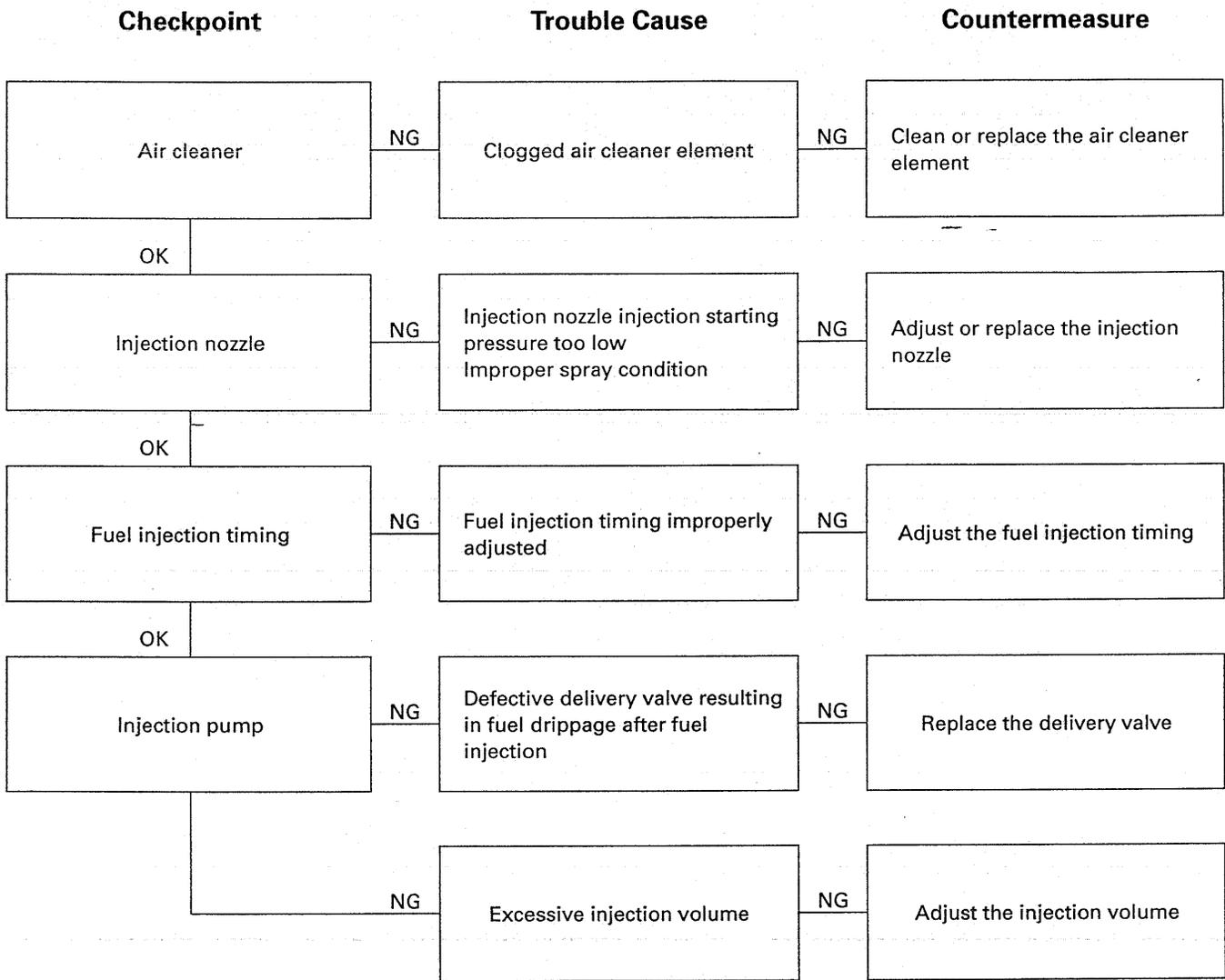

9. OIL PRESSURE DOES NOT RISE

Checkpoint		Trouble Cause		Countermeasure
Engine oil	NG	Improper viscosity engine oil Too much engine oil	NG	Replace the engine oil Correct the engine oil volume
OK				
Oil pressure gauge or unit Oil pressure indicator light	NG	Defective oil pressure gauge or unit Defective indicator light	NG	Repair or replace the oil pressure gauge or unit Replace the indicator light
OK				
Oil filter	NG	Clogged oil filter element	NG	Replace the oil filter element or the oil filter cartridge
OK				
Relief valve and by-pass valve	NG	Relief valve sticking and/or weak by-pass valve spring	NG	Replace the relief valve and/or the by-pass valve spring
OK				
Oil pump	NG	Clogged oil pump strainer	NG	Clean the oil pump strainer
OK				
	NG	Worn oil pump related parts	NG	Replace the oil pump related parts
OK				
Rocker arm shaft	NG	Worn rocker arm bushing	NG	Replace the rocker arm bushing

Continued on the next page

9. OIL PRESSURE DOES NOT RISE

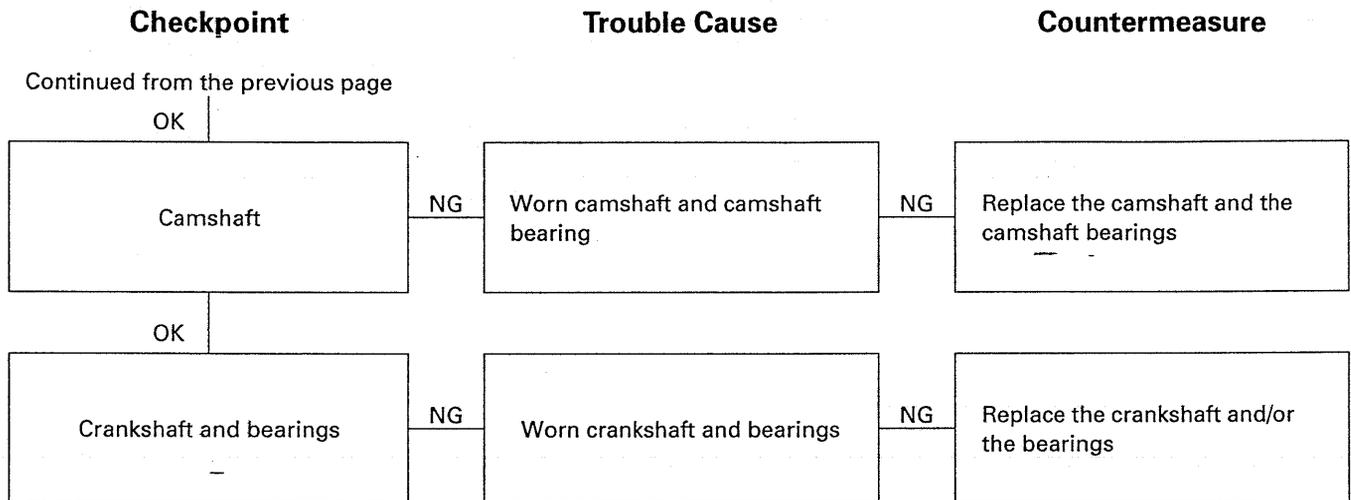

10. ABNORMAL ENGINE NOISE

1. Engine Knocking

Checkpoint

Trouble Cause

Countermeasure

Check to see that the engine has been thoroughly warmed up before beginning the troubleshooting procedure.

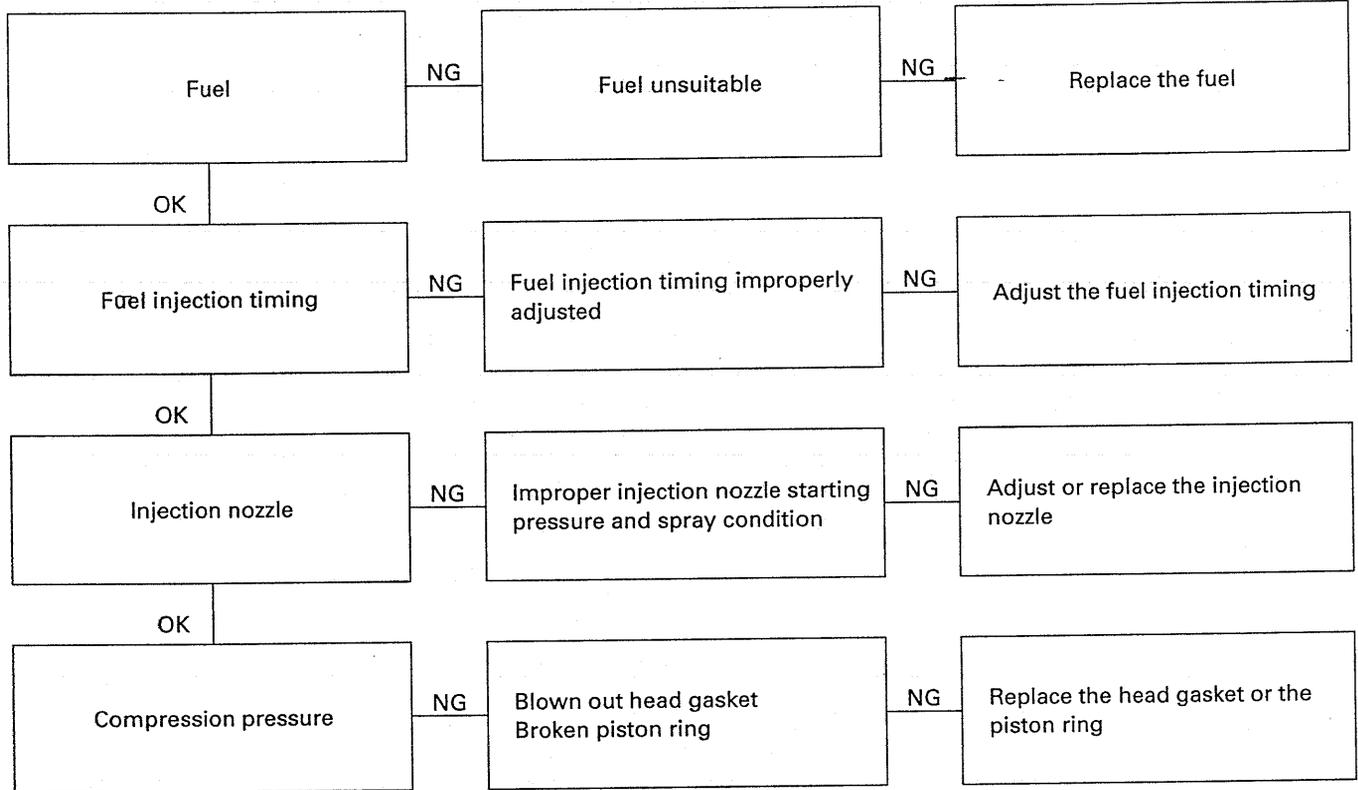

2. Gas Leakage Noise

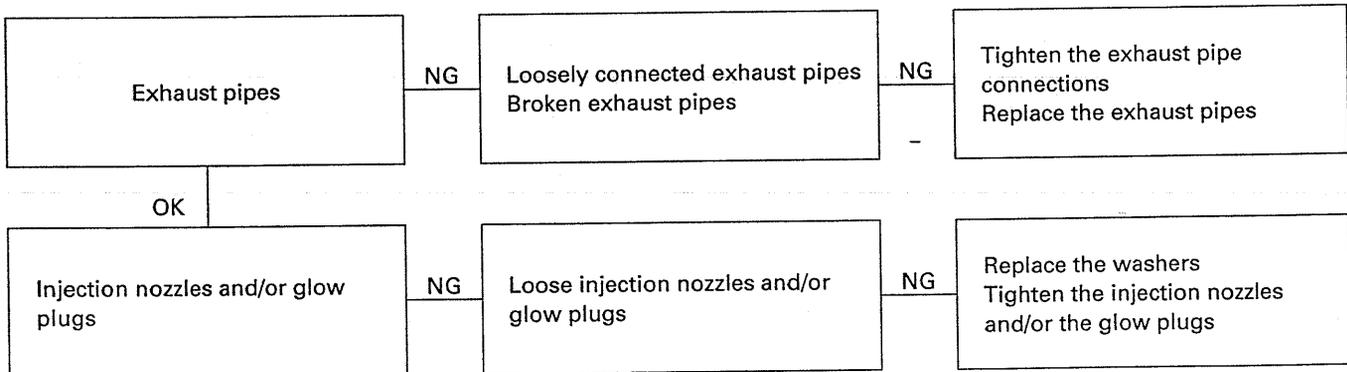

Continued on the next page

10. ABNORMAL ENGINE NOISE

2. Gas Leakage Noise

Checkpoint		Trouble Cause		Countermeasure
Continued from the previous page				
OK				
Exhaust manifold	NG	Loosely connected exhaust manifold and/or glow plugs	NG	Tighten the exhaust manifold connections
OK				
Cylinder head gasket	NG	Damaged cylinder head gasket	NG	Replace the cylinder head gasket

3. Continuous Noise

Fan belt	NG	Loose fan belt	NG	Readjust the fan belt tension
OK				
Cooling fan	NG	Loose cooling fan	NG	Retighten the cooling fan
OK				
Water pump bearing	NG	Worn or damaged water pump bearing	NG	Replace the water pump bearing
OK				
Alternator or vacuum pump	NG	Defective alternator or vacuum pump	NG	Repair or replace the alternator or the vacuum pump
OK				
Valve clearance	NG	Valve clearance improperly adjusted	NG	Adjust the valve clearance

10. ABNORMAL ENGINE NOISE

4. Slapping Noise

Checkpoint		Trouble Cause		Countermeasure
Valve clearance	NG	Valve clearance improperly adjusted	NG	Adjust the valve clearance
OK				
Rocker arm	NG	Damaged rocker arm	NG	Replace the rocker arm
OK				
Flywheel	NG	Loose flywheel bolts	NG	Retighten the flywheel bolts
OK				
Crankshaft and thrust bearings	NG	Worn or damaged crankshaft and/or thrust bearings	NG	Replace the crankshaft and/or the thrust bearings
OK				
Crankshaft and connecting rod bearings	NG	Worn or damaged crankshaft and/or connecting rod bearings	NG	Replace the crankshaft and/or the connecting rod bearings
OK				
Connecting rod bushing and piston pin	NG	Worn or damaged connecting rod bushing and piston pin	NG	Replace the connecting rod bushing and/or the piston pin
OK				
Piston and cylinder liner	NG	Worn or damaged piston and cylinder liner Foreign material in the cylinder	NG	Replace the piston and the cylinder liner

SECTION 11
SPECIAL TOOL LIST

SPECIAL TOOL LIST

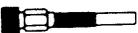
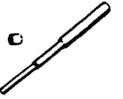
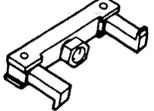
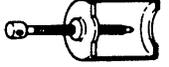
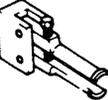
ITEM NO.	ILLUSTRATION	PART NO.	PARTS NAME	PAGE
1		5-8840-2008-1	Compression Gauge	27
2		5-8531-7001-0	Compression Gauge Adaptor	27
3		9-8523-1423-0	Valve Spring Compressor	44 89
4		9-8523-1212-0	Valve Guide Replacer	53 54
5		5-8840-2313-0	Cylinder Liner Installer	62
6		5-8840-2038-0	Camshaft Bearing Replacer	67 68
7		5-8840-0086-0	Camshaft Timing Gear Universal Puller	48 68
8		9-8840-2057-0	Crankshaft Timing Gear Remover	74
9		9-8522-0020-0	Crankshaft Timing Gear Installer	74
10		9-8840-2000-0	Crankshaft Pilot Bearing Remover	75

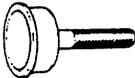
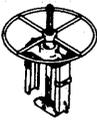
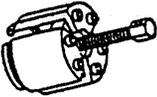
ITEM NO.	ILLUSTRATION	PART NO.	PARTS NAME	PAGE
11		5-8840-0019-0	Sliding Hammer	75
12		5-8522-0024-0	Crankshaft Pilot Bearing Installer	75
13		5-8840-2061-0	Crankshaft Front Oil Seal Installer	83
14		5-8840-2033-0	Valve Stem Oil Seal Installer	89
15		5-8840-0141-0	Crankshaft Rear Oil Seal Installer	102
16		5-8840-2304-0	Cylinder Liner Remover Ankle	60
17		9-8523-1169-0	Cylinder Liner Remover	60
18		5-8840-2362-0	Rear Oil Seal Remover	40
19		5-8840-2359-0	Rear Oil Seal Installer	103

SECTION 12

CONVERSION TABLES

INDEX

CONTENTS	PAGE
Length	203
Area	205
Volume	205
Mass	207
Pressure	208
Torque	209
Temperature	210

LENGTH

MILLIMETERS TO INCHES

mm	in.	mm	in.	mm	in.	mm	in.
1	0.0394	26	1.0236	51	2.0079	76	2.9921
2	0.0787	27	1.0630	52	2.0472	77	3.0315
3	0.1181	28	1.1024	53	2.0866	78	3.0709
4	0.1575	29	1.1417	54	2.1260	79	3.1102
5	0.1969	30	1.1811	55	2.1654	80	3.1496
6	0.2362	31	1.2205	56	2.2047	81	3.1890
7	0.2756	32	1.2598	57	2.2441	82	3.2283
8	0.3150	33	1.2992	58	2.2835	83	3.2677
9	0.3543	34	1.3386	59	2.3228	84	3.3071
10	0.3937	35	1.3780	60	2.3622	85	3.3465
11	0.4331	36	1.4173	61	2.4016	86	3.3858
12	0.4724	37	1.4567	62	2.4409	87	3.4252
13	0.5118	38	1.4961	63	2.4803	88	3.4646
14	0.5512	39	1.5354	64	2.5197	89	3.5039
15	0.5906	40	1.5748	65	2.5591	90	3.5433
16	0.6299	41	1.6142	66	2.5984	91	3.5827
17	0.6693	42	1.6535	67	2.6378	92	3.6220
18	0.7087	43	1.6929	68	2.6772	93	3.6614
19	0.7480	44	1.7323	69	2.7165	94	3.7008
20	0.7874	45	1.7717	70	2.7559	95	3.7402
21	0.8268	46	1.8110	71	2.7953	96	3.7795
22	0.8661	47	1.8504	72	2.8346	97	3.8189
23	0.9055	48	1.8898	73	2.8740	98	3.8583
24	0.9449	49	1.9291	74	2.9134	99	3.8976
25	0.9843	50	1.9685	75	2.9528	100	3.9370
101	3.9764	111	4.3701	121	4.7638	131	5.1575
102	4.0157	112	4.4094	122	4.8031	132	5.1968
103	4.0551	113	4.4488	123	4.8425	133	5.2362
104	4.0945	114	4.4882	124	4.8819	134	5.2756
105	4.1339	115	4.5276	125	4.9213	135	5.3150
106	4.1732	116	4.5669	126	4.9606	136	5.3543
107	4.2126	117	4.6063	127	5.0000	137	5.3937
108	4.2520	118	4.6457	128	5.0394	138	5.4331
109	4.2913	119	4.6850	129	5.0787	139	5.4724

INCHES TO MILLIMETERS

in.	mm	in.	mm
1/64	0.3969	33/64	13.0969
1/32	0.7938	17/32	13.4938
3/64	1.1906	35/64	13.8906
1/16	1.5875	9/16	14.2875
5/64	1.9844	37/64	14.6844
3/32	2.3813	19/32	15.0813
7/64	2.7781	39/64	15.4781
1/8	3.1750	5/8	15.8750
9/64	3.5719	41/64	16.2719
5/32	3.9688	21/32	16.6688
11/64	4.3656	43/64	17.0656
3/16	4.7625	11/16	17.4625
13/64	5.1594	45/64	17.8594
7/32	5.5563	23/32	18.2563
15/64	5.9531	47/64	18.6531
1/4	6.3500	3/4	19.0500
17/64	6.7469	49/64	19.4469
9/32	7.1438	25/32	19.8438
19/64	7.5406	51/64	20.2406
5/16	7.9375	13/16	20.6375
21/64	8.3344	53/64	21.0344
11/32	8.7313	27/32	21.4313
23/64	9.1281	55/64	21.8281
3/8	9.5250	7/8	22.2250
25/64	9.9219	57/64	22.6219
13/32	10.3188	29/32	23.0188
27/64	10.7156	59/64	23.4156
7/16	11.1125	15/16	23.8125
29/64	11.5094	61/64	24.2094
15/32	11.9063	31/32	24.6063
31/64	12.3031	63/64	25.0031
1/2	12.7000	1	25.4000

CONVERSION TABLE

LENGTH

FEET TO METERS

ft.	0	1	2	3	4	5	6	7	8	9	ft.
	m	m	m	m	m	m	m	m	m	m	
—		0.305	0.610	0.914	1.219	1.524	1.829	2.134	2.438	2.743	—
10	3.048	3.353	3.658	3.962	4.267	4.572	4.877	5.182	5.486	5.791	10
20	6.096	6.401	6.706	7.010	7.315	7.620	7.925	8.230	8.534	8.839	20
30	9.144	9.449	9.754	10.058	10.363	10.668	10.973	11.278	11.582	11.887	30
40	12.192	12.497	12.802	13.106	13.411	13.716	14.021	14.326	14.630	14.935	40
50	15.240	15.545	15.850	16.154	16.459	16.764	17.069	17.374	17.678	17.983	50
60	18.288	18.593	18.898	19.202	19.507	19.812	20.117	20.422	20.726	21.031	60
70	21.336	21.641	21.946	22.250	22.555	22.860	23.165	23.470	23.774	24.079	70
80	24.384	24.689	24.994	25.298	25.603	25.908	26.213	26.518	26.822	27.127	80
90	27.432	27.737	28.042	28.346	28.651	28.956	29.261	29.566	29.870	30.175	90
100	30.480	30.785	31.090	31.394	31.699	32.004	32.309	32.614	32.918	33.223	100

METERS TO FEET

m	0	1	2	3	4	5	6	7	8	9	m
	ft.	ft.	ft.	ft.	ft.	ft.	ft.	ft.	ft.	ft.	
—		3.2808	6.5617	9.8425	13.1234	16.4042	19.6850	22.9659	26.2467	29.5276	—
10	32.8084	36.0892	39.3701	42.6509	45.9318	49.2126	52.4934	55.7743	59.0551	62.3360	10
20	65.6168	68.8976	72.1785	75.4593	78.7402	82.0210	85.3018	88.5827	91.8635	95.1444	20
30	98.4252	101.7060	104.9869	108.2677	111.5486	114.8294	118.1102	121.3911	124.6719	127.9528	30
40	131.2336	134.5144	137.7953	141.0761	144.3570	147.6378	150.9186	154.1995	157.4803	160.7612	40
50	164.0420	167.3228	170.6037	173.8845	177.1654	180.4462	183.7270	187.0079	190.2887	193.5696	50
60	196.8504	200.1312	203.4121	206.6929	209.9738	213.2546	216.5354	219.8163	223.0971	226.3780	60
70	229.6588	232.9396	236.2205	239.5013	242.7822	246.0630	249.3438	252.6247	255.9055	259.1864	70
80	262.4672	265.7480	269.0289	272.3097	275.5906	278.8714	282.1522	285.4331	288.7139	291.9948	80
90	295.2756	298.5564	301.8373	305.1181	308.3990	311.6798	314.9606	318.2415	321.5223	324.8032	90
100	328.0840	331.3648	334.6457	337.9265	341.2074	344.4882	347.7690	351.0499	354.3307	357.6116	100

MILES TO KILOMETERS

miles	0	1	2	3	4	5	6	7	8	9	miles
	km	km	km	km	km	km	km	km	km	km	
—		1.609	3.219	4.828	6.437	8.047	9.656	11.265	12.875	14.484	—
10	16.093	17.703	19.312	20.921	22.531	24.140	25.750	27.359	28.968	30.578	10
20	32.187	33.796	35.406	37.015	38.624	40.234	41.843	43.452	45.062	46.671	20
30	48.280	49.890	51.499	53.108	54.718	56.327	57.936	59.546	61.155	62.764	30
40	64.374	65.983	67.592	69.202	70.811	72.420	74.030	75.639	77.249	78.858	40
50	80.467	82.077	83.686	85.295	86.905	88.514	90.123	91.733	93.342	94.951	50
60	96.561	98.170	99.779	101.389	103.000	104.607	106.217	107.826	109.435	111.045	60
70	112.654	114.263	115.873	117.482	119.091	120.700	122.310	123.919	125.529	127.138	70
80	128.748	130.357	131.966	133.576	135.185	136.794	138.404	140.013	141.622	143.232	80
90	144.841	146.450	148.060	149.669	151.278	152.888	154.497	156.106	157.716	159.325	90
100	160.934	162.544	164.153	165.762	167.372	168.981	170.590	172.200	173.809	175.418	100

KILOMETERS TO MILES

km	0	1	2	3	4	5	6	7	8	9	km
	miles	miles	miles	miles	miles	miles	miles	miles	miles	miles	
—		0.621	1.243	1.864	2.485	3.107	3.728	4.350	4.971	5.592	—
10	6.214	6.835	7.456	8.078	8.699	9.321	9.942	10.563	11.185	11.806	10
20	12.427	13.049	13.670	14.292	14.913	15.534	16.156	16.777	17.398	18.020	20
30	18.641	19.262	19.884	20.505	21.127	21.748	22.370	22.990	23.612	24.233	30
40	24.855	25.476	26.098	26.719	27.340	27.962	28.583	29.204	29.826	30.447	40
50	31.065	31.690	32.311	32.933	33.554	34.175	34.797	35.418	36.039	36.661	50
60	37.282	37.904	38.525	39.146	39.768	40.389	41.010	41.632	42.253	42.875	60
70	43.496	44.117	44.739	45.360	45.981	46.603	47.224	47.845	48.467	49.088	70
80	49.711	50.331	50.952	51.574	52.195	52.816	53.438	54.059	54.681	55.302	80
90	55.923	56.545	57.166	57.787	58.409	59.030	59.652	60.273	60.894	61.516	90
100	62.137	62.758	63.380	64.001	64.622	65.244	65.865	66.487	67.108	67.729	100

AREA

SQUARE INCHES TO SQUARE CENTIMETERS

in ²	0	1	2	3	4	5	6	7	8	9	in ²
	cm ²	cm ²	cm ²	cm ²	cm ²	cm ²	cm ²	cm ²	cm ²	cm ²	
—		6.452	12.903	19.355	25.806	32.258	38.710	45.161	51.613	58.064	—
10	64.516	70.968	77.419	83.871	90.322	96.774	103.226	109.677	116.129	122.580	10
20	129.032	135.484	141.935	148.387	154.838	161.290	167.742	174.193	180.645	187.096	20
30	193.548	200.000	206.451	212.903	219.354	225.806	232.258	238.709	245.161	251.612	30
40	258.064	264.516	270.967	277.419	283.870	290.322	296.774	303.225	309.677	316.128	40
50	322.580	329.032	335.483	341.935	348.386	354.838	361.290	367.741	374.193	380.644	50
60	387.096	393.548	399.999	406.451	412.902	419.354	425.806	432.257	438.709	445.160	60
70	451.612	458.064	464.515	470.967	477.418	483.870	490.322	496.773	503.225	509.676	70
80	516.128	522.580	529.031	535.483	541.934	548.386	554.838	561.289	567.741	574.192	80
90	580.644	587.096	593.547	599.999	606.450	612.902	619.354	625.805	632.257	638.708	90
100	645.160	651.612	658.063	664.515	670.966	677.418	683.870	690.312	696.773	703.224	100

SQUARE CENTIMETERS TO SQUARE INCHES

cm ²	0	1	2	3	4	5	6	7	8	9	cm ²
	in ²	in ²	in ²	in ²	in ²	in ²	in ²	in ²	in ²	in ²	
—		0.155	0.310	0.465	0.620	0.775	0.930	1.085	1.240	1.395	—
10	1.550	1.705	1.860	2.015	2.170	2.325	2.480	2.635	2.790	2.945	10
20	3.100	3.255	3.410	3.565	3.720	3.875	4.030	4.185	4.340	4.495	20
30	4.650	4.805	4.960	5.115	5.270	5.425	5.580	5.735	5.890	6.045	30
40	6.200	6.355	6.510	6.665	6.820	6.975	7.130	7.285	7.440	7.595	40
50	7.750	7.905	8.060	8.215	8.370	8.525	8.680	8.835	8.990	9.145	50
60	9.300	9.455	9.610	9.765	9.920	10.075	10.230	10.385	10.540	10.695	60
70	10.850	11.005	11.160	11.315	11.470	11.625	11.780	11.935	12.090	12.245	70
80	12.400	12.555	12.710	12.865	13.020	13.175	13.330	13.485	13.640	13.795	80
90	13.950	14.105	14.260	14.415	14.570	14.725	14.880	15.035	15.190	15.345	90
100	15.500	15.655	15.810	15.965	16.120	16.275	16.430	16.583	16.740	16.895	100

VOLUME

CUBIC INCHES TO CUBIC CENTIMETERS

in ³	0	1	2	3	4	5	6	7	8	9	in ³
	cm ³ (cc)	cm ³ (cc)	cm ³ (cc)	cm ³ (cc)	cm ³ (cc)	cm ³ (cc)	cm ³ (cc)	cm ³ (cc)	cm ³ (cc)	cm ³ (cc)	
—		16.387	32.774	49.161	65.548	81.935	98.322	114.709	131.097	147.484	—
10	163.871	180.258	196.645	213.032	229.419	245.806	262.193	278.580	294.967	311.354	10
20	327.741	344.128	360.515	376.902	393.290	409.677	426.064	442.451	458.838	475.225	20
30	491.612	507.999	524.386	540.773	557.160	573.547	589.934	606.321	622.708	639.095	30
40	655.483	671.870	688.257	704.644	721.031	737.418	753.805	770.192	786.579	802.966	40
50	819.353	835.740	852.127	868.514	884.901	901.289	917.676	934.063	950.450	966.837	50
60	983.224	999.611	1015.998	1032.385	1048.772	1065.159	1081.546	1097.933	1114.320	1130.707	60
70	1147.094	1163.482	1179.869	1196.256	1212.643	1229.030	1245.417	1261.804	1278.191	1294.578	70
80	1310.965	1327.352	1343.739	1360.126	1376.513	1392.900	1409.288	1425.675	1442.062	1458.449	80
90	1474.836	1491.223	1507.610	1523.997	1540.384	1556.771	1573.158	1589.545	1605.932	1622.319	90
100	1638.706	1655.093	1671.481	1687.868	1704.255	1720.642	1737.029	1753.416	1769.803	1786.190	100

CUBIC CENTIMETERS TO CUBIC INCHES

cm ³ (cc)	0	1	2	3	4	5	6	7	8	9	cm ³ (cc)
	in ³	in ³	in ³	in ³	in ³	in ³	in ³	in ³	in ³	in ³	
—		0.0610	0.1220	0.1831	0.2441	0.3051	0.3661	0.4272	0.4882	0.5492	—
10	0.6102	0.6713	0.7323	0.7933	0.8543	0.9153	0.9764	1.0374	1.0984	1.1594	10
20	1.2205	1.2815	1.3425	1.4035	1.4646	1.5256	1.5866	1.6476	1.7086	1.7697	20
30	1.8307	1.8917	1.9527	2.0138	2.0748	2.1358	2.1968	2.2579	2.3189	2.3799	30
40	2.4409	2.5020	2.5630	2.6240	2.6850	2.7460	2.8071	2.8681	2.9291	2.9901	40
50	3.0512	3.1122	3.1732	3.2342	3.2952	3.3563	3.4173	3.4783	3.5393	3.6004	50
60	3.6614	3.7224	3.7834	3.8444	3.9055	3.9665	4.0275	4.0885	4.1496	4.2106	60
70	4.2716	4.3326	4.3937	4.4547	4.5157	4.5767	4.6377	4.6988	4.7598	4.8208	70
80	4.8818	4.9429	5.0039	5.0649	5.1259	5.1870	5.2480	5.3090	5.3700	5.4310	80
90	5.4921	5.5531	5.6141	5.6751	5.7362	5.7972	5.8582	5.9192	5.9803	6.0413	90
100	6.1023	6.1633	6.2243	6.2854	6.3464	6.4074	6.4684	6.5295	6.5905	6.6515	100

CONVERSION TABLE

VOLUME

GALLONS (U.S.) TO LITERS

U.S. gal.	0	1	2	3	4	5	6	7	8	9	U.S. gal.
	liters	liters	liters	liters	liters	liters	liters	liters	liters	liters	
—		3.7854	7.5709	11.3563	15.1417	18.9271	22.7126	26.4980	30.2834	34.0633	—
10	37.8543	41.6397	45.4251	49.2105	52.9960	56.7814	60.5668	64.3523	68.1377	71.9231	10
20	75.7085	79.4940	83.2794	87.0648	90.8502	94.6357	98.4211	102.2065	105.9920	109.7774	20
30	113.5629	117.3482	121.1337	124.9191	128.7045	132.4901	136.2754	140.0608	143.8462	147.6316	30
40	151.4171	155.2025	158.9879	162.7734	166.5588	170.3442	174.1296	177.9151	181.7005	185.4859	40
50	189.2713	193.0568	196.8422	200.6276	204.4131	208.1985	211.9839	215.7693	219.5548	223.3402	50
60	227.1256	230.9110	234.6965	238.4819	242.2673	246.0527	249.8382	253.6236	257.4090	261.1945	60
70	264.9799	268.7653	272.5507	276.3362	280.1216	283.9070	287.6924	291.4779	295.2633	299.0487	70
80	302.8342	306.6196	310.4050	314.1904	317.9759	321.7613	325.5467	329.3321	333.1176	336.9030	80
90	340.6884	344.4738	348.2593	352.0447	355.8301	359.6156	363.4010	367.1864	370.9718	374.7573	90
100	378.5427	382.3281	386.1135	389.8990	393.6844	397.4698	401.2553	405.0407	408.8261	412.6115	100

LITERS TO GALLONS (U.S.)

liters	0	1	2	3	4	5	6	7	8	9	liters
	gal.	gal.	gal.	gal.	gal.	gal.	gal.	gal.	gal.	gal.	
—		0.2642	0.5283	0.7925	1.0567	1.3209	1.5850	1.8492	2.1134	2.3775	—
10	2.6417	2.9059	3.1701	3.4342	3.6984	3.9626	4.2268	4.4909	4.7551	5.0193	10
20	5.2834	5.5476	5.8118	6.0760	6.3401	6.6043	6.8685	7.1326	7.3968	7.6610	20
30	7.9252	8.1893	8.4535	8.7177	8.9818	9.2460	9.5102	9.7743	10.0385	10.3027	30
40	10.5669	10.8311	11.0952	11.3594	11.6236	11.8877	12.1519	12.4161	12.6803	12.9444	40
50	13.2086	13.4728	13.7369	14.0011	14.2653	14.5295	14.7936	15.0578	15.3220	15.5861	50
60	15.8503	16.1145	16.3787	16.6428	16.9070	17.1711	17.4354	17.6995	17.9637	18.2279	60
70	18.4920	18.7562	19.0204	19.2846	19.5487	19.8129	20.0771	20.3412	20.6054	20.8696	70
80	21.1338	21.3979	21.6621	21.9263	22.1904	22.4546	22.7188	22.9830	23.2471	23.5113	80
90	23.7755	24.0397	24.3038	24.5680	24.8322	25.0963	25.3605	25.6247	25.8889	26.1530	90
100	26.4172	26.6814	26.9455	27.2097	27.4739	27.7381	28.0022	28.2664	28.5306	28.7947	100

GALLONS (IMP.) TO LITERS

Imp gal.	0	1	2	3	4	5	6	7	8	9	Imp gal.
	liters	liters	liters	liters	liters	liters	liters	liters	liters	liters	
—		4.5459	9.0918	13.6377	18.1836	22.7295	27.2754	31.8213	36.3672	40.9131	—
10	45.4590	50.0049	54.5508	59.0967	63.6426	68.1885	72.7344	77.2803	81.8262	86.3721	10
20	90.9180	95.4639	100.0098	104.5557	109.1016	113.6475	118.1934	122.7393	127.2852	131.8311	20
30	136.3770	140.9229	145.4688	150.0147	154.5606	159.1065	163.6524	168.1983	172.7442	177.2901	30
40	181.8360	186.3819	190.9278	195.4737	200.0196	204.5655	209.1114	213.6573	218.2032	222.7491	40
50	227.2950	231.8409	236.3868	240.9327	245.4786	250.0245	254.5704	259.1163	263.6622	268.2081	50
60	272.7540	277.2999	281.8458	286.3917	290.9376	295.4835	300.0294	304.5753	309.1212	313.6671	60
70	318.2130	322.7589	327.3048	331.8507	336.3966	340.9425	345.4884	350.0343	354.5802	359.1261	70
80	363.6720	368.2179	372.7638	377.3097	381.8556	386.4015	390.9474	395.4933	400.0392	404.5851	80
90	409.1310	413.6769	418.2228	422.7687	427.3146	431.8605	436.4064	440.9523	445.4982	450.0441	90
100	454.5900	459.1359	463.6818	468.2277	472.7736	477.3195	481.8654	486.4113	490.9572	495.5031	100

LITERS TO GALLONS (IMP.)

liters	0	1	2	3	4	5	6	7	8	9	liter
	gal.	gal.	gal.	gal.	gal.	gal.	gal.	gal.	gal.	gal.	
—		0.2200	0.4400	0.6599	0.8799	1.0999	1.3199	1.5399	1.7598	1.9798	—
10	2.1998	2.4198	2.6398	2.8597	3.0797	3.2997	3.5197	3.7397	3.9596	4.1796	10
20	4.3996	4.6196	4.8396	5.0595	5.2795	5.4995	5.7195	5.9395	6.1594	6.3794	20
30	6.5994	6.8194	7.0394	7.2593	7.4793	7.6993	7.9193	8.1393	8.3592	8.5792	30
40	8.7992	9.0192	9.2392	9.4591	9.6791	9.8991	10.1191	10.3391	10.5590	10.7790	40
50	10.9990	11.2190	11.4390	11.6590	11.8789	12.0989	12.3189	12.5389	12.7588	12.9788	50
60	13.1988	13.4188	13.6388	13.8587	14.0787	14.2987	14.5187	14.7387	14.9586	15.1786	60
70	15.3986	15.6186	15.8386	16.0585	16.2785	16.4985	16.7185	16.9385	17.1584	17.3784	70
80	17.5984	17.8184	18.0384	18.2583	18.4783	18.6983	18.9183	19.1383	19.3582	19.5782	80
90	19.7982	20.0182	20.2382	20.4581	20.6781	20.8981	21.1181	21.3381	21.5580	21.7780	90
100	21.9980	22.2180	22.4380	22.6579	22.8779	23.0979	23.3179	23.5379	23.7578	23.9778	100

MASS

POUNDS TO KILOGRAMS

lbs.	0	1	2	3	4	5	6	7	8	9	lbs.
	kg	kg	kg	kg	kg	kg	kg	kg	kg	kg	
—		0.454	0.907	1.361	1.814	2.268	2.722	3.175	3.629	4.082	—
10	4.536	4.990	5.443	5.897	6.350	6.804	7.257	7.711	8.165	8.618	10
20	9.072	9.525	9.979	10.433	10.886	11.340	11.793	12.247	12.701	13.154	20
30	13.608	14.061	14.515	14.969	15.422	15.876	16.329	16.783	17.237	17.690	30
40	18.144	18.597	19.051	19.504	19.958	20.412	20.865	21.319	21.772	22.226	40
50	22.680	23.133	23.587	24.040	24.494	24.948	25.401	25.855	26.308	26.762	50
60	27.216	27.669	28.123	28.576	29.030	29.484	29.937	30.391	30.844	31.298	60
70	31.751	32.205	32.659	33.112	33.566	34.019	34.473	34.927	35.380	35.834	70
80	36.287	36.741	37.195	37.648	38.102	38.555	39.009	39.463	39.916	40.370	80
90	40.823	41.277	41.731	42.184	42.638	43.091	43.545	43.998	44.452	44.906	90
100	45.359	45.813	46.266	46.720	47.174	47.627	47.081	48.534	48.988	49.442	100

KILOGRAMS TO POUNDS

kg	0	1	2	3	4	5	6	7	8	9	kg
	lbs.	lbs.	lbs.	lbs.	lbs.	lbs.	lbs.	lbs.	lbs.	lbs.	
—		2.205	4.409	6.614	8.818	11.023	13.228	15.432	17.637	19.842	—
10	22.046	24.251	26.455	28.660	30.865	33.069	35.274	37.479	39.683	41.888	10
20	44.092	46.297	48.502	50.706	52.911	55.116	57.320	59.525	61.729	63.934	20
30	66.139	68.343	70.548	72.753	74.957	77.162	79.366	81.571	83.776	85.980	30
40	88.185	90.390	92.594	94.799	97.003	99.208	101.413	103.617	105.822	108.026	40
50	110.231	112.436	114.640	116.845	119.050	121.254	123.459	125.663	127.868	130.073	50
60	132.277	134.482	136.687	138.891	141.096	143.300	145.505	147.710	149.914	152.119	60
70	154.324	156.528	158.732	160.937	163.142	165.347	167.551	169.756	171.961	174.165	70
80	176.370	178.574	180.780	182.984	185.188	187.393	189.597	191.802	194.007	196.211	80
90	198.416	200.621	202.825	205.030	207.234	209.439	211.644	213.848	216.053	218.258	90
100	220.462	222.667	224.871	227.076	229.281	231.485	233.690	235.895	238.099	240.304	100

KILOGRAMS TO NEWTON

kg	0	1	2	3	4	5	6	7	8	9	kg
	N	N	N	N	N	N	N	N	N	N	
—	—	9.81	19.61	29.42	39.23	49.03	58.84	68.65	78.45	88.26	—
10	98.07	107.87	117.68	127.49	137.29	147.10	156.91	166.71	176.52	186.33	10
20	196.13	205.94	215.75	225.55	235.36	245.17	254.97	264.78	274.59	284.39	20
30	294.20	304.01	313.81	323.62	333.43	343.23	353.04	362.85	372.65	382.46	30
40	392.27	402.07	411.88	421.69	431.49	441.30	451.11	460.91	470.72	480.53	40
50	490.33	500.14	509.95	519.75	529.56	539.37	549.17	558.98	568.79	578.59	50
60	588.40	598.21	608.01	617.82	627.63	637.43	647.24	657.05	666.85	676.66	60
70	686.47	696.27	706.08	715.89	725.69	735.50	745.31	755.11	764.92	774.73	70
80	784.53	794.34	804.15	813.95	823.76	833.57	843.37	853.18	862.99	872.79	80
90	882.60	892.41	902.21	912.02	921.83	931.63	941.44	951.25	961.05	970.86	90
100	980.67	990.47	1000.28	1010.08	1019.89	1029.70	1039.50	1049.31	1059.12	1068.92	100

NEWTON TO KILOGRAMS

N	0	10	20	30	40	50	60	70	80	90	N
	kg	kg	kg	kg	kg	kg	kg	kg	kg	kg	
—	—	1.020	2.039	3.059	4.079	5.099	6.118	7.138	8.158	9.177	—
100	10.197	11.217	12.237	13.256	14.276	15.296	16.316	17.335	18.355	19.375	100
200	20.394	21.414	22.434	23.453	24.473	25.493	26.513	27.532	28.552	29.572	200
300	30.592	31.611	32.631	33.651	34.670	35.690	36.710	37.730	38.749	39.769	300
400	40.789	41.809	42.828	43.848	44.868	45.887	46.907	47.927	48.947	49.966	400
500	50.986	52.006	53.025	54.045	55.065	56.085	57.104	58.124	59.144	60.163	500
600	61.183	62.203	63.223	64.242	65.262	66.282	67.302	68.321	69.341	70.361	600
700	71.380	72.400	73.420	74.440	75.459	76.479	77.499	78.518	79.538	80.558	700
800	81.578	82.597	83.617	84.637	85.656	86.676	87.696	88.716	89.735	90.755	800
900	91.775	92.795	93.814	94.834	95.854	96.873	97.893	98.913	99.933	100.952	900
1000	101.972	102.992	104.011	105.031	106.051	107.071	108.090	109.110	110.130	111.149	1000

CONVERSION TABLE

PRESSURE

POUNDS PER SQUARE INCHES TO KILOGRAMS PER SQUARE CENTIMETERS

lb/in ²	0	1	2	3	4	5	6	7	8	9	lb/in ²
(psi)	kg/cm ²	kg/cm ²	kg/cm ²	kg/cm ²	kg/cm ²	kg/cm ²	kg/cm ²	kg/cm ²	kg/cm ²	kg/cm ²	(psi)
—		0.0703	0.1406	0.2109	0.2812	0.3515	0.4218	0.4921	0.5625	0.6328	—
10	0.7031	0.7734	0.8437	0.9140	0.9843	1.0546	1.1249	1.1952	1.2655	1.3358	10
20	1.4061	1.4764	1.5468	1.6171	1.6874	1.7577	1.8280	1.8983	1.9686	2.0389	20
30	2.1092	2.1795	2.2498	2.3201	2.3904	2.4607	2.5311	2.6014	2.6717	2.7420	30
40	2.8123	2.8826	2.9529	3.0232	3.0935	3.1638	3.2341	3.3044	3.3747	3.4450	40
50	3.5154	3.5857	3.6560	3.7263	3.7966	3.8669	3.9372	4.0075	4.0778	4.1481	50
60	4.2184	4.2887	4.3590	4.4293	4.4996	4.5700	4.6403	4.7106	4.7809	4.8512	60
70	4.9215	4.9918	5.0621	5.1324	5.2027	5.2730	5.3433	5.4136	5.4839	5.5543	70
80	5.6246	5.6947	5.7652	5.8355	5.9058	5.9761	6.0464	6.1167	6.1870	6.2573	80
90	6.3276	6.3979	6.4682	6.5386	6.6089	6.6792	6.7495	6.8198	6.8901	6.9604	90
100	7.0307	7.1010	7.1713	7.2416	7.3119	7.3822	7.4525	7.5228	7.5932	7.6635	100

KILOGRAMS PER SQUARE CENTIMETERS TO POUNDS PER SQUARE INCHES

kg/cm ²	0	1	2	3	4	5	6	7	8	9	kg/cm ²
	lb/in ² (psi)	lb/in ² (psi)	lb/in ² (psi)	lb/in ² (psi)	lb/in ² (psi)	lb/in ² (psi)	lb/in ² (psi)	lb/in ² (psi)	lb/in ² (psi)	lb/in ² (psi)	
—		14.22	28.45	42.67	56.89	71.12	85.34	99.56	113.78	128.01	—
10	142.23	156.45	170.68	184.90	199.12	213.35	227.57	241.79	256.01	270.24	10
20	284.46	298.68	312.91	327.13	341.35	355.58	369.80	384.02	398.24	412.47	20
30	426.69	440.91	455.14	469.36	483.58	497.81	512.03	526.25	540.47	554.70	30
40	568.92	583.14	597.37	611.59	625.81	640.04	654.26	668.48	682.70	696.93	40
50	711.16	725.37	739.60	753.82	768.04	782.27	796.49	810.71	824.93	839.16	50
60	853.38	867.60	881.83	896.05	910.27	924.50	938.72	952.94	967.16	981.39	60
70	995.61	1009.83	1024.06	1038.28	1052.50	1066.73	1080.95	1095.17	1109.39	1123.62	70
80	1137.84	1152.06	1166.27	1180.51	1194.73	1208.96	1223.18	1237.40	1251.62	1265.85	80
90	1280.07	1294.20	1308.52	1322.74	1336.96	1351.19	1365.41	1379.63	1393.85	1408.08	90
100	1422.30	1436.52	1450.75	1464.97	1479.19	1493.42	1507.64	1521.86	1536.08	1550.31	100

KILOGRAMS PER SQUARE CENTIMETERS TO KILO PASCAL

kg/cm ²	0	1	2	3	4	5	6	7	8	9	kg/cm ²
	KPa	KPa	KPa	KPa	KPa	KPa	KPa	KPa	KPa	KPa	
—	—	98.1	196.1	294.2	392.3	490.3	588.4	686.5	784.5	882.6	—
10	980.7	1078.7	1176.8	1274.9	1372.9	1471.0	1569.1	1667.1	1765.2	1863.3	10
20	1961.3	2059.4	2157.5	2255.6	2353.6	2451.7	2549.7	2647.8	2745.9	2843.9	20
30	2942.0	3040.1	3138.1	3236.2	3334.3	3432.3	3530.4	3628.5	3726.5	3824.6	30
40	3922.7	4020.7	4118.8	4216.9	4314.9	4413.0	4511.1	4609.1	4707.2	4805.3	40
50	4903.3	5001.4	5099.5	5197.5	5295.6	5393.7	5491.7	5589.8	5687.9	5785.9	50
60	5884.0	5982.1	6080.1	6178.2	6276.3	6374.3	6472.4	6570.5	6668.5	6766.6	60
70	6864.7	6962.7	7060.8	7158.9	7256.9	7355.0	7453.1	7551.1	7649.2	7747.3	70
80	7845.3	7943.4	8041.5	8139.5	8237.6	8335.7	8433.7	8531.8	8629.9	8727.9	80
90	8826.0	8924.1	9022.1	9120.2	9218.3	9316.3	9414.4	9512.5	9610.5	9708.6	90
100	9806.7	9904.7	10002.8	10100.8	10198.9	10297.0	10395.0	10493.1	10591.2	10689.2	100

KILO PASCAL TO KILOGRAMS PER SQUARE CENTIMETERS

KPa	0	100	200	300	400	500	600	700	800	900	KPa
	kg/cm ²	kg/cm ²	kg/cm ²	kg/cm ²	kg/cm ²	kg/cm ²	kg/cm ²	kg/cm ²	kg/cm ²	kg/cm ²	
—	—	1.020	2.039	3.059	4.079	5.099	6.118	7.138	8.158	9.177	—
1000	10.197	11.217	12.237	13.256	14.276	15.296	16.316	17.335	18.355	19.375	1000
2000	20.394	21.414	22.434	23.453	24.473	25.493	26.513	27.532	28.552	29.572	2000
3000	30.592	31.611	32.631	33.651	34.670	35.690	36.710	37.730	38.749	39.769	3000
4000	40.789	41.809	42.828	43.848	44.868	45.887	46.907	47.927	48.947	49.966	4000
5000	50.986	52.006	53.025	54.045	55.065	56.085	57.104	58.124	59.144	60.163	5000
6000	61.183	62.203	63.223	64.242	65.262	66.282	67.302	68.321	69.341	70.361	6000
7000	71.380	72.400	73.420	74.440	75.459	76.479	77.499	78.518	79.538	80.558	7000
8000	81.578	82.597	83.617	84.637	85.656	86.676	87.696	88.716	89.735	90.755	8000
9000	91.775	92.794	93.814	94.834	95.854	96.873	97.893	98.913	99.933	100.952	9000
10000	101.972	102.992	104.011	105.031	106.051	107.071	108.090	109.110	110.130	111.149	10000

TORQUE

FOOT POUNDS TO KILOGRAMMETERS

ft. lbs.	0	1	2	3	4	5	6	7	8	9	ft. lbs.
	kg-m	kg-m	kg-m	kg-m	kg-m	kg-m	kg-m	kg-m	kg-m	kg-m	
—		0.138	0.277	0.415	0.553	0.691	0.830	0.968	1.106	1.244	—
10	1.383	1.521	1.659	1.797	1.936	2.074	2.212	2.350	2.489	2.627	10
20	2.765	2.903	3.042	3.180	3.318	3.456	3.595	3.733	3.871	4.009	20
30	4.148	4.286	4.424	4.562	4.700	4.839	4.977	5.115	5.253	5.392	30
40	5.530	5.668	5.807	5.945	6.083	6.221	6.360	6.498	6.636	6.774	40
50	6.913	7.051	7.189	7.328	7.466	7.604	7.742	7.881	8.019	8.157	50
60	8.295	8.434	8.572	8.710	8.848	8.987	9.125	9.263	9.401	9.540	60
70	9.678	9.816	9.954	10.093	10.231	10.369	10.507	10.646	10.784	10.922	70
80	11.060	11.199	11.337	11.475	11.613	11.752	11.890	12.028	12.166	12.305	80
90	12.442	12.581	12.719	12.858	12.996	13.134	13.272	13.410	13.549	13.687	90
100	13.826	13.964	14.102	14.240	14.379	14.517	14.655	14.793	14.932	15.070	100

KILOGRAMMETERS TO FOOT POUNDS

kg-m	0	1	2	3	4	5	6	7	8	9	kg-m
	ft. lbs.	ft. lbs.	ft. lbs.	ft. lbs.	ft. lbs.	ft. lbs.	ft. lbs.	ft. lbs.	ft. lbs.	ft. lbs.	
—		7.23	14.47	21.70	28.93	36.17	43.40	50.63	57.86	65.10	—
10	72.33	79.56	86.80	94.03	101.26	108.50	115.73	122.96	130.19	137.43	10
20	144.66	151.89	159.13	166.36	173.59	180.83	188.06	195.29	202.52	209.76	20
30	217.00	224.22	231.46	238.69	245.92	253.16	260.39	267.62	274.85	282.09	30
40	289.32	296.55	303.79	311.02	318.25	325.49	332.72	339.95	347.18	354.42	40
50	361.65	368.88	376.12	383.35	390.58	397.82	405.05	412.28	419.51	426.75	50
60	433.98	441.21	448.45	455.68	462.91	470.15	477.38	484.61	491.84	499.08	60
70	506.31	513.54	520.78	528.01	535.24	542.48	549.71	556.94	564.17	571.41	70
80	578.64	585.87	593.11	600.34	607.57	614.81	622.04	629.27	636.50	643.74	80
90	650.97	658.20	665.44	672.67	679.90	687.14	694.37	701.60	708.83	716.07	90
100	723.30	730.53	737.77	745.00	752.23	759.47	766.70	773.93	781.16	788.40	100

KILOGRAMMETERS TO NEWTONMETERS

kg-m	0	1	2	3	4	5	6	7	8	9	kg-m
	N-m	N-m	N-m	N-m	N-m	N-m	N-m	N-m	N-m	N-m	
—	—	9.81	19.61	29.42	39.23	49.03	58.84	68.65	78.45	88.26	—
10	98.07	107.87	117.68	127.49	137.29	147.10	156.91	166.71	176.52	186.33	10
20	196.13	205.94	215.75	225.55	235.36	245.17	254.97	264.78	274.59	284.39	20
30	294.20	304.01	313.81	323.62	333.43	343.23	353.04	362.85	372.65	382.46	30
40	392.27	402.07	411.88	421.69	431.49	441.30	451.11	460.91	470.72	480.53	40
50	490.33	500.14	509.95	519.75	529.56	539.37	549.17	558.98	568.79	578.59	50
60	588.40	598.21	608.01	617.82	627.63	637.43	647.24	657.05	666.85	676.66	60
70	686.47	696.27	706.08	715.89	725.69	735.50	745.31	755.11	764.92	774.73	70
80	784.53	794.34	804.15	813.95	823.76	833.57	843.37	853.18	862.99	872.79	80
90	882.60	892.41	902.21	912.02	921.83	931.63	941.44	951.25	961.05	970.86	90
100	980.67	990.47	1000.28	1010.08	1019.89	1029.70	1039.50	1049.31	1059.12	1068.92	100

NEWTONMETERS TO KILOGRAMMETERS

N-m	0	10	20	30	40	50	60	70	80	90	N-m
	kg-m	kg-m	kg-m	kg-m	kg-m	kg-m	kg-m	kg-m	kg-m	kg-m	
—	—	1.020	2.039	3.059	4.079	5.099	6.118	7.138	8.158	9.177	—
100	10.197	11.217	12.236	13.256	14.276	15.296	16.315	17.335	18.355	19.374	100
200	20.394	21.414	22.433	23.453	24.473	25.493	26.512	27.532	28.552	29.571	200
300	30.591	31.611	32.630	33.650	34.670	35.690	36.710	37.729	38.749	39.768	300
400	40.789	41.808	42.827	43.847	44.867	45.887	46.906	47.926	48.946	49.965	400
500	50.986	52.005	53.024	54.044	55.064	56.084	57.103	58.123	59.143	60.162	500
600	61.183	62.202	63.221	64.241	65.261	66.281	67.300	68.320	69.340	70.359	600
700	71.380	72.399	73.418	74.438	75.458	76.478	77.497	78.517	79.537	80.556	700
800	81.577	82.596	83.615	84.635	85.655	86.675	87.694	88.714	89.734	90.753	800
900	91.774	92.793	93.812	94.832	95.852	96.872	97.891	98.911	99.931	100.950	900
1000	101.972	102.990	104.009	105.029	106.049	107.069	108.088	109.108	110.128	111.147	1000

CONVERSION TABLE

TEMPERATURE

FAHRENHEIT TO CENTIGRADE

°F	°C	°F	°C	°F	°C	°F	°C	°F	°C	°F	°C	°F	°C	°F	°C
-60	-51.1	-2	-18.9	56	13.3	114	45.6	172	77.8	230	110.0	288	142.2	346	174.4
-58	-50	0	-17.8	58	14.4	116	46.7	174	78.9	232	111.1	290	143.3	348	175.6
-56	-48.9	2	-16.7	60	15.6	118	47.8	176	80.0	234	112.2	292	144.4	350	176.7
-54	-47.8	4	-15.6	62	16.7	120	48.9	178	81.1	236	113.3	294	145.6	352	177.8
-52	-46.7	6	-14.4	64	17.8	122	50.0	180	82.2	238	114.4	296	146.7	354	178.9
-50	-45.6	8	-13.3	66	18.9	124	51.1	182	83.3	240	115.6	298	147.8	356	180.0
-48	-44.4	10	-12.2	68	20.0	126	52.2	184	84.4	242	116.7	300	148.9	358	181.1
-46	-43.3	12	-11.1	70	21.1	128	53.3	186	85.6	244	117.8	302	150.0	360	182.2
-44	-42.2	14	-10.0	72	22.2	130	54.4	188	86.7	246	118.9	304	151.1	362	183.3
-42	-41.1	16	-8.9	74	23.3	132	55.6	190	87.8	248	120.0	306	152.2	364	184.4
-40	-40.0	18	-7.8	76	24.9	134	56.7	192	88.9	250	121.1	308	153.3	366	185.6
-38	-38.9	20	-6.7	78	25.6	136	57.8	194	90.0	252	122.2	310	154.4	368	186.7
-36	-37.8	22	-5.6	80	26.7	138	58.9	196	91.1	254	123.3	312	155.6	370	187.8
-34	-36.7	24	-4.4	82	27.8	140	60.0	198	92.2	256	124.4	314	156.7	372	188.9
-32	-35.6	26	-3.3	84	28.9	142	61.1	200	93.3	258	125.6	316	157.8	374	190.0
-30	-34.4	28	-2.2	86	30.0	144	62.2	202	94.4	260	126.7	318	158.9	376	191.1
-28	-33.3	30	-1.1	88	31.1	146	63.3	204	95.6	262	127.8	320	160.0	378	192.2
-26	-32.2	32	0	90	32.2	148	64.4	206	96.7	264	128.9	322	161.1	380	193.3
-24	-31.1	34	1.1	92	33.3	150	65.6	208	97.8	266	130.0	324	162.2	382	194.4
-22	-30.0	36	2.2	94	34.4	152	66.7	210	98.9	268	131.1	326	163.3	384	195.6
-20	-28.9	38	3.3	96	35.6	154	67.8	212	100.0	270	132.2	328	164.4	386	196.7
-18	-27.8	40	4.4	98	36.7	156	68.9	214	101.1	272	133.3	330	165.6	388	197.8
-16	-26.7	42	5.6	100	37.8	158	70.0	216	102.2	274	134.4	332	166.7	390	198.9
-14	-25.6	44	6.7	102	38.9	160	71.1	218	103.3	276	135.6	334	167.8	392	200.0
-12	-24.4	46	7.8	104	40.0	162	72.2	220	104.4	278	136.7	336	168.9	400	204.4
-10	-23.3	48	8.9	106	41.1	164	73.3	222	105.6	280	137.8	338	170.0	410	210.0
-8	-22.2	50	10.0	108	42.2	166	74.4	224	106.7	282	138.9	340	171.1	420	215.6
-6	-21.1	52	11.1	110	43.3	168	75.6	226	107.8	284	140.0	342	172.2	430	221.1
-4	-20.0	54	12.2	112	44.4	170	76.7	228	108.9	286	141.1	344	173.3	440	226.7

CENTIGRADE TO FAHRENHEIT

°C	°F	°C	°F	°C	°F	°C	°F	°C	°F	°C	°F	°C	°F	°C	°F
-50	-58.0	-18	-0.4	14	57.2	46	114.8	78	172.4	110	230.0	142	287.6	174	345.2
-49	-56.2	-17	1.4	15	59.0	47	116.6	79	174.2	111	231.8	143	289.4	175	347.0
-48	-54.4	-16	3.2	16	60.8	48	118.4	80	176.0	112	233.6	144	291.2	176	348.8
-47	-52.6	-15	5.0	17	62.6	49	120.2	81	177.8	113	235.4	145	293.0	177	350.6
-46	-50.8	-14	6.8	18	64.4	50	122.0	82	179.6	114	237.2	146	294.8	178	352.4
-45	-49.0	-13	8.6	19	66.2	51	123.8	83	181.4	115	239.0	147	296.6	179	354.2
-44	-47.2	-12	10.4	20	68.0	52	125.6	84	183.2	116	240.8	148	298.4	180	356.0
-43	-45.4	-11	12.2	21	69.8	53	127.4	85	185.0	117	242.6	149	300.2	181	357.8
-42	-43.6	-10	14.0	22	71.6	54	129.2	86	186.8	118	244.4	150	302.0	182	359.6
-41	-41.8	-9	15.8	23	73.4	55	131.0	87	188.6	119	246.2	151	303.8	183	361.4
-40	-40.0	-8	17.6	24	75.2	56	132.8	88	190.4	120	248.0	152	305.6	184	363.2
-39	-38.2	-7	19.4	25	77.0	57	134.6	89	192.2	121	249.8	153	307.4	185	365.0
-38	-36.4	-6	21.2	26	78.8	58	136.4	90	194.0	122	251.6	154	309.2	186	366.8
-37	-34.6	-5	23.0	27	80.6	59	138.2	91	195.8	123	253.4	155	311.0	187	368.6
-36	-32.8	-4	24.8	28	82.4	60	140.0	92	197.6	124	255.2	156	312.8	188	370.4
-35	-31.0	-3	26.6	29	84.2	61	141.8	93	199.4	125	257.0	157	314.6	189	372.2
-34	-29.2	-2	28.4	30	86.0	62	143.6	94	201.2	126	258.8	158	316.4	190	374.0
-33	-27.4	-1	30.2	31	87.8	63	145.4	95	203.0	127	260.6	159	318.2	191	375.8
-32	-25.6	0	32.0	32	89.6	64	147.2	96	204.8	128	262.4	160	320.0	192	377.6
-31	-23.8	1	33.8	33	91.4	65	149.0	97	206.6	129	264.2	161	321.8	193	379.4
-30	-22.0	2	35.6	34	93.2	66	150.8	98	208.4	130	266.0	162	323.6	194	381.2
-29	-20.2	3	37.4	35	95.0	67	152.6	99	210.2	131	267.8	163	325.4	195	383.0
-28	-18.4	4	39.2	36	96.8	68	154.4	100	212.0	132	269.6	164	327.2	196	384.8
-27	-16.6	5	41.0	37	98.6	69	156.2	101	213.8	133	271.4	165	329.0	197	386.6
-26	-14.8	6	42.8	38	100.4	70	158.0	102	215.6	134	273.2	166	330.8	198	388.4
-25	-13.0	7	44.6	39	102.2	71	159.8	103	217.4	135	275.0	167	332.6	199	390.2
-24	-11.2	8	46.4	40	104.0	72	161.6	104	219.2	136	276.8	168	334.4	200	392.0
-23	-9.4	9	48.2	41	105.8	73	163.4	105	221.0	137	278.6	169	336.2	210	410.0
-22	-7.6	10	50.0	42	107.6	74	165.2	106	222.8	138	280.4	170	338.0	220	428.0
-21	-5.8	11	51.8	43	109.4	75	167.0	107	224.6	139	282.2	171	339.8	230	446.0
-20	-4.4	12	53.6	44	111.2	76	168.8	108	226.4	140	284.0	172	341.6	240	464.0
-19	-2.2	13	55.4	45	113.0	77	170.6	109	228.2	141	285.8	173	343.4	250	482.0

ALUMINUM DYECAST TYPE TIMING GEARCASE PTO INSTALLATION PROCEDURE

GEARCASE PTO AND RELATED PARTS

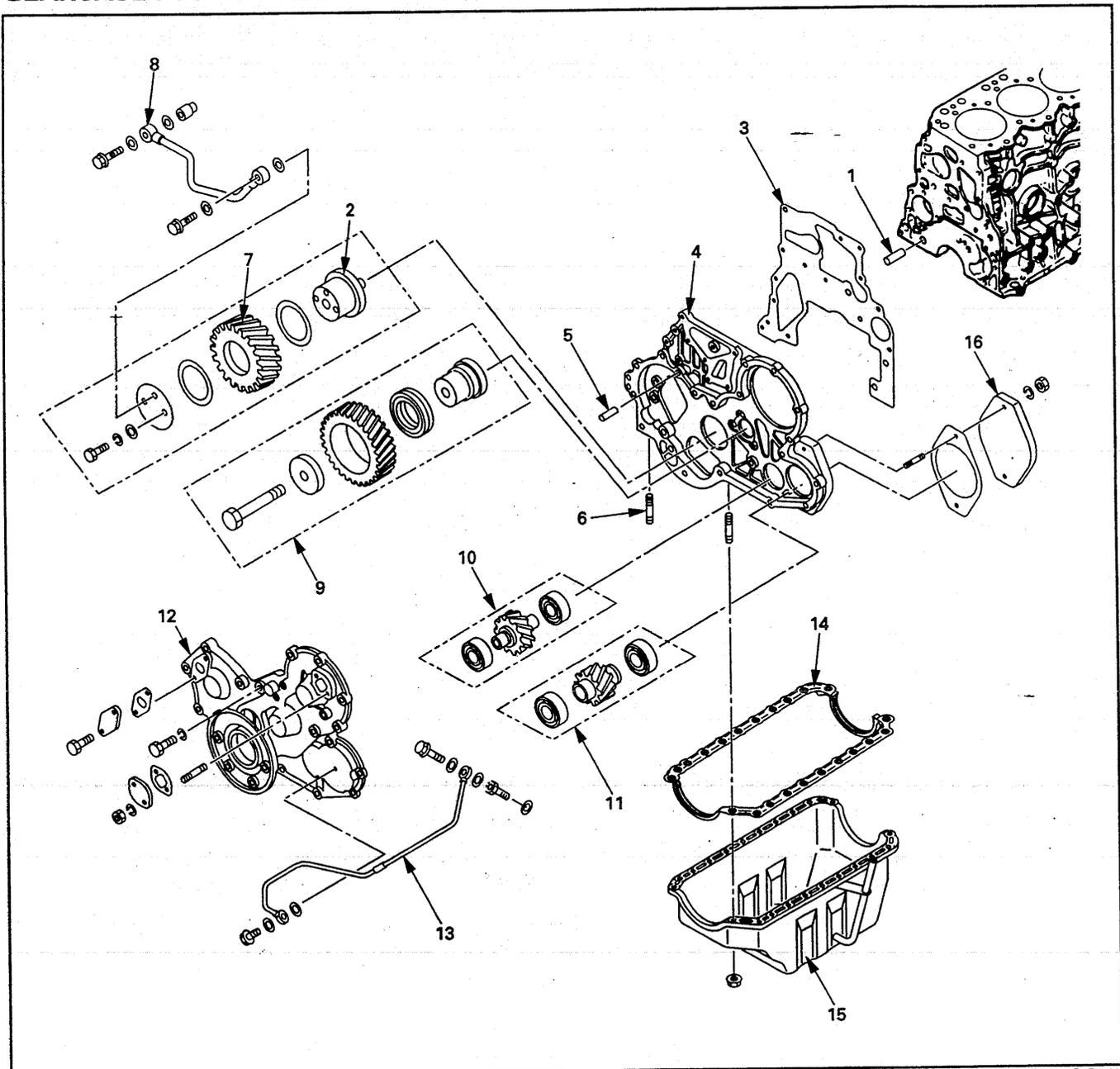

Reassembly Steps – 2b: Timing Gearcase PTO

- | | |
|-----------------------|--------------------|
| 1. Locating pin | 9. Idler gear B |
| 2. Idler gear shaft A | 10. Idler gear C |
| 3. Gasket | 11. PTO gear |
| 4. Gearcase | 12. Gearcase cover |
| 5. Locating pin | 13. Oil feed pipe |
| 6. Stud bolt | 14. Gasket |
| 7. Idler gear A | 15. Oil pan |
| 8. Oil pipe | 16. Cover |

F08E100046

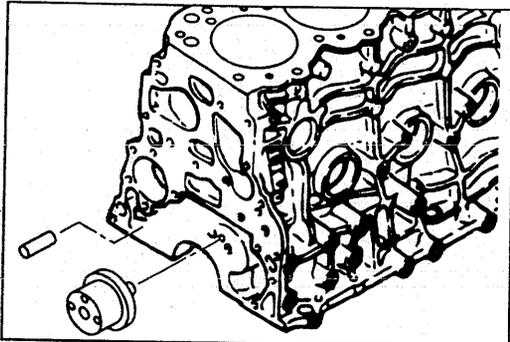

014E100055

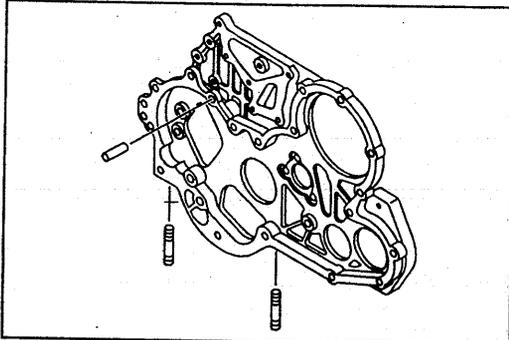

020E100018

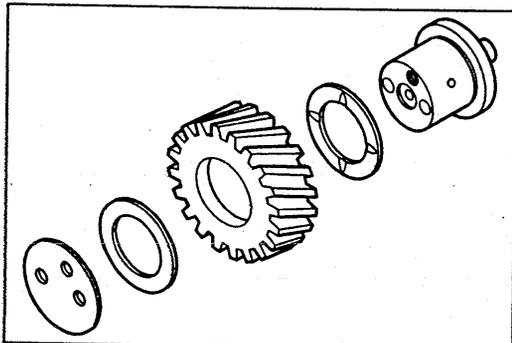

014E100066

Idler gear shaft

1. Install the idler gear shaft A with facing up oil hole to the cylinder block.
2. Install the locating pin to the cylinder block.

Note:

The gearcase is positioned by the locating pin and idler gear shaft A.

Gearcase

1. Install the gearcase with new gasket to the cylinder block. Tighten the bolts to the specified torque.

N·m (kgf·m/lb.ft)

Gearcase Bolt Torque	14 – 24 (1.4 – 2.4/10 – 17)
----------------------	-----------------------------

2. Install the locating pin to the gearcase.
3. Install the stud bolts to the gearcase.
 - Apply Loctite 262 or equivalent to the thread portion of stud bolt.

Idler gear A

1. Install the camshaft with cam gear.
2. Install the idler gear and thrust washer to the idler gear shaft.
 - Apply engine oil to the idler gear shaft.
 - Install the thrust washers with the dimple of thrust washer facing to gear side.
 - Tighten the bolts to the specified torque.

N·m (kgf·m/lb.ft)

Bolt Torque	14 – 24 (1.4 – 2.4/10 – 17)
-------------	-----------------------------

3. Install the oil pipe (gearcase to idler gear shaft). Tighten the bolts to the specified torque.

N·m (kgf·m/lb.ft)

Bolt Torque	10 – 15 (1.0 – 1.5/7.2 – 11)
-------------	------------------------------

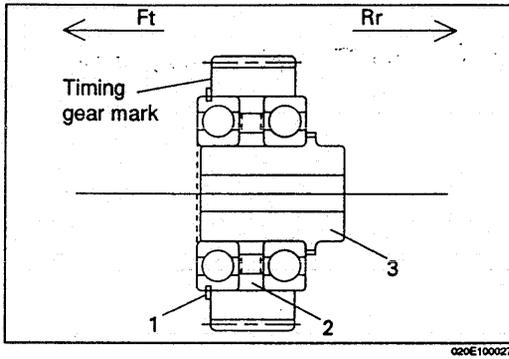

Idler gear B

1. Press the bearing to the idler gear until the gear contacts into bearing stopper (1).
 - Use the bearing with spacers (2).
 - Apply load only on the outer race of bearing, when the bearing will be pressed to the gear.
2. Install the idler gear shaft (3) to the gear.
3. Install the idler gear asm to the gearcase.
4. Tighten the bolt to the specified torque.

N·m (kgf·m/lb.ft)

Bolt Torque	98 – 118 (10.0 – 12.0/72 – 87)
-------------	--------------------------------

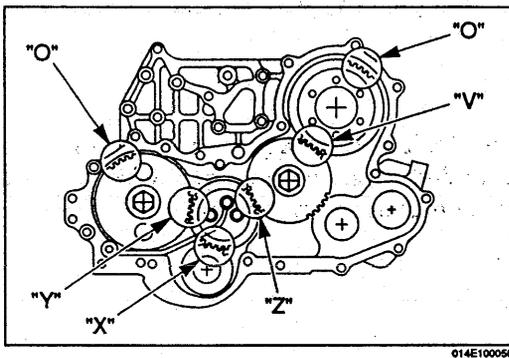

Timing gear mark

Align the timing mark X, Y, Z.

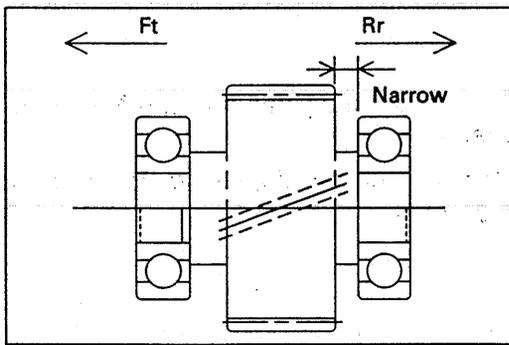

Idler gear C

Sub-assemble the bearing to the gear.

- Apply load only on the inner race of bearing, when the bearing will be pressed to the gear.

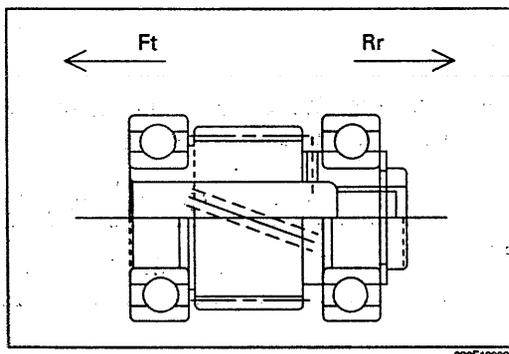

PTO gear

Sub-assemble the bearing to the gear.

- Apply load only on the inner race of bearing, when the bearing will be pressed to the gear.

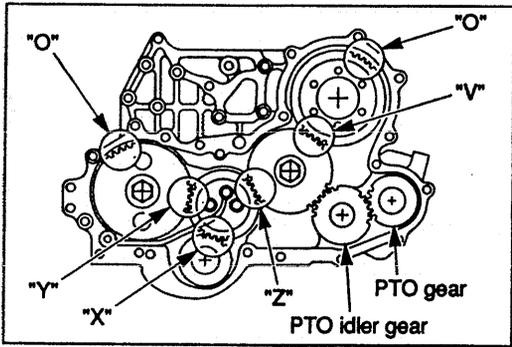

013E100022

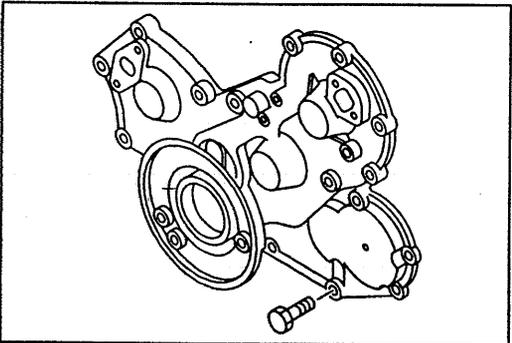

013E100022

Gearcase PTO

Install the idler gear C and PTO gear to the gearcase.

Gearcase cover

1. Apply sealant to the gearcase.
2. Install the gearcase cover to the gearcase.
3. Tighten the bolts to the specified torque.

N-m (kgf-m/lb.ft)

Bolt Torque	M8	14-24 (1.4-2.4/10-17)
	M12	75-91 (7.6-9.3/55-67)

4. Install the oil feed pipe to the gearcase cover.

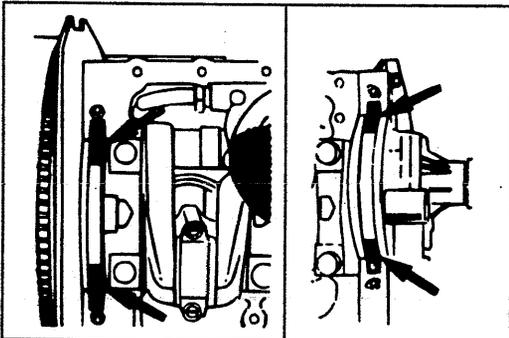

013E100004

Oil pan

1. Apply sealant TB1207B or equivalent to the No.5 bearing cap arches, the bearing grooves, and the timing gearcase arches as shown in the illustration.

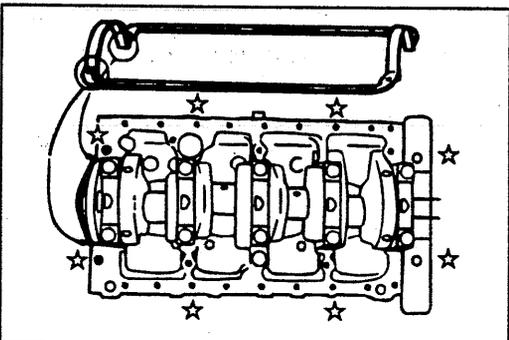

013E100005

2. Fit the gasket rear lipped portion into the No.5 bearing cap groove.

Be absolutely sure that the lipped portion is fitted snugly in the groove.

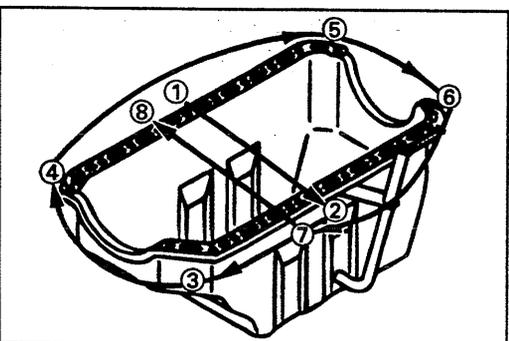

013E100007

3. Tighten the oil pan nuts and bolts to the specified torque a little at a time in the sequence shown in the illustration.

N-m (kgf-m/lb.ft)

Oil Pan Nut and Bolt Torque	14 - 24 (1.4 - 2.4/10 - 17)
-----------------------------	-----------------------------

ERRATA

1. 4JG2 (IDE-2290, PAGE 12)

CORRECTION

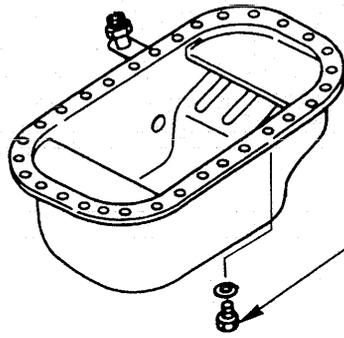

0.6 - 1.0 (4.3 - 7.2/6 - 10)
↓
0.6 - 1.0 (4.4 - 7.2/5.9 - 9.8)

2. 4JG2 (IDE-2290, PAGE 104)

Oil pan fixing torque in case of the engine specification which is not equipped with the crankcase.

CORRECTION

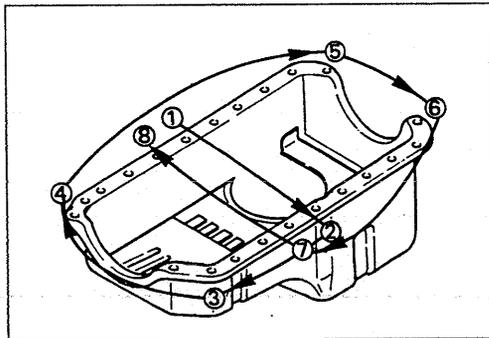

3) Tighten the oil pan bolts to the specified torque a little at a time in the sequence shown in the illustration.

Oil Pan Bolt Torque	kgf·m(lb.ft/N·m)
0.6 - 1.0(4.3 - 7.2/6 - 10)	
↓	
1.4 - 2.4(10.1 - 17.3/13.7 - 23.5)	

3. 4JG2 (IDE-2290, PAGE 104)

Oil pan fixing torque in case of the engine specification which is equipped with the crankcase.

ADDITION

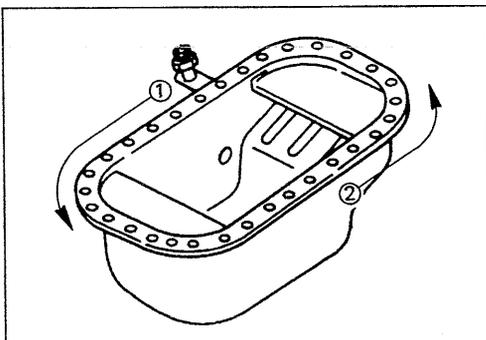

Tighten the oil pan bolts to the specified torque starting from ① and ② alternately, as shown in the illustration and, work out toward the arrow directions.

Oil Pan Bolt Torque	kgf·m (lb.ft/N·m)
0.6 - 1.0(4.4 - 7.2/5.9 - 9.8)	

Copyright reserved for this manual may not be reproduced or copied, in whole or in part, without the written consent of ISUZU MOTORS LIMITED.

WORKSHOP MANUAL (INDUSTRIAL)

4JG2

(IDE-2290)

Issued by

ISUZU MOTORS LIMITED

ENGINE SALES PLANNING OFFICE

6-26-1, Minami-oi, Shinagawa-ku, Tokyo, 140, Japan

TEL 03-5471-1111

First edition Apr., 1996

604-01-200K